



**Hitachi Freedom Storage™  
Lightning 9900™ V Series**

**Remote Console – Storage Navigator™  
User's Guide**



© 2002 Hitachi Data Systems Corporation, ALL RIGHTS RESERVED

**Notice:** No part of this publication may be reproduced or transmitted in any form or by any means, electronic or mechanical, including photocopying and recording, or stored in a database or retrieval system for any purpose without the express written permission of Hitachi Data Systems Corporation.

Hitachi Data Systems reserves the right to make changes to this document at any time without notice and assumes no responsibility for its use. Hitachi Data Systems products and services can only be ordered under the terms and conditions of Hitachi Data Systems' applicable agreements. All of the features described in this document may not be currently available. Refer to the most recent product announcement or contact your local Hitachi Data Systems sales office for information on feature and product availability.

This document contains the most current information available at the time of publication. When new and/or revised information becomes available, this entire document will be updated and distributed to all registered users.

## Trademarks

Hitachi Data Systems is a registered trademark and service mark of Hitachi, Ltd. The Hitachi Data Systems design mark is a trademark and service mark of Hitachi, Ltd.

Hi-Track is a registered trademark of Hitachi Data Systems Corporation.

Hitachi Graph-Track, Hitachi Freedom Storage, Hi-Star, FlashAccess, ShadowImage, CruiseControl, Dynamic Link Manager, Just In Time Storage, RapidXchange, SANtinel, and Hitachi Lightning 9900V are trademarks of Hitachi Data Systems Corporation.

S/390, S/380, AIX, and FICON, and ESCON are registered trademarks of International Business Machines Corporation.

Internet Explorer, Windows 95, Windows 98, Windows ME, Windows NT, Windows XP, and Windows 2000 are trademarks or registered trademarks of Microsoft Corporation.

HP-UX is a registered trademark of Hewlett-Packard Company.

Solaris, Java, Java Virtual Machine (JVM) and Java Runtime Environment™ (JRE) are trademarks or registered trademarks of Sun Microsystems, Inc.

All other brand or product names are or may be registered trademarks, trademarks or service marks of and are used to identify products or services of their respective owners.

## Notice of Export Controls

Export of technical data contained in this document may require an export license from the United States government and/or the government of Japan. Contact the Hitachi Data Systems Legal Department for any export compliance questions.

## Document Revision Level

Revision	Date	Description
MK-92RD101-P	March 2002	Preliminary Release
MK-92RD101-0	April 2002	Initial Release
MK-92RD101-1	April 2002	Revision 1; supersedes and replaces MK-92RD101-0

## Source Documents for This Revision

Bas45d1b (February, 2002)

Web45d0 (March, 2002)

Web45d0a (April, 2002)

## Changes in this Revision

- Corrected number of disk array frames from six to four (sections 1.2 and 1.5).
- Corrected reference to 18-GB disk drive (section 1.5).
- Corrected number of logical control units from sixteen to 32 (section 1.5).
- Corrected Table 1.1 (Device Numbers for each CU) to reflect 32 CUs.

## Referenced Documents

Hitachi Lightning 9900V documentation referenced in this document:

- *Hitachi Freedom Storage™ Lightning 9900™ V Series User and Reference Guide (MK-92RD100)*
- *Hitachi Freedom Storage™ Lightning 9900™ V Series LUN Manager User's Guide (MK-92RD105)*
- *Hitachi Freedom Storage™ Lightning 9900™ V Series LUN Expansion (LUSE)/Virtual LVI/LUN (VLL) User's Guide (MK-92RD104)*
- *Hitachi Freedom Storage™ Lightning 9900™ V Series FlashAccess User's Guide (MK-92RD102)*
- *Hitachi Freedom Storage™ Lightning 9900™ V Series Performance Monitor User's Guide (MK-92RD133)*
- *Hitachi Freedom Storage™ Lightning 9900™ V Series CruiseControl User's Guide (MK-92RD106)*
- *Hitachi Freedom Storage™ Lightning 9900™ V Series Priority Access User's Guide (MK-92RD117)*
- *Hitachi Freedom Storage™ Lightning 9900™ V Series TrueCopy User's Guide (MK-92RD108)*
- *Hitachi Freedom Storage™ Lightning 9900™ V Series ShadowImage User's Guide (MK-92RD110)*
- *Hitachi Freedom Storage™ Lightning 9900™ V Series TrueCopy - S/390® User's Guide (MK-92RD107)*
- *Hitachi Freedom Storage™ Lightning 9900™ V Series ShadowImage - S/390® User's Guide (MK-92RD109)*
- *Hitachi Freedom Storage™ Lightning 9900™ V Series Parallel Access Volume User's Guide (MK-92RD118)*
- *Hitachi Freedom Storage™ Lightning 9900™ V Series Hitachi Remote Console - Storage Navigator Error Codes (MK-92RD132)*



## Preface

This *Hitachi Freedom Storage™ Lightning 9900™ V Series Remote Console - Storage Navigator™ User's Guide* provides instructions for installing the 9900V Remote Console and using the web client Java™ applet program for the 9900V subsystem. Please read this manual carefully to understand how to manipulate your 9900V storage subsystems using your Remote Console, and maintain a copy that is accessible from your Remote Console for reference purposes.

This user's guide assumes that:

- the user has a background in data processing and understands direct-access storage device (DASD) subsystems and their basic functions,
- the user is familiar with the Hitachi 9900V array subsystem, and the user is familiar with the Windows NT® or Windows® 2000 operating systems.

For further information on the 9900V subsystem, please refer to the *Hitachi Freedom Storage™ Lightning 9900™ V Series User and Reference Guide* (MK-92RD100), or contact your Hitachi Data Systems account team.

**Note:** The term "9900V" refers to the entire Lightning 9900™ V Series subsystem family, unless otherwise noted.

**Note:** The use of the Lightning 9900™ V Series Remote Console, the web client Java™ applet and any other optional functions is governed by the terms of the applicable license and other agreement(s) with Hitachi Data Systems.

**Note:** This product includes software developed by the Apache Group for use in the Apache HTTP server project (<http://www.apache.org/>)

### Microcode Level

This document revision applies to 9900V microcode versions 21-01-XX and higher.

#### COMMENTS

Please send us your comments on this document: [doc.comments@hds.com](mailto:doc.comments@hds.com).

Make sure to include the document title, number, and revision.  
Please refer to specific page(s) and paragraph(s) whenever possible.  
(All comments become the property of Hitachi Data Systems Corporation.)

**Thank you!**





# Contents

<b>Chapter 1</b>	<b>Overview of Lightning 9900™ V Series Remote Console – Storage Navigator Operations</b>	<b>1</b>
1.1	9900™ V Series Web Server and Web Client	1
1.2	Lightning 9900™ V Series Subsystem	4
1.3	User Access Control	4
1.4	Storage Device List and User Account List	5
1.5	Important Terms and Concepts	6
<b>Chapter 2</b>	<b>Installation Requirements and Procedures</b>	<b>9</b>
2.1	System Requirements	9
2.2	Setting Up the Remote Console	11
2.3	Using the Remote Console	12
2.3.1	Remote Console Conventions	12
2.3.2	Keystroke and Navigation Conventions for the Remote Console	13
2.4	Starting Up and Logging On To the 9900V	14
2.5	Changing Between View Mode and Modify Mode	18
2.6	License Keys	20
2.7	Enabling and Disabling Options on the Remote Console	22
2.7.1	Remote Console Options	22
2.7.2	License Key/SNMP/Just in Time Panel, License Key Tab	23
2.7.3	Enabling a Remote Console Option Using a License Key Code	29
2.7.4	Enabling Remote Console Options Using a License Key File	31
2.7.5	Disabling Remote Console Options	32
<b>Chapter 3</b>	<b>Lightning 9900™ V Series Remote Console Operations</b>	<b>33</b>
3.1	The Remote Console Main Panel	34
3.1.1	Remote Console Main Panel, Information Tab	34
3.1.2	Remote Console Main Panel, Status Tab	40
3.1.3	Launching the Desired Option	43
3.2	Editing the Storage Device List (Administrator Only)	44
3.2.1	The Storage Device List Panels	44
3.2.2	Adding a Storage Device	46
3.2.3	Changing a Storage Device Entry	48
3.2.4	Deleting a Storage Device Entry	49
3.3	Editing the User Account List (Administrator Only)	50
3.3.1	Control Panel, User Entry Tab	50
3.3.2	Adding a New User Entry	52
3.3.3	Changing a User Entry	54
3.3.4	Changing a User Password	56
3.3.5	Deleting a User Entry	57
3.4	Setting the Remote Console Environment Parameters (Administrator Only)	58
3.5	Viewing the Remote Console Log Information (Administrator Only)	62
3.6	Downloading the Log and Configuration Files (Administrator Only)	64
3.7	Restoring Backup Files (Administrator Only)	69
3.7.1	Control Panel, Restore Tab	69
3.7.2	Restoring Backup Files	70
3.8	Viewing Your Own User Permissions and Changing Your Own Password	73

3.8.1	Viewing Your User Permissions.....	73
3.8.2	Changing Your Password .....	74
3.9	Extending Cache Memory and LUs by Using the Just in Time Storage Functions.....	75
3.9.1	License Key/SNMP/Just in Time Panel, Just in Time Tab .....	76
3.9.2	Extending LUs Using the Just in Time Storage LUN Function.....	78
3.9.3	Extending Cache Memory Using Just in Time Storage Cache Function .....	79
3.10	Downloading Trace Files Using the FD Dump Tool .....	80
3.11	Exporting Data Using the Export File Function .....	85
3.12	Uploading Files to SVP Using the FTP Client Function.....	88
<b>Chapter 4</b>	<b>Setting SNMP Agent Properties .....</b>	<b>91</b>
4.1	Overview of SNMP Agent Properties .....	91
4.2	The <b>SNMP Information tab</b> .....	92
4.3	SNMP Agent Operations.....	94
4.3.1	Adding SNMP Manager IP Addresses .....	94
4.3.2	Deleting SNMP Manager IP Addresses .....	95
4.3.3	Adding A Community Name.....	96
4.3.4	Deleting A Community Name .....	98
4.3.5	Changing A Community Name .....	99
4.3.6	Adding Community IP Addresses .....	101
4.3.7	Deleting A Community IP Address .....	102
<b>Chapter 5</b>	<b>Troubleshooting .....</b>	<b>103</b>
5.1	Troubleshooting .....	103
5.2	Calling the Hitachi Data Systems Technical Support Center .....	105
	<b>Glossary, Acronyms, and Abbreviations .....</b>	<b>107</b>

# List of Figures

Figure 1.1	Illustration of SVP and Remote Console Configuration .....	2
Figure 2.1	Selecting the Desired SVP (Web Server) From the Storage Device List .....	14
Figure 2.2	Storage Device List Panel .....	16
Figure 2.3	Logon Panel.....	17
Figure 2.4	View Mode .....	19
Figure 2.5	Mode Changing Confirmation Message .....	19
Figure 2.6	Modify Mode .....	19
Figure 2.7	Overview of License Keys and Option Installation.....	20
Figure 2.8	License Key/SNMP/Just in Time Panel, License Key Tab.....	23
Figure 2.9	License Key Table (From the License Key/SNMP/Just in Time Panel, License Key Tab).....	24
Figure 2.10	Total Storage Graphic (From the License Key/SNMP/Just in Time Panel, License Key Tab).....	25
Figure 2.11	License Install Box (From the License Key/SNMP/Just in Time Panel, License Key Tab).....	26
Figure 2.12	Install, Deinstall, Apply and Cancel Buttons (From the License Key/SNMP/ Just in Time Panel, License Key Tab) .....	27
Figure 2.13	Apply Confirmation Message .....	30
Figure 2.14	Cancel Confirmation Message.....	30
Figure 3.1	Remote Console Main Panel, Information Tab .....	34
Figure 3.2	Option Buttons (From the Remote Console Main Panel, Information Tab) .....	35
Figure 3.3	Subsystem Information Icons (From the Remote Console Main Panel, Information Tab).....	37
Figure 3.4	Device Information Box (From the Remote Console Main Panel, Information Tab) .....	38
Figure 3.5	Device View, Apply Button and Cancel Buttons (From the Remote Console Main Panel, Information Tab) .....	39
Figure 3.6	Remote Console Main Panel, Status Tab .....	40
Figure 3.7	Controller Status Box (From the Remote Console Main Panel, Status Tab) .....	41
Figure 3.8	Disk Array Status Box (From the Remote Console Main Panel, Status Tab) .....	42
Figure 3.9	Status History Box (From the Remote Console Main Panel, Status Tab) .....	42
Figure 3.10	Logon Panel.....	44
Figure 3.11	Storage Editor Logon Panel .....	44
Figure 3.12	Storage Entry Panel .....	45
Figure 3.13	Change Storage Entry Panel.....	47
Figure 3.14	Register Device Confirmation Message .....	47
Figure 3.15	Registration Complete Message .....	47
Figure 3.16	Delete Device Confirmation Message.....	49
Figure 3.17	Control Panel, User Entry Tab.....	50
Figure 3.18	User Entry Panel .....	53
Figure 3.19	Register User Confirmation Message.....	53
Figure 3.20	User List Editor Panel (Permission Tab).....	55
Figure 3.21	Change Permission Confirmation Message .....	55
Figure 3.22	User Entry Panel (Password Tab).....	56
Figure 3.23	Change Password Confirmation Message .....	56
Figure 3.24	Delete User Confirmation Message .....	57

Figure 3.25	Control Panel, Set Environment Tab .....	58
Figure 3.26	Control Panel, Log Tab .....	62
Figure 3.27	Control Panel, Download Tab .....	64
Figure 3.28	Download Panel .....	66
Figure 3.29	File Download Panel .....	67
Figure 3.30	Save As Panel .....	67
Figure 3.31	Download Complete Panel .....	68
Figure 3.32	Control Panel, Restore Tab .....	69
Figure 3.33	Backup File Not Found Panel .....	71
Figure 3.34	Password Check Panel .....	71
Figure 3.35	File Restoration Confirmation Panel .....	72
Figure 3.36	User Control Panel, Permission Tab .....	73
Figure 3.37	User Control Panel, Password Tab .....	74
Figure 3.38	License Key/ Just in Time/SNMP Panel, Just in Time Tab .....	76
Figure 3.39	On-Demand Menu Commands (Left: Changing ON to OFF, Right: Changing OFF To ON) (From the License Key/ Just in Time/SNMP Panel, Just in Time Tab) .....	78
Figure 3.40	Just in Time Confirmation Message .....	78
Figure 3.41	Download Trace Files Logon Panel .....	81
Figure 3.42	Download Trace Files Panel (Selecting Trace Files) .....	81
Figure 3.43	Compressing Files Panel .....	82
Figure 3.44	Download Trace Files Download Panel .....	82
Figure 3.45	File Download Panel .....	83
Figure 3.46	Save As Panel .....	83
Figure 3.47	Download Complete Panel .....	84
Figure 3.48	Export Data Files Panel (Selecting Data) .....	86
Figure 3.49	Export Data Files Panel (New Data) .....	86
Figure 3.50	Export Data Files Panel (Export Data) .....	87
Figure 3.51	File Download (FTP Client) Panel .....	89
Figure 3.52	Sample Display on Windows® Explorer .....	89
Figure 3.53	Upload Panel .....	90
Figure 3.54	Open Panel by Reference Button .....	90
Figure 3.55	Success Panel .....	90
Figure 4.1	Illustration of 9900V SNMP Environment .....	91
Figure 4.2	License Key/SNMP/Just in Time Panel, SNMP Information tab .....	92
Figure 4.3	Setting IP Address (Right: Before Setting, Left: After Setting) (From the License Key/ Just in Time/SNMP Panel, SNMP Information tab) .....	94
Figure 4.4	Delete IP Address Pop-Up Command .....	95
Figure 4.5	Add Community Pop-Up Menu .....	97
Figure 4.6	Add Community Panel .....	97
Figure 4.7	Community and Trap Popup Menu (Delete Community Selected) .....	98
Figure 4.8	Change Community Pop-Up Menu .....	100
Figure 4.9	Change Community Panel .....	100
Figure 4.10	Community and Trap Popup Menu (Add IP Address Selected) .....	101
Figure 4.11	Add IP Address Panel .....	101
Figure 4.12	Delete IP Address Pop-Up Menu .....	102

## List of Tables

Table 1.1	Device Numbers for Each CU.....	7
Table 2.1	9900V Remote Console Requirements.....	10
Table 2.2	Specifications and Restrictions Concerning Logon Operations .....	15
Table 2.3	Remote Console Options.....	22
Table 2.4	License Key Status Icon.....	28
Table 3.1	Disk Controller and Disk Array Unit Error Conditions .....	43
Table 3.2	SIM Severity Levels and Icons .....	43
Table 5.1	General Error Conditions .....	104



# Chapter 1 Overview of Remote Console – Storage Navigator Operations

## 1.1 9900™ V Series Web Server and Web Client

The Lightning 9900™ V Series Remote Console - Storage Navigator consists of a group of Java™ applet programs. The 9900V SVP is the notebook computer that is inside each subsystem, which uses Java Virtual Machine™ (JVM™) to function as a web server. The 9900V Remote Console functions as a web client. Each time you log onto the Remote Console and connect to the SVP, a Java™ applet program is downloaded from the SVP to the Remote Console. The Remote Console communicates directly with the SVP of each attached subsystem to obtain subsystem configuration and status information and send user-requested commands to the subsystem. The Web Client Java™ applet program runs on a web browser to provide a user-friendly interface for the 9900V Web Client functions.

The 9900V can be connected to two LANs. The 9900V internal LAN is a private LAN that is used to connect the SVPs of multiple subsystems. Your intranet is a public LAN that allows you to access one or more SVPs from individual Remote Consoles. This configuration allows you to easily access and control the registered 9900V subsystems. In a SAN environment, where several subsystems may be connected together, you must designate a primary SVP, which can be either any SVP connected to a 9900V subsystem or a web server with the exact same configuration as an SVP (see section 2.1).

Figure 1.1 shows an example of Remote Console (web client) and SVP (web server) configuration.

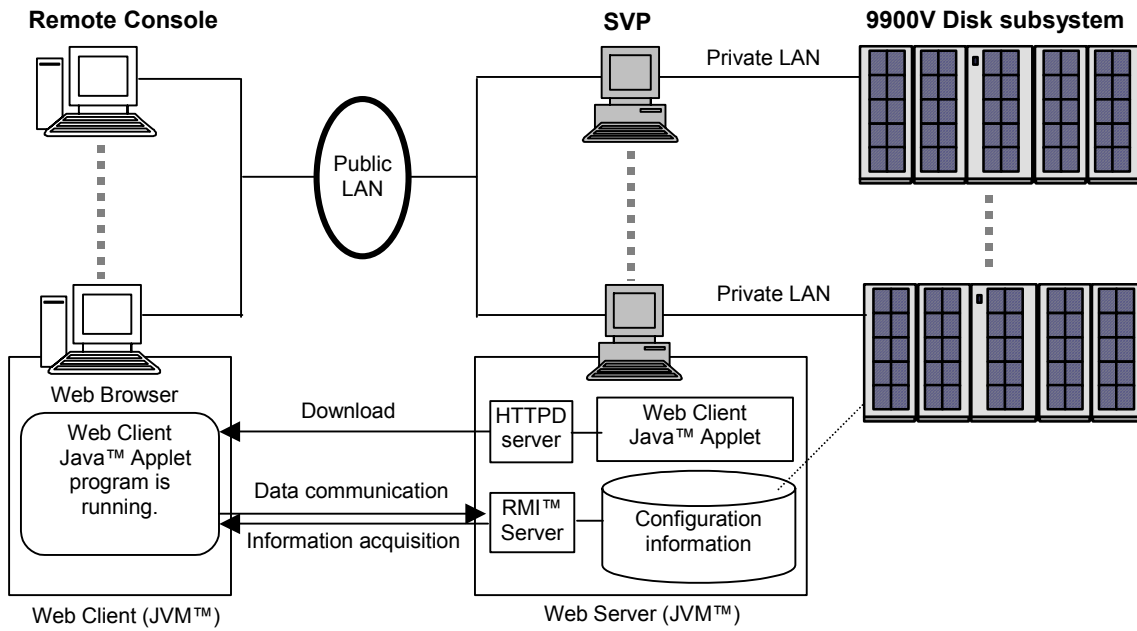

Figure 1.1 Illustration of SVP and Remote Console Configuration



The 9900V Web Client Java™ applet program displays the configuration information for the attached 9900V subsystems and enables you to perform the following types of operations:

- Enabling and disabling options (see sections 2.5 through 2.7).
- Viewing the detailed information of the subsystem (see section 3.1.2).
- Launching the desired option (see section 3.1.3).
- Editing the storage device list (administrator only) (see section 3.2).
- Editing the user account list (administrator only) (see section 3.3).
- Setting the Remote Console environment parameters (administrator only) (see section 3.4).
- Viewing the Remote Console log information (administrator only) (see section 3.5).
- Downloading the log and configuration files (administrator only) (see section 3.6).
- Restoring the storage device list, the user account list and the environment parameters (administrator only) (see section 3.7),
- Viewing the Remote Console information and changing the password (see section 3.8).
- Extending cache memory and LUNs using the Just In Time functions (see section 3.9).
- Downloading Remote Console trace files using FD Dump Tool (see section 3.10).
- Exporting data to files using the Export File function (see section 3.11).
- Uploading files to the SVP using the FTP Client function (see section 3.12).
- Setting SNMP Agent properties (see Chapter 4).

This user's guide does not cover all 9900V Remote Console features or Web Client Java™ applet options (see Table 2.3). Please refer to the appropriate user's guide for more details about 9900V feature options. For further information on 9900V features and functions, contact your Hitachi Data Systems account team.

## 1.2 Lightning 9900™ V Series Subsystem

The Hitachi 9900V subsystem offers the following consolidated features to implement more efficient storage management systems in a large-scale storage area network (SAN) environment:

- **Improved capacity and scalability.** The subsystem supports up to 8,192 logical device (LDEV) addresses per subsystem. If you use 180-GB disk drives the subsystem capacity can be expanded up to 138 TB.
- **Continuous data availability.** The 9900V subsystem employs the Hierarchical Star Network (Hi-Star™) architecture to improve total performance of internal data transfer. Hi-Star™ architecture uses high-speed crossbar switches among processors on channel adapter boards, processors on disk adapter boards, and cache memory. The 9900V subsystem also provides up to 64 fibre-channel interface paths or 32 serial-interface paths, and enables simultaneous data transfer through each path.
- **Connectivity for SAN infrastructure.** The 9900V can be configured for all-mainframe, all-open, or multiplatform operations. The 9900V subsystem supports fibre-channel ports. The 9900V subsystem provides variety of feature options to meet SAN requirements
- **Subsystem scalability.** The architecture of the 9900V subsystem accommodates scalability to meet a wide range of capacity and performance requirements. The 9980V model includes one controller frame containing the control and operational components of the subsystem, and up to four disk array frames containing the storage components (disk drive arrays) of the subsystem. The 9970V model includes one frame containing the controller and disk components of the subsystem.

For further information on the 9900V subsystem, refer to the *Hitachi Freedom Storage™ Lightning 9900™ V Series User and Reference Guide (MK-92RD100)*, or contact your Hitachi Data Systems account team.

## 1.3 User Access Control

The web client Java™ applet program provides three basic levels of user access: administrator (root) access, restricted (write) access, and ordinary user (view) access. Administrators have write access to all Remote Console functions. Certain functions are restricted to administrators, including the ability to configure the Remote Console for controller, user, and option functions. The remaining functions are referred to as restricted functions, and ordinary users can be assigned write permission to one or more of these functions. The ability to assign a user different access permissions for each individual function allows maximum flexibility and control over the 9900V Remote Console functions.

See section 3.3.2 for instructions on assigning write permissions for restricted functions.

## 1.4 Storage Device List and User Account List

The Remote Console administrator is responsible for registering storage devices with the primary SVP. This information is compiled into the storage device list, which includes information such as device name, IP address, and device location. See section 3.2 for more details. You can display the storage device list on your web browser by accessing the following URL (where xxx.xxx.xxx.xxx is the IP address of the primary SVP):

```
http://xxx.xxx.xxx.xxx/cgi-bin/utility/sjc0000.cgi
```

The Remote Console Administrator is also responsible for entering users for each subsystem into the user account list, which is stored in that subsystem's SVP. The user account list includes information such as user ID, password, and write permission for each 9900V option. See section 3.3 for more details.

## 1.5 Important Terms and Concepts

The 9900V Remote Console user should be familiar with the following terms and concepts:

- **Disk controller.** The 9900V subsystem has one disk controller that controls all data access and storage operations. The 9900V subsystem provides up to 32 logical control unit (CU) images and supports 3990-6, 3990-6E, and 2105-F20 emulation.  
**Note:** 3390-3 and 2105-E20 emulation are not supported.
- **Disk array unit.** The 9900V subsystem has up to four disk array frames containing the storage components (disk drive arrays) of the subsystem. The minimum subsystem consists of one frame containing both the disk controller and disk components.
- **Parity group.** A parity group is a set of hard disk drives that have the same capacity and are treated as one group. For example, a parity group of 36-GB disk drives in a RAID-5 configuration consists of four disk drives (3 data and 1 parity). A parity group contains both user data and parity information, and the parity information is used to automatically reconstruct the user data if one of the disk drives in the parity group becomes unavailable.
- **LDEV (Logical Device).** The 9900V subsystem supports a maximum of 8192 LDEVs. An LDEV used by mainframe hosts can be called a device, logical volume image (LVI) or a volume.
- **LU (Logical Unit).** An LDEV used by open-system hosts is called an LU. Open-system fibre interfaces access LUs that are mapped to one or more LDEVs. The number of possible LUs depends on the size required by the user.
- **Java™ Applet program.** The 9900V Remote Console is provided as a Java™ applet program. When a Remote Console user accesses and logs on to the desired SVP, the web client Java™ applet is downloaded from the SVP to the Remote Console. The web client Java™ applet program runs on a web browser on the Remote Console.
- **RMI™ (Remote Method Invocation).** RMI™ is a remote procedure call that allows Java™ objects stored in the network to be run remotely. In the 9900V Remote Console network environment, the Remote Console downloads Java™ objects from the SVP.

- **CU (Control Unit).** The 9900V subsystem supports a maximum of 32 logical CU images. Each CU image controls up to 256 LDEVs. The CUs are numbered sequentially from 0-F. LDEVs are accessed within the 9900V subsystem by a combination of CU number (0-F) and device number (00-FF). Table 1.1 lists the possible device numbers for each CU.

**Table 1.1 Device Numbers for Each CU**

CU Number	Possible Device Numbers	CU Number	Possible Device Numbers
0	0:00 to 0:FF	10	10:00 to 10:FF
1	1:00 to 1:FF	11	11:00 to 11:FF
2	2:00 to 2:FF	12	12:00 to 12:FF
3	3:00 to 3:FF	13	13:00 to 13:FF
4	4:00 to 4:FF	14	14:00 to 14:FF
5	5:00 to 5:FF	15	15:00 to 15:FF
6	6:00 to 6:FF	16	16:00 to 16:FF
7	7:00 to 7:FF	17	17:00 to 17:FF
8	8:00 to 8:FF	18	18:00 to 18:FF
9	9:00 to 9:FF	19	19:00 to 19:FF
A	A:00 to A:FF	1A	1A:00 to 1A:FF
B	B:00 to B:FF	1B	1B:00 to 1B:FF
C	C:00 to C:FF	1C	1C:00 to 1C:FF
D	D:00 to D:FF	1D	1D:00 to 1D:FF
E	E:00 to E:FF	1E	1E:00 to 1E:FF
F	F:00 to F:FF	1F	1F:00 to 1F:FF



# Chapter 2 Installation Requirements and Procedures

## 2.1 System Requirements

The 9900V web client Java™ applet program is downloaded from the SVP to the Remote Console. The applet runs on the web browser of the Remote Console, and communicates with the attached 9900V subsystems via the TCP/IP network.

The 9900V web client Java™ applet program has the following system requirements:

- Hitachi 9900V subsystem(s). The 9900V Remote Console can be attached to multiple subsystems of the same type (9900V). **Note:** If you want to connect to more than one subsystem, you must log on to the SVP of each of the subsystems you want to connect, and use individual web client Java™ applet programs on separate web browser windows.
- 9900V Remote Console(s). Up to 32 Remote Console users can concurrently access the same 9900V subsystem, but only one user can be in **Modify** mode at a time. Users in **View** mode can view the information for that subsystem, but cannot make any changes. You can see who is currently using the Remote Console by checking the logon access log (see section 3.5).
- LAN cables and connection:
  - Thinnet coaxial cable. For twisted-pair connections, contact the Hitachi Technical Support Center for assistance.
  - The total length of the LAN cables must not be greater than 185 meters (607 feet).
- 9900V license keys for optional features, including the Web Client Java™ applet.

**Table 2.1 9900V Remote Console Requirements**

Item	Specification
Operating system	Windows NT <sup>®</sup> or Windows <sup>®</sup> 2000
Processor (CPU)	Pentium <sup>®</sup> 400 MHz or better
Memory (RAM)	128 MB or more
Available hard drive space	150 MB or more
Monitor	SVGA with High Color (16-bit) or better. <b>Note:</b> Set the display properties to small fonts.
Keyboard and mouse	For most Remote Console Operations, you cannot scroll using the mouse. You must either right-click or left-click.
3.5-inch floppy disk drive	
CD-ROM drive	
Ethernet LAN card for TCP/IP network	100BASE-T (recommended) or 10BASE-T
Web browser	Internet Explorer <sup>®</sup> 5.0, 5.5 and 6.0
Java Runtime Environment <sup>™</sup> (JRE <sup>™</sup> )	JRE <sup>™</sup> 1.3.1 or higher. <b>Note:</b> You can download JRE1.3.1_01 from the following site: <a href="http://java.sun.com/products/archive/index.html">http://java.sun.com/products/archive/index.html</a>



## 2.2 Setting Up the Remote Console

The Hitachi Data Systems representative will install the SVP software and LAN cabling. You will need to document the serial numbers (SNs) and IP addresses of each 9900V subsystem, because these numbers are required for Remote Console operations.

**Note:** It is important to verify that you have a unique IP address for each SVP, to avoid any conflicts. If a conflict occurs, determine the SVP IP addresses of all connected subsystems and obtain a unique IP address for the desired 9900V subsystem. You can also contact your Hitachi Data System support center for assistance in assigning IP addresses.

To connect to the desired 9900V SVP and use the web client Java™ applet program, a web browser is required on the Remote Console. For instructions on editing the storage device list, see section 3.2.





To configure your web browser:

1. Make sure that the Remote Console is connected to a network via a LAN.  
**Caution:** Using a modem for network connections is not supported.
2. Make sure that cookies are enabled on the browser.
3. Install Java Runtime Environment™ 1.3 or higher. If the download does not occur automatically the first time you log into the Remote Console web server, you can download JRE™ from the following site:



<http://java.sun.com/products/archive/index.html>

## 2.3 Using the Remote Console

### 2.3.1 Remote Console Conventions

- On most Remote Console panels, if you specify different settings for the values on the panel, the text color of that value changes to blue or the icon will change, but the changes are not implemented until you select the **Apply** button.
- You can create and store up to 1000 settings or operations before actually applying them to the 9900V subsystem. To avoid a possible error, do not apply more than 1,000 settings at a time.
- The layout of a Remote Console panel is reset when you select the **Apply** button, the **Refresh** button () , or when you switch tabs.
- When the microprogram is being updated on the SVP, you must exit and restart all web browsers on the Remote Console.
- If a Remote Console user is in **Modify** mode and is applying settings, you will not be able to log onto the Remote Console until after those settings have been applied. A wait of longer than five minutes indicates an abnormal end, in which case you need to exit and restart the browser.
- When an internal process is being executed on the SVP (e.g., a configuration change, option check, or an operational information acquisition), Remote Console processing might be temporarily delayed.
- If you reset the time of the clock on the Remote Console, you will need to clear the existing temporary Internet files of your web browser before logging on to the Remote Console.
- If you request a change to the subsystem configuration while another change is being made, you will get an error message.
  - If the error occurs while you are logging on or selecting the **Apply** button to implement changes, wait for a few minutes and retry the operation.
  - If the error occurs while you are selecting the **Option** button () , switching to **Modify** mode () or switching tabs, wait for a few minutes, select the **Refresh** button () , and then retry the operation.
- If you remain in **Modify** mode for a certain period of time without making any changes (the default is 30 minutes), the subsystem will release the **Modify** mode and you will return to **View** mode see section 3.4.

## 2.3.2 Keystroke and Navigation Conventions for the Remote Console

- In general, you can select an object on a panel by clicking the mouse. Certain commands can be displayed by right-clicking an object. In some cases you can use the right mouse button to drag and drop an item. This will be noted in the instructions for each operation.
- You cannot use the **Home**, **End**, or **Delete** keys for Remote Console operations.
- Always use the **Exit** button () to close Remote Console panels. For example, do not close Remote Console panels by:
  - Selecting the **Close** button () on the panel,
  - Using the **File** or **Exit** commands,
  - Typing **Alt+F4**.
  - **Note:** If you accidentally close the panels using one of these methods, wait for an RMI™ time-out and then restart the Remote Console (see section 3.4).
- Do not use function or shortcut keys such as **F5**, **Ctrl+F**, **Esc**, and **Ctrl+A** for Remote Console operations, because these may have unintended consequences. For example, the **F5** key will exit and restart the Remote Console.
- For Java™ applet security, you cannot copy and paste objects (text) from other applications during Remote Console operations.
- After dragging and dropping objects to another location or area, you might not be able to use the scroll bar on that location or area. If this occurs, close all panels and then log in again.
- You cannot drop an object to an area or location where no object exists. **Note:** Even if you try to drop an object to an invalid area or location, no warning icon is displayed.
- To drag and drop adjacent objects, use the **Shift** key to select a group of objects, then hold down the **Ctrl** key while you select the last object in the group and drag and drop the objects.
- To drag and drop non-adjacent objects, use the **Ctrl** key to select the group of objects, and continue to hold it down while you drag and drop the objects.
- When you try to drag and drop multiple objects, the items may remain selected. If this happens, repeat the drop operation.

## 2.4 Starting Up and Logging On To the 9900V

**Important:** Because the initial user ID has administrator-level access, one of the first tasks for the 9900V Remote Console administrator should be to change the password, in order to maintain protection of the administrator-only and restricted functions. If you are logging on to the 9900V for the first time, use the initial user ID (root) and password (root) to log on as an administrator. All user IDs and passwords are case-sensitive. If the administrator password is lost or forgotten, you must call the Hitachi Data Systems Technical Support Center in order to regain access to the restricted functions.

All 9900V Remote Console (web client) users are required to log on to the Remote Console SVP (web server) with a valid user ID and password before executing the web client Java™ applet program. You must have administrator access to register Remote Console users and assign or modify user access (see section 3.3).

Figure 2.1 shows an overview of the login process.

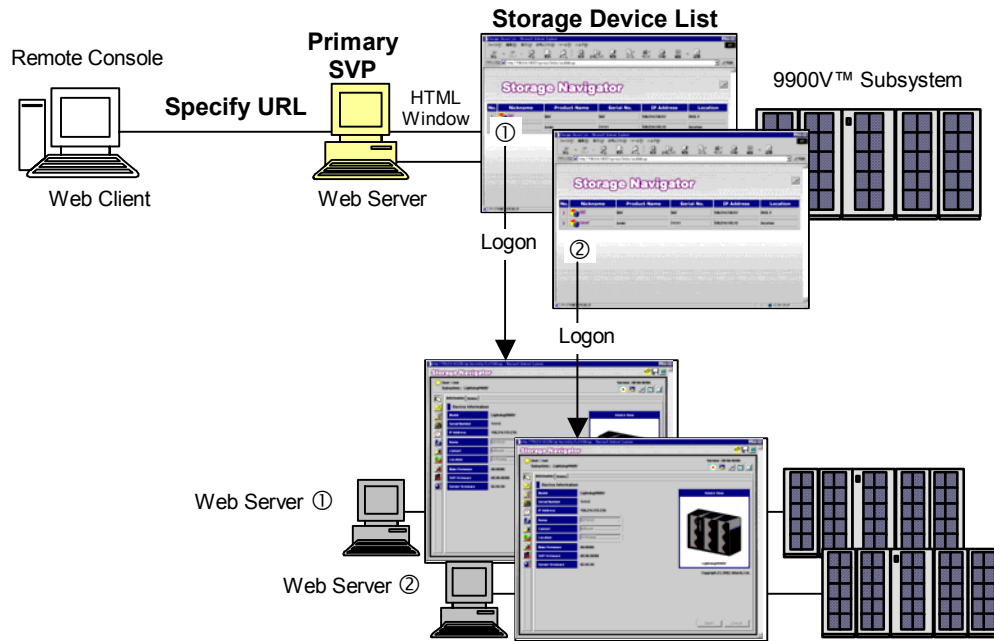

Figure 2.1 Selecting the Desired SVP (Web Server) From the Storage Device List

**Table 2.2 Specifications and Restrictions Concerning Logon Operations**

Item	Specification
Maximum number of concurrent users	The 9900V can support up to 32 concurrent users, but only one user can be in <b>Modify</b> mode at a time.
Logging on to multiple Web Servers (SVPs)	The same user can concurrently log on to more than one web server, by opening an individual storage device list for each SVP, downloading the web client Java™ applet program from each SVP, and executing the Java™ applets on separate web browser windows. <b>Note:</b> If you execute multiple web client Java™ applet programs for multiple SVPs, insufficient memory may degrade performance.
Logging on to the same Web Server more than once concurrently	The same user (ID) may not have multiple concurrent sessions with the same Web Server (SVP).
Logon history	All logon information, including user ID, logon and logoff time, is recorded in the logon history, which can be viewed by the Remote Console administrator.
Automatic logoff operation	If the user cannot perform Remote Console operations for a specific period of time because of a network error, the user will be automatically logged off from the SVP. The default is one minute, but the Remote Console administrator can specify a different amount of time.

**Note:** You must add the desired subsystems to the storage device list on the primary SVP (web server), before logging on to any SVP. For instructions on editing the storage device list, see section 3.2.

To log onto a subsystem:

1. Log onto the Remote Console and start your web browser.
2. To open the Storage Device List panel (see Figure 2.2), specify the URL of the primary SVP (where xxx.xxx.xxx.xxx is the IP address of the primary SVP) as follows:  
`http://xxx.xxx.xxx.xxx/cgi-bin/utility/sjc0000.cgi`
3. Select the hyperlink (either from the **No.** column or the **Nickname** column) of the desired SVP.
4. The Logon panel appears (see Figure 2.3).
5. Enter the user ID and password. **Note:** The default user ID is **root**. The default user password is **root**. Both are case sensitive.
6. Select the **OK** button.
7. If you successfully log on to the primary SVP, the Remote Console Main panel opens (see Figure 3.1).

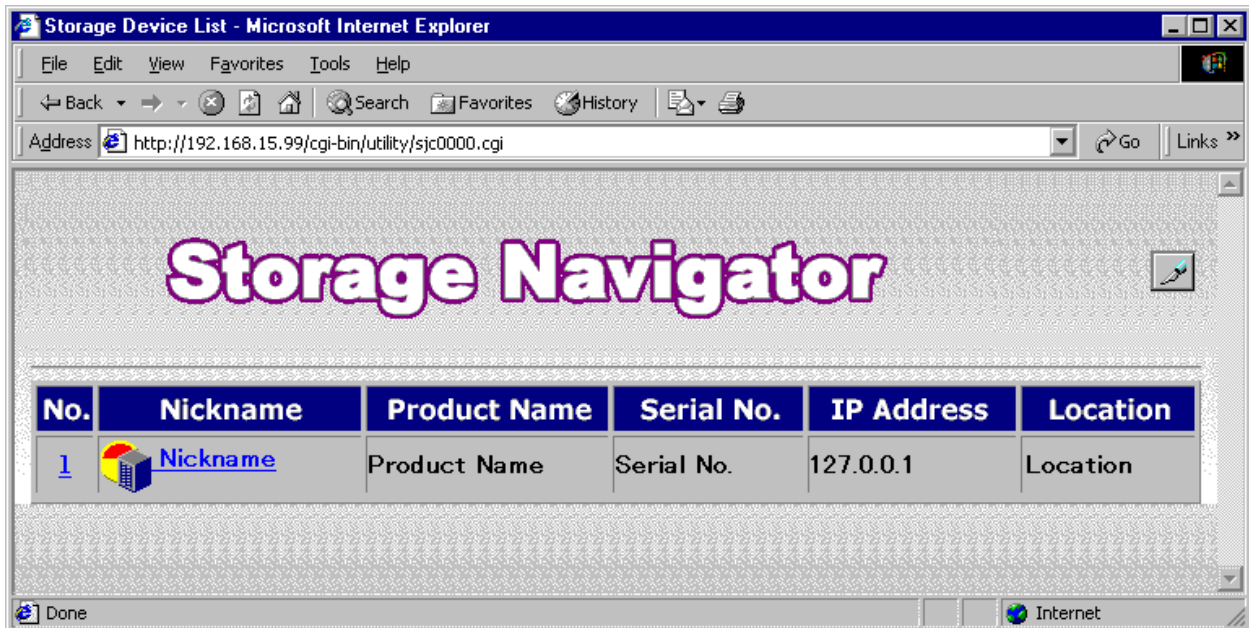

Figure 2.2 Storage Device List Panel

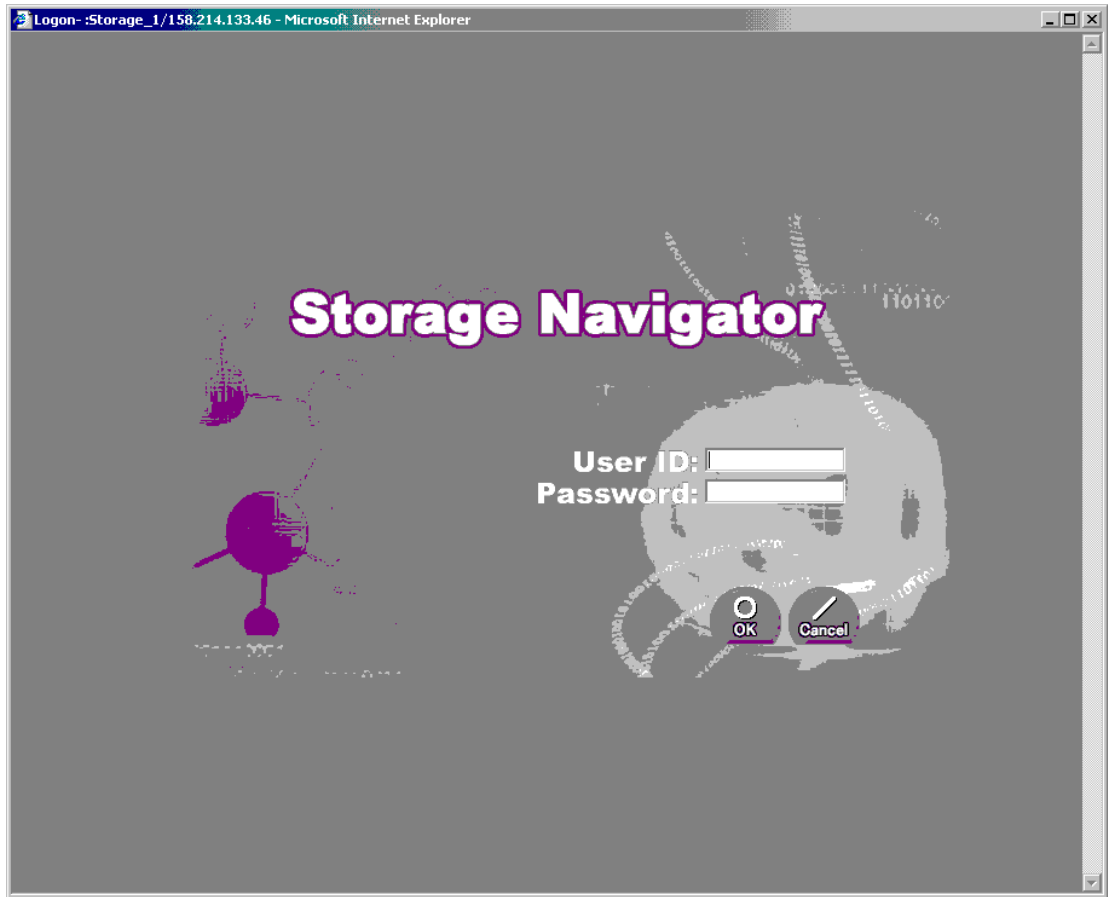

Figure 2.3 Logon Panel

## 2.5 Changing Between View Mode and Modify Mode

To change between View mode and Modify mode:







1. You must have administrator or write access for the option that you want to use.
2. Verify that the subsystem is unlocked. If all users are operating in **View** mode, the **Unlocked** icon () and the **View Mode** icon () are displayed (see Figure 2.4). If a user is operating in **Modify** mode, or if subsystem maintenance is being performed, the **Locked** icon () is displayed, and you will not be able to implement changes.
3. Select the **Mode Changing** icon, which should be in **View** mode (). Click on the icon, and a confirmation message will display (see Figure 2.5). Select **OK**.
4. Once you are in **Modify** mode, the **Mode Changing** icon will change from a gray background to a yellow background (), and the **Locked** icon () is displayed (see Figure 2.6).
5. Once you have applied your desired changes, you need to change back to **View** mode. Select the **Mode Changing** icon (). The confirmation message will display (see Figure 2.5). Select **OK**, and you will be back in **View** mode.





Figure 2.4 View Mode



Figure 2.5 Mode Changing Confirmation Message

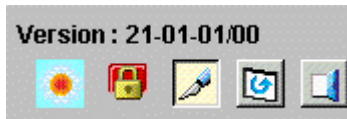

Figure 2.6 Modify Mode

## 2.6 License Keys

A license key is a textual key that functions as a password, because it is entered into Remote Console and unlocks the protection of an option. Because each license key is generated with a subsystem serial number and option ID input, each subsystem requires a unique license key code. License key codes for each option (including the Java™ applet) and subsystem are provided at the time of purchase.

(1) Installing an Individual Option Using the License Key Code.

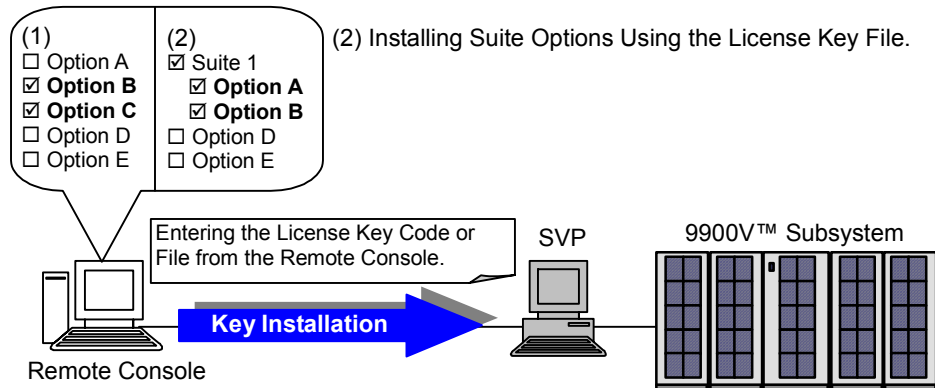

Figure 2.7 Overview of License Keys and Option Installation

There are three types of license keys: a temporary key, a permanent key, and an emergency key. A temporary key is for trial use. 75 days after the temporary license key is installed (or when there are 45 days left before the expiration), a warning message is displayed on the Remote Console Main panel when you either start the Remote Console or connect to a controller with the temporary license key. After 120 days, the temporary license key expires. A message that warns the user of the expiration of the license key is displayed, and the license key expiration is also reported to the host.

For Hitachi TrueCopy - S/390®, Hitachi TrueCopy, ShadowImage, and LUN Manager, the expiration of a temporary license key will have the following effects:

- No new configuration settings may be performed.
- The configuration settings that were made before the temporary license key expired remain in effect and cannot be deleted.

**Note:** Non-configuration settings that were made before the temporary license key expired can be deleted from the SVP only (not from the Remote Console).

For Virtual LVI/LUN, LUN Expansion, FlashAccess, and Hitachi Parallel Access Volume, the expiration of a temporary license key will have the following effects:

- No new configuration settings may be performed.
- The configuration settings that were made before the temporary license key expired remain in effect and cannot be deleted.

For Priority Access, the expiration of a temporary license key will have the following effects:

- No monitoring functions may be performed.
- No new configuration settings (e.g., upper-limit control, threshold control, or selection of port type) may be performed.

**Note:** Configuration settings that were made before the temporary license key expired may be expunged from the SVP only (not from the Remote Console). Contact your Hitachi Data Systems service representative (see section 5.2).

An emergency license key is used in situations where the temporary key is set to expire in the near future and the user cannot get the permanent key in time because of special circumstances (e.g., a licensed server has crashed or there are problems with the communication infrastructure). An emergency key may also be used when a user who does not intend to purchase the option needs to undo a configuration change that was made during the lifetime of the temporary license key. An emergency key is effective for 10 days.

**Note:** If you forcibly install an emergency key to an option that has already the permanent key, the license of that option will expire in 10 days.

## 2.7 Enabling and Disabling Options on the Remote Console

### 2.7.1 Remote Console Options

Table 2.3 lists the options for the 9900V Remote Console.

**Table 2.3 Remote Console Options**

Option Name	Notes
Hitachi TrueCopy – S/390® Hitachi TrueCopy – S/390® Asynchronous	Hitachi TrueCopy – S/390® Asynchronous requires Hitachi TrueCopy – S/390®
Hitachi Extended Remote Copy	For controller emulation type 2105 only.
Hitachi TrueCopy Hitachi TrueCopy Asynchronous	Hitachi TrueCopy Asynchronous requires Hitachi TrueCopy.
Hitachi ShadowImage – S/390® Hitachi ShadowImage	
Virtual LVI Virtual LUN	
LUN Expansion	Open systems only
LUN Manager	Open systems only.
Performance Monitor Hitachi CruiseControl™ Priority Access	Hitachi CruiseControl™ and Priority Access require Performance Monitor.
FlashAccess – S/390® FlashAccess	
Hitachi Parallel Access Volume	
Remote Console Software	Java™ applet programs that are downloaded from the SVP to the Remote Console.
Hitachi Multiplatform Backup/Restore	

**Note:** Contact your Hitachi Data Systems account team for the latest information on 9900V features and options.

The license for the Remote Console software options is verified when you log on to the SVP. If you are not licensed to use a particular option, the icon for that option will be grayed out.

## 2.7.2 License Key/SNMP/Just in Time Panel, License Key Tab

The **License Key** tab of the **License Key/SNMP/Just in Time** panel allows you to install and uninstall 9900V options for the connected subsystem. The **License Key** tab displays a list of 9900V options and allows you to enter the license key code for a desired option. To open the **License Key** tab, log onto the Remote Console, and from the Remote Console Main panel (see Figure 3.1) select the **License Key/SNMP/Just in Time** icon (  ), which is on the left side of the panel. The **License Key** tab is the default view. **Note:** If no Remote Console options have been installed, this panel opens automatically when you log on to the SVP.

The option icons (on the left side of the panel; see Figure 3.2) and subsystem information icons (on the top right corner of the panel; see Figure 3.3) are the same for all of the Remote Console panels. See section 3.1.1 for details on these icons.

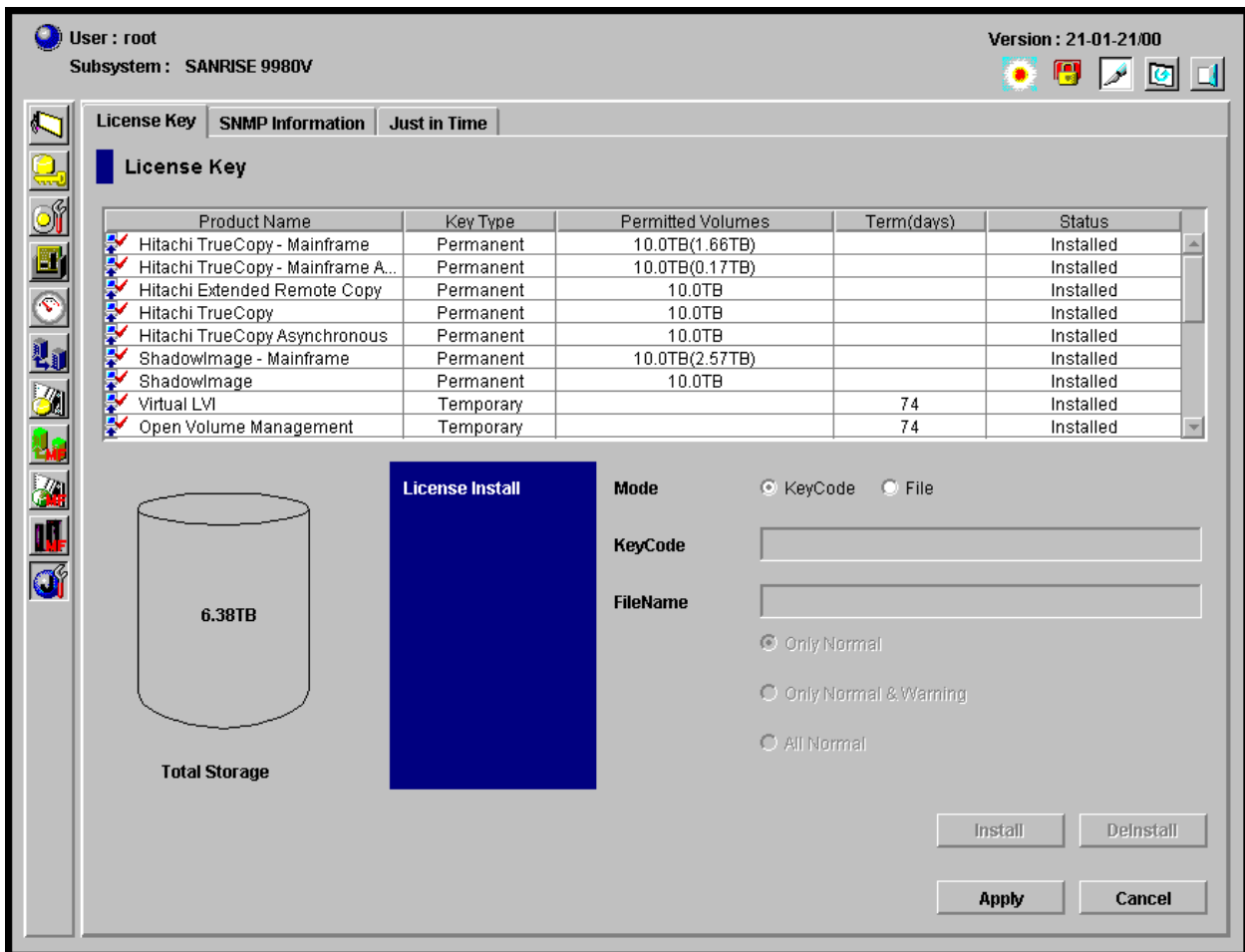









The screenshot displays the 'License Key' tab of the 'License Key/SNMP/Just in Time' panel. At the top, it shows 'User: root' and 'Subsystem: SANRISE 9980V'. The version is '21-01-21/00'. The panel has three tabs: 'License Key', 'SNMP Information', and 'Just in Time'. The 'License Key' tab is active, showing a table of installed license keys.

Product Name	Key Type	Permitted Volumes	Term(days)	Status
Hitachi TrueCopy - Mainframe	Permanent	10.0TB(1.66TB)		Installed
Hitachi TrueCopy - Mainframe A...	Permanent	10.0TB(0.17TB)		Installed
Hitachi Extended Remote Copy	Permanent	10.0TB		Installed
Hitachi TrueCopy	Permanent	10.0TB		Installed
Hitachi TrueCopy Asynchronous	Permanent	10.0TB		Installed
ShadowImage - Mainframe	Permanent	10.0TB(2.57TB)		Installed
ShadowImage	Permanent	10.0TB		Installed
Virtual LVI	Temporary		74	Installed
Open Volume Management	Temporary		74	Installed

Below the table, there is a 'License Install' dialog box. On the left, a cylinder icon represents 'Total Storage' with a value of '6.38TB'. On the right, there are fields for 'Mode' (radio buttons for 'KeyCode' and 'File'), 'KeyCode', and 'FileName'. Below these are three radio button options: 'Only Normal' (selected), 'Only Normal & Warning', and 'All Normal'. At the bottom right, there are four buttons: 'Install', 'Deinstall', 'Apply', and 'Cancel'.









Figure 2.8 License Key/SNMP/Just in Time Panel, License Key Tab

The **License Key** table is across the top of the **License Key** tab.

Product Name	Key Type	Permitted Volumes	Term(days)	Status
 Hitachi TrueCopy - S/390(R)				Not Installed
 Hitachi TrueCopy - S/390(R) Asy...				Not Installed
 Hitachi Extended Remote Copy				Not Installed
 Hitachi TrueCopy	Temporary		87	Installed
 Hitachi TrueCopy Asynchronous	Temporary		87	Installed
 ShadowImage - S/390(R)				Not Installed
 ShadowImage				Not Installed
 Virtual LVI				Not Installed
 Open Volume Management	Temporary		87	Installed

**Figure 2.9 License Key Table (From the License Key/SNMP/Just in Time Panel, License Key Tab)**

The **License Key** table has the following features:

- The **Product Name** column includes:
  - The option name,
  - An icon that indicates whether the option is available ( indicates **Installed**;  indicates **Not Installed**),
  - An icon that indicates whether the option is set to install or deinstall ( indicates **Install Set**,  indicates **Deinstall Set**).
- The **Key Type** column shows the license type: **Permanent**, **Temporary** or **Emergency**.
- The **Permitted Volumes** column shows:
  - The available capacity (licensed capacity),
  - The capacity that is already being used by the Hitachi TrueCopy, Hitachi Extended Remote Copy, and ShadowImage options, which is displayed as **Used Volume**. **Note:** If the size is unlimited, **Unlimited** is displayed.
- The **Term (days)** column shows the number of days that remain before the expiration of a temporary or emergency key. If the temporary or emergency key is no longer valid, the number of days that have elapsed since the expiration of the license key will be displayed with a minus sign (-).
- The **Status** column shows the current status of an option:
  - **Installed:** The option is available. The **Product Name** column will display the **Installed** icon (.
  - **Not Installed:** The option is not available. The **Product Name** column will display the **Not Installed** icon (.
  - **Not Enough:** The volume capacity is insufficient. The **Product Name** column will display the **Installed** icon (.
  - **Time Out:** The term has already expired for the temporary key. The **Product Name** column will display the **Not Installed** icon (.
  - **Reinstall Key:** The option is not installed. The **Product Name** column will display the **Not Installed** icon (.

The **Total Storage** graphic is on the lower left corner of the **License Key** tab, and displays the total volume capacity currently available in the 9900V subsystem.

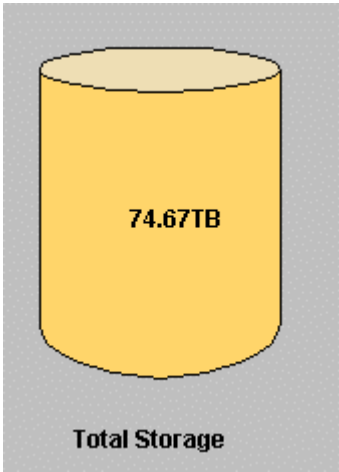
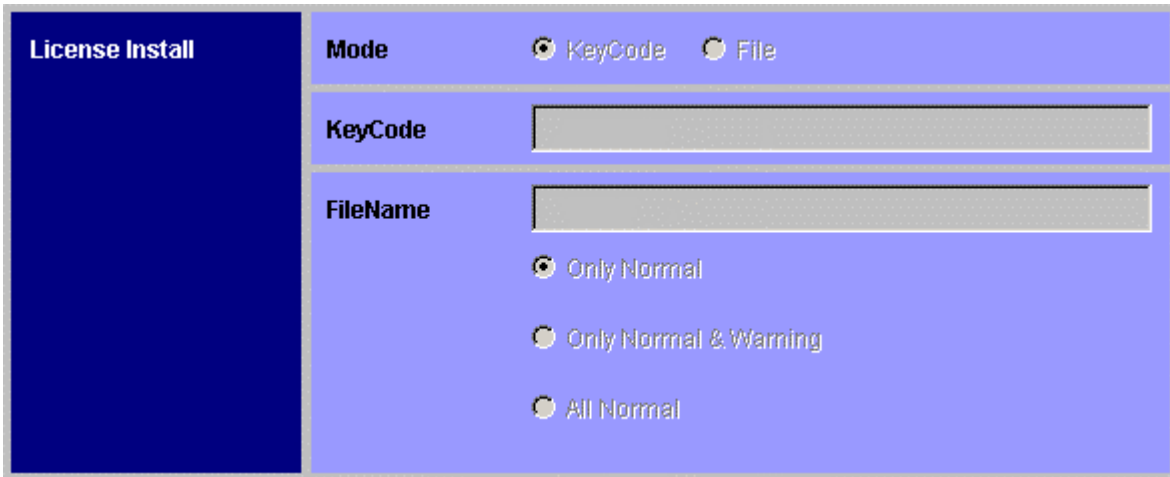

Figure 2.10 Total Storage Graphic (From the License Key/SNMP/Just in Time Panel, License Key Tab)

The **License Install** box is on the right side of the **License Key** tab.

The image shows a software interface for license installation. On the left is a dark blue vertical bar with the text "License Install" in white. To the right is a light blue panel. At the top of this panel is a "Mode" section with two radio buttons: "KeyCode" (which is selected) and "File". Below this are two text input fields: "KeyCode" and "FileName". At the bottom of the panel are three radio buttons: "Only Normal" (selected), "Only Normal & Warning", and "All Normal".

**Figure 2.11** License Install Box (From the License Key/SNMP/Just in Time Panel, License Key Tab)

- The **Mode** box allows you to select either the **Key Code** button or the **File** button.
  - The **Key Code** button enables the **Key Code** text box, which allows you to enter the license key for the selected option to be installed (see section 2.7.3). **Note:** You cannot copy and paste text from other applications.
  - The **File** button enables the **File Name** text box, which allows you to enter the name of the desired license key file (see section 2.7.4). **Note:** The license key file must be uploaded to the SVP. For instructions on uploading the license key file, see section 3.12.

The radio buttons on the lower right of the **License Install** box affect the display of the options in the **License Key** table (refer to Figure 2.9) as follows:

- The **Only Normal** button will display only successfully installed options. This is the default.
- The **Only Normal & Warning** button will display both successfully installed options and the following failed options:
  - If you are installing an emergency key for the option that has already been installed with a permanent key, or
  - If the licensed capacity is insufficient.
- The **All Normal** button displays options only if all options have been successfully installed. If installation of any of the options failed, no option will be displayed.



The buttons on the lower right of the **License Key** tab set up the options to be installed.

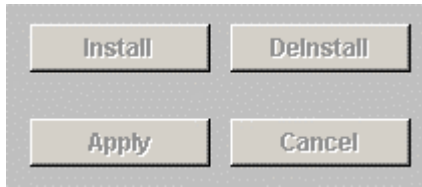











**Figure 2.12** Install, Deinstall, Apply and Cancel Buttons (From the License Key/SNMP/Just in Time Panel, License Key Tab)

- The **Install** button changes the icon of the selected option from **Not Installed** (🔌) to **Installed** (🔌✓). **Note:** the options are not actually installed until you select the **Apply** button.
- The **Deinstall** button changes the icon of the selected option from **Installed** (🔌✓) to **Not Installed** (🔌). **Note:** the options are not actually deinstalled until you select the **Apply** button.
- The **Apply** button implements the settings made using the **Install** or **Deinstall** buttons to the subsystem. The status of installed options changes to **Installed**, and the status of deinstalled option changes to **Not Installed**.
- The **Cancel** button cancels the settings made using the **Install** or **Deinstall** buttons.

Table 2.4 explains the icons shown on the **License Key** tab.

**Table 2.4 License Key Status Icon**

License Key Status	License Key Panel Display					
	Icon	Product Name (Note 1)	Key Type	Permitted Volume	Term (days)	Status
Not installed.	 : (Not Installed).	Option name	–	–	–	Not Installed
A <b>Temporary</b> key was installed, but has expired.	 : (Not Installed).	Option name	–	–	(Note 2)	Time Out
Installed with the <b>Permanent</b> key, but the license capacity was insufficient.	 : (Not Installed).	Option name	–	<b>X.X</b> TB (Note 3)	–	Not Enough
First installed with the <b>Permanent</b> key, and then reinstalled with the <b>Emergency</b> key and the term expired.	 : (Not Installed).	Option name	–	<b>X.X</b> TB (Note 3)	–	
Installed with the unlimited <b>Permanent</b> key.	 : (Installed)	Option name	Permanent	Unlimited	–	Installed
Installed with the limited <b>Permanent</b> key.	 : (Installed)	Option name	Permanent	<b>X.X</b> TB (Note 3)	–	Installed
Installed with the <b>Permanent</b> key	 : (Installed)	Option name	Emergency	Unlimited	(Note 2)	Installed
Installed with the <b>Permanent</b> key, then reinstalled with the <b>Emergency</b> key.	 : (Installed)	Option name	Emergency	<b>X.X</b> TB (Note 3)	(Note 2)	Installed
Installed with <b>Emergency</b> key.	 : (Installed)	Option name	Emergency	–	(Note 2)	Installed
Installed with <b>Temporary</b> key.	 : (Installed)	Option name	Temporary	–	(Note 2)	Installed
1. Installed with the <b>Temporary</b> key, and then reinstalled with the <b>Permanent</b> key, but the license capacity was insufficient, or 2. Installed with the <b>Permanent</b> key and then reinstalled with the <b>Temporary</b> key although the license capacity was insufficient.	 : (Installed)	Option name	Temporary	<b>X.X</b> TB (Note 3)	(Note 2)	Installed

**Note 1:** See Table 2.3 for option names.

**Note 2:** *N* indicates the number of days remained before the expiration. If the key is no longer valid, the number of days that have elapsed after the expiration is displayed with a minus sign (-).

**Note 3:** For Hitachi TrueCopy, Hitachi Extended Remote Copy, and ShadowImage options, “**X.X** TB (**X.XX** TB)” is displayed. *X* indicates the capacity.

### 2.7.3 Enabling a Remote Console Option Using a License Key Code

To enable a 9900V Remote Console option by using the license key code:



1. Change to **Modify** mode (refer to section 2.5 if you need instructions).
2. Select the **License Key/SNMP/Just in Time** button () on the Remote Console Main panel to open the License Key/SNMP/Just in Time panel (refer to Figure 2.8). The **License Key** tab is the default view. **Note:** If no Remote Console options have been installed, this panel opens automatically when you log on to the SVP.
3. Select **Key Code** in the **Mode** box.
4. Select the desired option that you want to install in the list. **Note:** You can only select one option at a time using this method. To install multiple options at a time, see section 2.7.4. The line of the selected option is displayed in reverse video.
5. In the **Key Code** box, enter the license key code. **Note:** You cannot copy and paste text from other applications. To enable one or more Remote Console options using a license key file, see section 2.7.3.
6. Select the **Install** button.
7. A confirmation message will display. Select **OK** to continue installing the option, or select **Cancel** to cancel the setting. The **Not Installed** icon () will change to **Installed** (). **Important:** To implement the setting, you must select the **Apply** button (see below).
8. You will see a warning message in the following cases.
  - If you are installing an emergency key for the option that has already been installed with a permanent key. If you install the emergency key, it will expire in 10 days.
  - If you are attempting to install an emergency key when the remaining lifetime of the option is more than 10 days. You cannot install an emergency key under these circumstances.
9. If you want to apply the changes to the subsystem, select **Apply** and then select **OK** on the confirmation message (see Figure 2.13).
10. If you want to cancel the changes and not apply them to the subsystem, select **Cancel** and then select **OK** on the confirmation message (see Figure 2.14).



Figure 2.13 Apply Confirmation Message

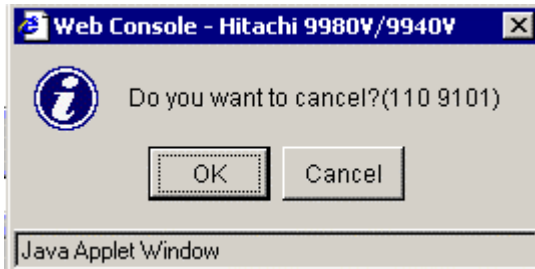



Figure 2.14 Cancel Confirmation Message.

## 2.7.4 Enabling Remote Console Options Using a License Key File

You can also enable multiple options in a single procedure, using a license key file. The license key files are provided by Hitachi Data Systems. You must upload the desired license key file to the SVP before using the license key file to enable options on the Remote Console (see section 3.12 for instructions).



To install Remote Console options on the Remote Console using the license key file:

1. Log on to the SVP to open the Remote Console Main panel (see Figure 3.1).
2. Select the **License Key/SNMP/Just in Time** button () on the Remote Console Main panel to open the License Key/SNMP/Just in Time panel (refer to Figure 2.8). The **License Key** tab is the default view. **Note:** If no Remote Console options have been installed, this panel opens automatically when you log on to the SVP.
3. From the **Mode** box, select **File**.
4. In the **File Name** box, enter the name of the license key file that you previously uploaded to the SVP. **Note:** For the file name, you can enter up to 200 alphanumeric characters (ASCII codes) except for the following symbols:  
", \, /, :, \*, ?, <, >, |, /.
5. Select the registration mode (**Only Normal**, **Only Normal & Warning**, or **All Normal**).
6. A confirmation message will display. Select **OK**. **Important:** To implement the setting, you must select the **Apply** button (see below).
7. If you want to apply the changes to the subsystem, select **Apply** and then select **OK** on the confirmation message (refer to Figure 2.13).
8. If you want to cancel the changes and not apply them to the subsystem, select **Cancel** and then select **OK** on the confirmation message (refer to Figure 2.14).

**Note:** If installation fails or an error occurs during the installation, a message panel appears and lists the failed options. To display the cause of failure or error, select the failed option and select the **Detail** button.

## 2.7.5 Disabling Remote Console Options

To disable a Remote Console option:

1. Log on to the SVP to open the Remote Console Main panel (see Figure 3.1).
2. Select the **License Key/SNMP/Just in Time** button () on the Remote Console Main panel. The **License Key** tab is the default view.
3. Select the desired option that you want to deinstall in the list. The selected option is displayed in reverse video. Select the **Deinstall** button. A confirmation message will display.
4. Select **OK** to continue installing the option, or select **Cancel** to cancel the setting. The **Installed** icon () will change to **Not Installed** (). **Important:** To implement the setting, you must select the **Apply** button (see below).
5. If you want to apply the changes to the subsystem, select **Apply** and then select **OK** on the confirmation message (refer to Figure 2.13).
6. If you want to cancel the changes and not apply them to the subsystem, select **Cancel** and then select **OK** on the confirmation message (refer to Figure 2.14).

## Chapter 3 Lightning 9900™ V Series Remote Console Operations

You can perform the following types of operations on the 9900V Remote Console:

- Using the Remote Console Main panel, Information tab (see section 3.1.1),
- Using the Remote Console Main panel, Status tab (see section 3.1.2),
- Launching the desired option (see section 3.1.3),
- Editing the storage device list (see section 3.2),
- Editing the user account list (see section 3.3),
- Setting Remote Console environment parameters (see section 3.4),
- Viewing the Remote Console log information (see section 3.5),
- Downloading the log and configuration files (see section 3.6),
- Restoring the storage device list, the user account list and the environment parameters (administrator only) (see section 3.7),
- Viewing the Remote Console information and changing the password (see section 3.8),
- Extending cache memory and LUNs (see section 3.9),
- Downloading Remote Console trace files using FD Dump Tool (see section 3.10),
- Exporting data to files using the Export File function (see section 3.11),
- Uploading files to the SVP using the FTP Client function (see section 3.12).

### 3.1 The Remote Console Main Panel

#### 3.1.1 Remote Console Main Panel, Information Tab

The Remote Console Main panel (see Figure 3.1) opens automatically after a user logs on to the SVP. The **Information** tab is the default view. **Note:** Until you have installed one or more Remote Console options, the License Key/SNMP/Just in Time panel will open first (refer to Figure 2.8). Once you have installed one or more options, the Remote Console Main panel (see Figure 3.1) opens when you log on to the SVP.

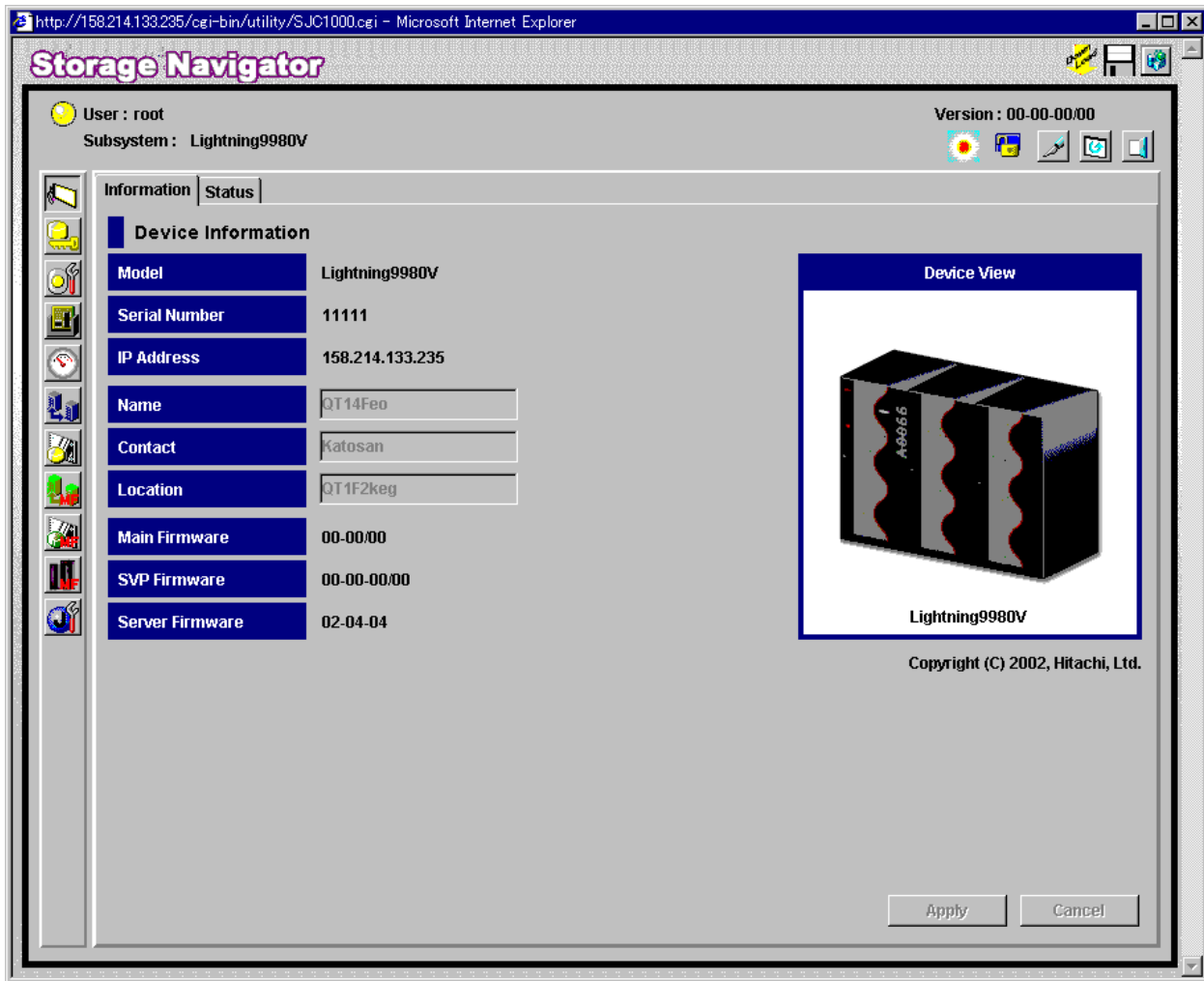
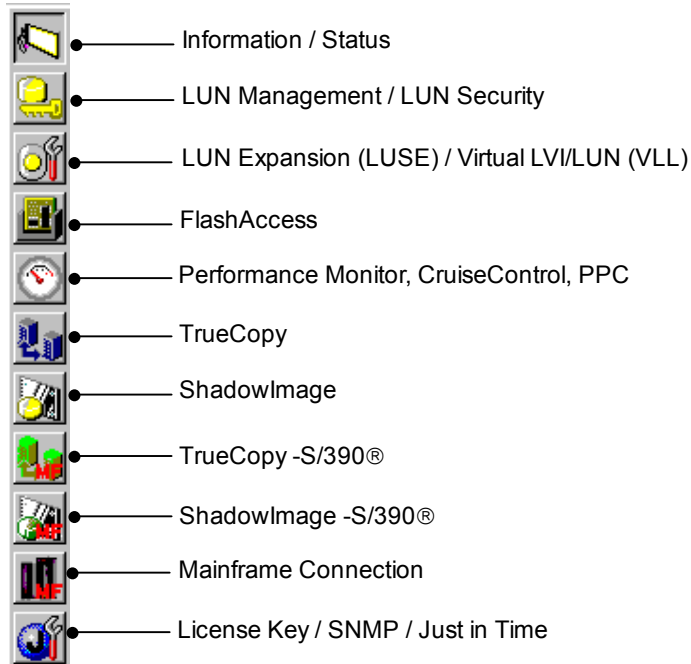













Figure 3.1 Remote Console Main Panel, Information Tab



The **Option** buttons are displayed vertically on the left of the Remote Console Main panel. They also appear on the left side of all of the Remote Console panels, for ease of navigation. Each button launches the corresponding option. If you float your cursor over a particular icon, the name of the corresponding option(s) will display. Figure 3.2 defines the icons.



**Figure 3.2 Option Buttons (From the Remote Console Main Panel, Information Tab)**

- The **Information/Status** button () returns you to the Remote Console Main panel.
- The **LUN Manager/LUN Security** button () opens the LUN Manager/Port panel. See *Hitachi Freedom Storage™ Lightning 9900™ V Series LUN Manager User's Guide* (MK-92RD105) for more information on LUN Manager.
- The **LUN Expansion (LUSE)/Virtual LVI/LUN (VLL)** button () opens the LUSE/VLL panel. See *Hitachi Freedom Storage™ Lightning 9900™ V Series LUN Expansion (LUSE)/Virtual LVI/LUN (VLL) User's Guide* (MK-92RD104) for more information on LUN Expansion or Virtual LVI/LUN.
- The **FlashAccess** button () opens the FlashAccess panel. See *Hitachi Freedom Storage™ Lightning 9900™ V Series FlashAccess User's Guide* (MK-92RD102) for more information on FlashAccess.
- The **Performance Monitor/CruiseControl/PPC** button () opens the Performance Monitor/Monitoring Options panel. See *Hitachi Freedom Storage™ Lightning 9900™ V Series Performance Monitor User's Guide* (MK-92RD133), *Hitachi Freedom Storage™ Lightning 9900™ V Series CruiseControl User's Guide* (MK-92RD106), and *Hitachi Freedom Storage™ Lightning 9900™ V Series Priority Access User's Guide* (MK-92RD117) for more information on these program products.
- The **TrueCopy** button () opens the Pair Operations/RCU Operations/Asynchronous Operations/Usage Monitor panel. See *Hitachi Freedom Storage™ Lightning 9900™ V Series TrueCopy User's Guide* (MK-92RD108) for more information on TrueCopy.
- The **ShadowImage** button () opens the Main/History/Options panel. See *Hitachi Freedom Storage™ Lightning 9900™ V Series ShadowImage User's Guide* (MK-92RD110) for more information on ShadowImage.
- The **TrueCopy - S/390®** button () opens the Pair Operations/RCU Operations/Asynchronous Operations/Usage Monitor panel. See *Hitachi Freedom Storage™ Lightning 9900™ V Series TrueCopy - S/390® User's Guide* (MK-92RD107) for more information on TrueCopy - S/390®.
- The **ShadowImage - S/390®** button () opens the Main/History/Options panel. See *Hitachi Freedom Storage™ Lightning 9900™ V Series ShadowImage - S/390® User's Guide* (MK-92RD109) for more information on ShadowImage - S/390®.
- The **Mainframe Connection** button () opens the HPAV panel. See *Hitachi Freedom Storage™ Lightning 9900™ V Series Parallel Access Volume User's Guide* (MK-92RD118) for more information on ShadowImage.
- The **License Key/SNMP/Just in Time** button () opens the License Key/SNMP/Just in Time panel. For more information on using license keys, see sections 2.5 through 2.7. For more information on using SNMP, see Chapter 4. For more information on using the Just in Time functions, see section 3.9.

The subsystem information icons are across the top of the Remote Console Main panel, as well as all of the option panels. **Note:** The information might not be displayed correctly when the exclusive lock is effective or SVP maintenance is in progress or if SNMP operations are being performed.

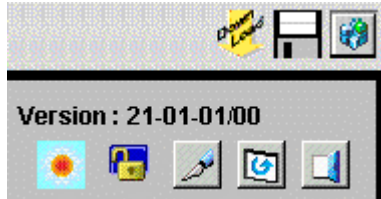

**Figure 3.3 Subsystem Information Icons (From the Remote Console Main Panel, Information Tab)**

- The **FTP Client** button (📁) opens the File Download panel (see Figure 3.28). You can upload files from the Remote Console to the SVP using the FTP Client function. The FTP Client function is required when you use the license key file for installing multiple options. See section 3.12 for the FTP Client function.
- The **Export** button (📁) opens the Export Data File panel (see Figure 3.48). You can export data (for example, monitoring data used by certain options such as Performance Monitor and Hitachi TrueCopy) to files using the Export File function. See section 3.10 for details on the Export File function.
- The **Option** button (🌐) opens the Control Panel (see Figure 3.17). If you are logged in as an administrator. If you are logged in as an ordinary user, it opens the User Control Panel (see Figure 3.36).
- The **Version** entry shows the version of web client Java™ applet program downloaded from the connected SVP (Web server). The Java™ applet program is downloaded at each time the Remote Console connects to the SVP, so that the version is always consistent between the Remote Console and SVP.
- The **Wait Status** icon alternates between **Status** (☀️) and **Wait** (🌙), either after **Refresh** button is selected, or while the subsystem is updating the information displayed on the panel displayed.
- The exclusive lock icons indicate the operation mode of all currently logged-in users. If all users are operating in **View** mode, the **Unlocked** icon (🔓) is displayed. If a user is operating in the **Modify** mode, the **Locked** icon (🔒) is displayed. **Note:** The display may show as **Locked** (🔒) when the SVP maintenance is in progress or if SNMP operations are being performed.
- The **Mode-Switching** buttons allow users to switch the operation mode between **View** mode (🖱️) and **Modify** mode (🖋️). **Note:** Only one user at a time can be in **Modify** mode. Make sure that the subsystem is not locked before attempting to switch to **Modify** mode. If you select the **Mode-Switching** button a confirmation message will display.
- The **Refresh** button (🔄) displays the latest information on the Remote Console Main panel.

The **Exit** button (🚪) closes the Remote Console Main panel.

The **Device Information** box is on left side of the **Information** tab:



Device Information	
Device Information	SANRISE 9980V
Serial Number	11111
IP Address	158.214.135.87
Name	<input type="text" value="TestMachine"/>
Contact	<input type="text" value="5263"/>
Location	<input type="text" value="HSP1F"/>
Main Firmware	00-00:00
SVP Firmware	00-00-00:00
Server Firmware	02-01-22

Figure 3.4 Device Information Box (From the Remote Console Main Panel, Information Tab)

- **Device Information:** The product name of the connected subsystem.
- **Serial Number:** The serial number of the connected subsystem.
- **IP Address:** The IP address of the connected subsystem (SVP).
- **Name:** The device name of the connected subsystem. This can be changed if you are in **Modify** mode. You must enter a device name using up to 255 alphanumeric characters. **Note:** The device name is required to use SNMP Agent. Make sure to document the device name, because the settings will be cleared if the SVP is replaced.
- **Contact:** The contact information such as personnel and telephone number where you can inquire about the connected subsystem. The Remote Console user can change the contact information with the **Modify** mode. You must enter the contact information using up to 255 alphanumeric characters. **Note:** The contact name is required to use SNMP Agent. Make sure to document the contact name, because the settings will be cleared if the SVP is replaced.
- **Device Location:** The location of the connected subsystem. The Remote Console user can change the device location with the **Modify** mode. You must enter a device location using up to 255 alphanumeric characters. **Note:** The device location is required to use SNMP Agent. Make sure to document the device location, because the settings will be cleared if the SVP is replaced.
- **Main Firmware:** The version of the microcode installed in the connected subsystem.
- **SVP Firmware:** The version of the web client Java™ applet program installed in the SVP of the connected subsystem.
- **Server Firmware:** The version of the RMI™ server installed in the SVP of the connected subsystem.

The Device View, and the **Apply** and **Cancel** buttons are on the lower right of the Remote Console Main panel.

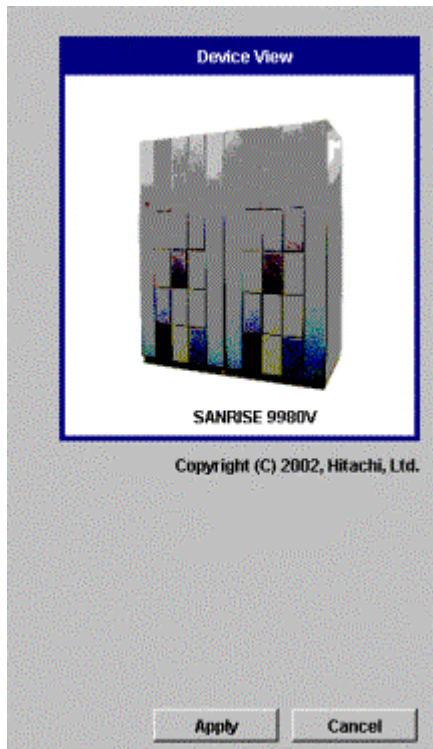

**Figure 3.5** Device View, Apply Button and Cancel Buttons (From the Remote Console Main Panel, Information Tab)

- **Device View:** This is the product name and a visual image (picture) of the connected subsystem.
- The **Apply** button implements all of the changes or settings made on the Remote Console Main panel.
- The **Cancel** button cancels the changes or settings made on the Remote Console Main panel.

**Note:** If you input any changes, the text color may change to blue or an icon may change. The changes are not actually implemented until you select the **Apply** button.

### 3.1.2 Remote Console Main Panel, Status Tab

The **Status** tab of the Remote Console Main panel shows detailed information on the internal status of the connected subsystem, including the service information message (SIM) information that is being reported to the host. There are five SIM severity levels: good, service, moderate, serious, and acute.

**Note:** The 9900V subsystem generates a SIM whenever it detects an error or service requirement. The status level displayed on the **Status** tab is based on the SIM information that is reported to the host. The SIM information that is not reported to the host is not displayed on the **Status** tab.



Figure 3.6 Remote Console Main Panel, Status Tab

The **Controller Status** box is on the upper left corner of the **Status** tab.

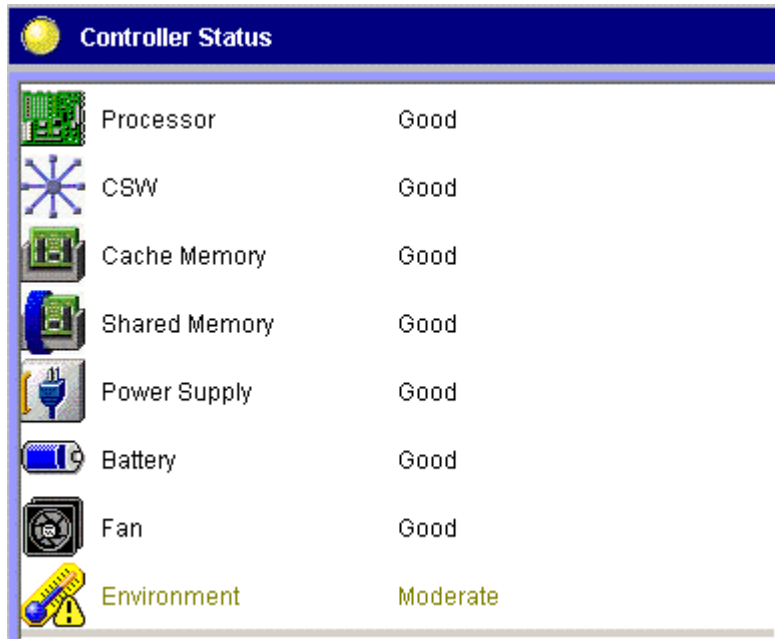

**Figure 3.7 Controller Status Box (From the Remote Console Main Panel, Status Tab)**

- The status lamp icons **Normal** (blue) **Warning** (yellow) or **Abnormal** (red) indicate the controller error status by color, according to the host SIM status. The status level displayed on the Status panel is based on the SIM information that is reported to the host. SIM information that is not reported to the host is not displayed.
- The **Controller Status** box shows the internal status levels of the following subsystem elements:
  - Processor
  - CSW (switch to control cache)
  - Shared memory
  - Power supply
  - Battery
  - Fan
  - Environment.

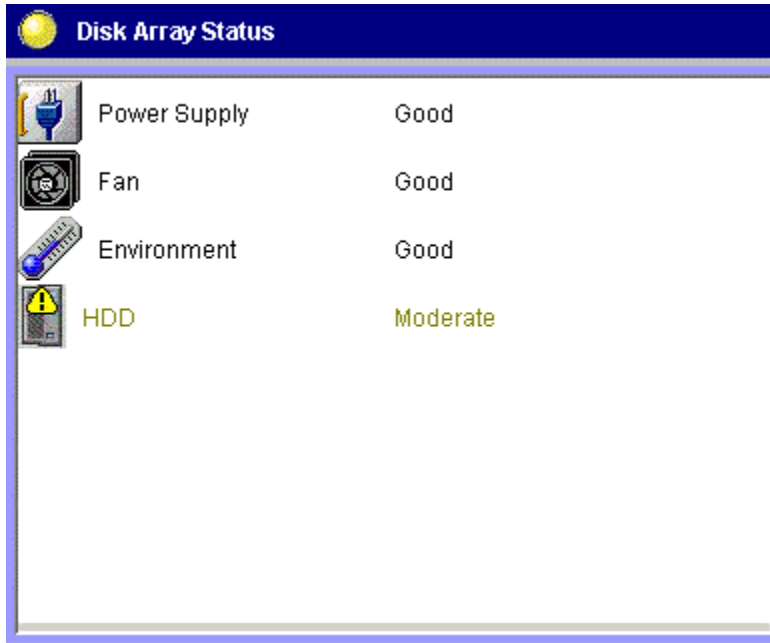

Figure 3.8 Disk Array Status Box (From the Remote Console Main Panel, Status Tab)

- The status lamp icons **Normal** (blue) **Warning** (yellow) or **Abnormal** (red) indicate the disk array error status by color, according to the host SIM status.
- The **Disk Array Status** box shows the internal status levels of the disk array unit (DKU) of the following items:
  - power supply
  - fan
  - environment
  - hard disk drives.

The **Status History** box is on the lower half of the **Status** tab, and displays the history of errors by reference code, error level, and date and time of error occurrence. **Note:** For information on SIM reference codes, refer to the troubleshooting section of the *Hitachi Freedom Storage Lightning 9900V User and Reference Guide (MK92-RD100)*, or contact the Hitachi Data Systems Support Center.

Status History		
Ref.Code	Error Level	Date
BF1211	Moderate	2002/04/14 13:09:03
BF1210	Moderate	2002/04/14 13:14:55
DF8C1C	Moderate	2002/04/14 16:00:08

Figure 3.9 Status History Box (From the Remote Console Main Panel, Status Tab)





Table 3.1 lists the environmental errors that can occur.

**Table 3.1 Disk Controller and Disk Array Unit Error Conditions**

Disk Controller Environment Error		Disk Array Unit Environment Error
Abnormal temperature	Environment monitor failure	Voltage alarm
Voltage alarm	Environment monitor unmatched	Voltage warning
Voltage warning	Keylock panel connection error	Forget-to-remove JP warning
AC warning	Keylock resistor error	Environment monitor failure
Forget-to-remove JP warning	Abnormal power supply in SVP	Environment monitor unmatched
DKCMAIN type unmatched		

Table 3.2 gives detailed information on the Service Information Message (SIM) severity levels and icons.

**Table 3.2 SIM Severity Levels and Icons**

No.	Severity Level	Color of Icon	Description
1	Good	 Blue	No error occurs and the status is good.
2	Service	 Yellow	Service and Moderate do not require immediate attention and are addressed during routine maintenance.
3	Moderate		
4	Serious	 Red	Contact the Hitachi Technical Support Center. Follow up with the Support Center to verify that the problem has been resolved (see section 5.2).
5	Acute		

**Note:** Once the status becomes other than **Good**, all SIMs must be completed (resolved) from the SVP to restore the status to **Good**. Contact your Hitachi Data Systems service representative for assistance.

### 3.1.3 Launching the Desired Option

To launch a particular option, select the appropriate icon from the left side of all of the Remote Console panels (refer to Figure 3.2). If you hold the mouse pointer over an icon, the option name will be displayed.

To return to the Remote Console Main panel, Information tab (refer to Figure 3.1), select the **Information / Status**  icon.

To exit the Remote Console Main panel, select the **Exit** button  from the upper right corner of the panel. The Remote Console automatically logs off from the connected SVP.

## 3.2 Editing the Storage Device List (Administrator Only)

The operations for editing a 9900V Remote Console storage device list include:

- Adding storage device entries (see section 3.2.2),
- Changing storage device entries (see section 3.2.3), and
- Deleting storage device entries (see section 3.2.4).

### 3.2.1 The Storage Device List Panels



Figure 3.10 Logon Panel

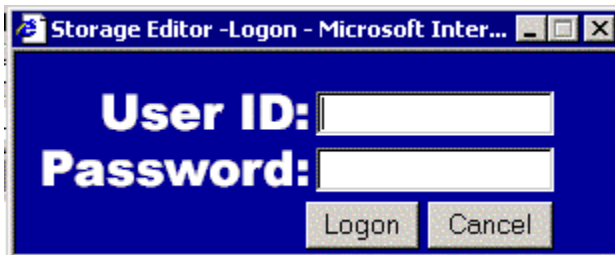

Figure 3.11 Storage Editor Logon Panel

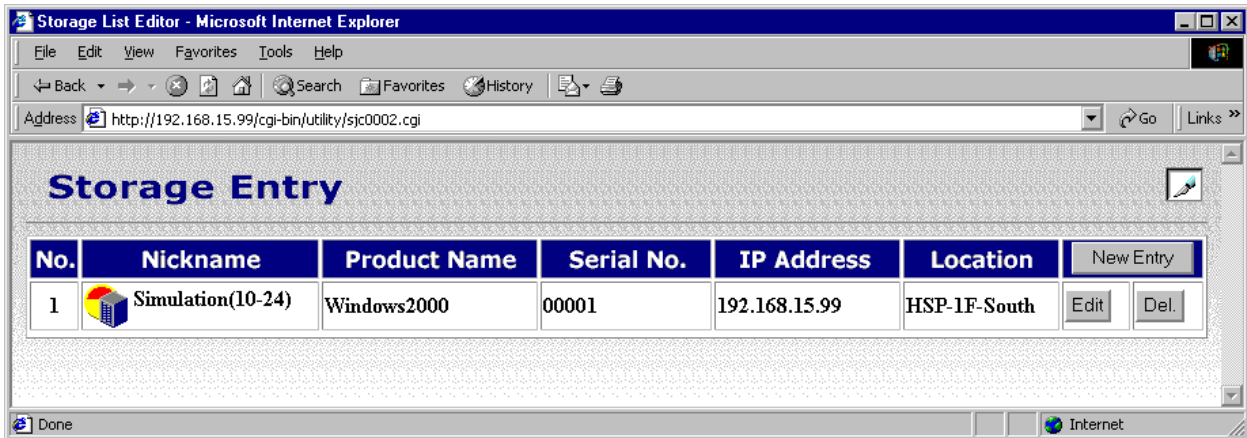



Figure 3.12 Storage Entry Panel



The Storage List Editor panel has the following features:

- The **Storage Device List** button (  ) returns you to the Storage Device List panel.
- The **New Entry** button opens the Storage Entry panel (see Figure 3.13), which allows you to add a new storage device entry. **Note:** You can register up to 500 storage device entries. You cannot concurrently access 500 storage devices.
- The **Edit** button opens the Change Storage Entry panel (see Figure 3.13), which allows you to change the storage device entry.

The **Del.** button deletes a storage device entry. **Note:** A confirmation message is displayed before a storage device entry is deleted.

## 3.2.2 Adding a Storage Device

To add a new 9900V storage device entry:

1. Either log in to the primary SVP, or log out of the Remote Console to access the Logon panel (refer to Figure 3.10).
2. Instead of clicking on a hyperlink to select a subsystem, select the **Mode Changing** icon, which should be in **View** mode (.
3. The Storage Editor - Logon panel (refer to Figure 3.11) will display. Enter your user name and password, and select **Logon** to open the Storage List Editor panel (refer to Figure 3.12). The Mode Changing icon will be in **Modify** mode (.
4. Select **New Entry** to open the Change Storage Entry panel (refer to Figure 3.13).
5. On the Change Storage Entry panel, fill the following information about the subsystem that you want to add (all fields are required):
  - The nickname and product name can be up to 16 alphanumeric characters
  - The serial number can be a number from 1 to 65535.
  - The IP address is the IP address of the SVP of the subsystem you are seeking to add.
  - The location can be up to 16 alphanumeric characters.
6. Select **Submit** to register the storage device entry. The Register Device Confirmation Message will display (see Figure 3.14).
7. Select **OK** to register, or select **Cancel** to cancel. When the entry is registered successfully, the Registration Complete confirmation message will display. (see Figure 3.15).
8. Select the **Close** button to return to the Storage Device List panel (refer to Figure 3.10). The new storage device entry is added to the end of the list.

**Caution:** If you edit the storage device list, you must back up the Web Console configuration file by downloading the file from the SVP. For instructions on downloading the configuration file, see section 3.6.

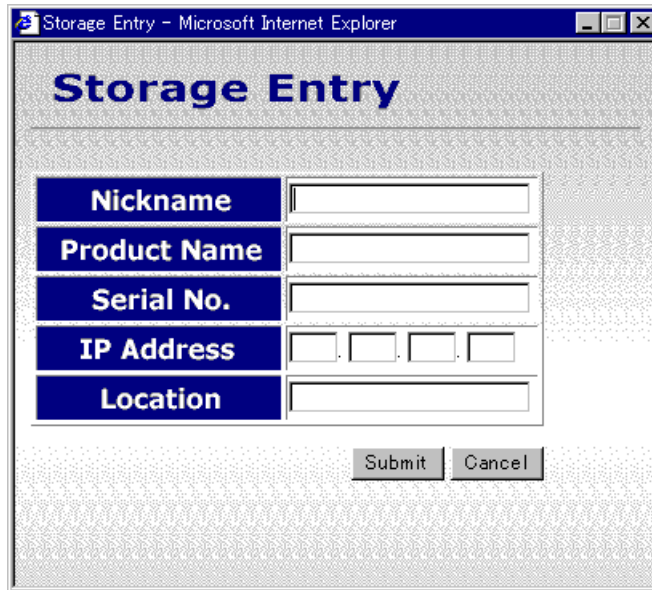

Figure 3.13 Change Storage Entry Panel

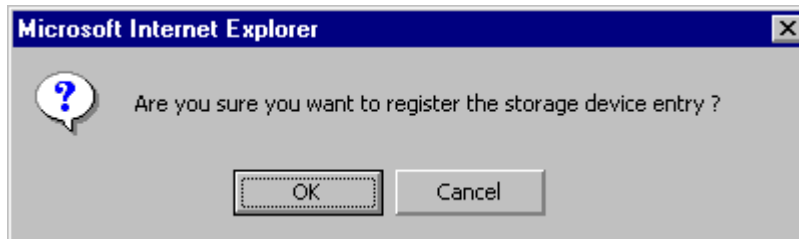

Figure 3.14 Register Device Confirmation Message

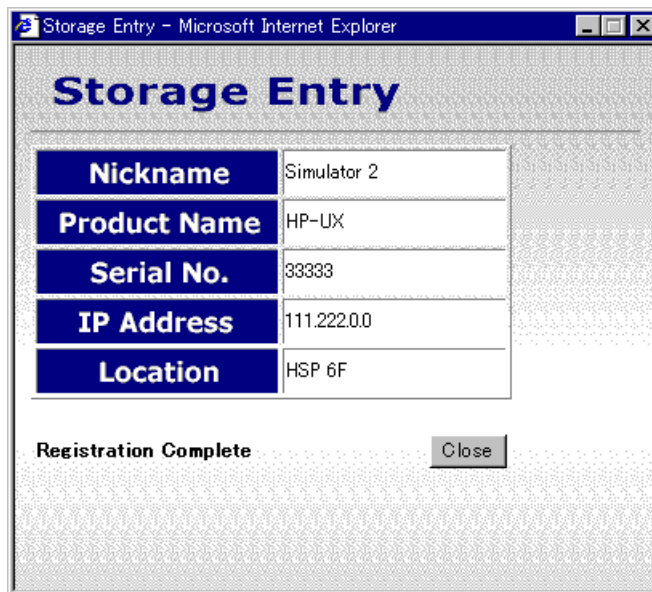



Figure 3.15 Registration Complete Message



### 3.2.3 Changing a Storage Device Entry

To change a 9900V storage device entry:

1. Either log in to the primary SVP, or log out of the Remote Console to access the Logon panel (refer to Figure 3.10).
2. Instead of clicking on a hyperlink to select a subsystem, select the **Mode Changing** icon, which should be in **View** mode ().
3. The Storage Editor - Logon panel (refer to Figure 3.11) will display. Enter your user name and password, and select **Logon** to open the Storage List Editor panel (refer to Figure 3.12). The Mode Changing icon will be in **Modify** mode ().
4. Select the **Edit** button of the desired storage device in the list to open the Storage Entry panel (refer to Figure 3.12).
5. Edit the desired storage device information.
6. Select **Submit** to register the change to the storage device. A confirmation message is displayed (refer to Figure 3.14).
7. Select **OK** to register the change. When the change is successfully registered, a completion message is displayed (refer to Figure 3.15).
8. Select the **Close** button. The changed information is displayed on the Storage Device List panel.

### 3.2.4 Deleting a Storage Device Entry

To delete a 9900V storage device entry:

1. Either log in to the primary SVP, or log out of the Remote Console to access the Logon panel (refer to Figure 3.10).
2. Instead of clicking on a hyperlink to select a subsystem, select the **Mode Changing** icon, which should be in **View** mode (  ).
3. The Storage Editor - Logon panel (refer to Figure 3.11) will display. Enter your user name and password, and select **Logon** to open the Storage List Editor panel (refer to Figure 3.12). The Mode Changing icon will be in **Modify** mode (  ).
4. Select the **Del.** button of the storage device that you want to delete.
5. When a confirmation message is displayed (see Figure 3.16), select **OK** to delete the storage device. The storage device is deleted from the Storage Device List panel.

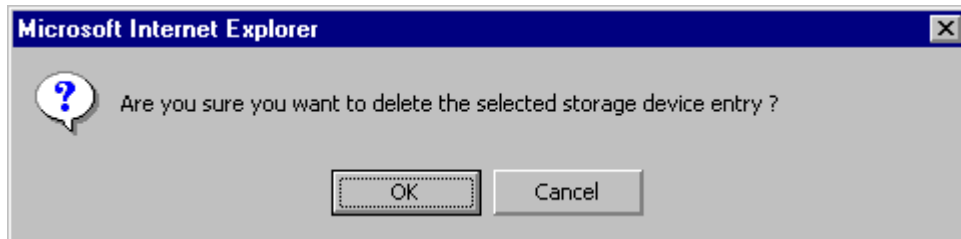

Figure 3.16 Delete Device Confirmation Message

### 3.3 Editing the User Account List (Administrator Only)

**Important:** You must log on as an administrator to edit the user account list. Ordinary users are permitted to view part of their user information and change their own passwords (see section 3.8).

All users of the Remote Console must be registered in the user account list of the connected subsystem (SVP) to log on and use the web client Java™ applet program.

The operations for editing a 9900V Remote Console user account list include:

- Adding user entries (see section 3.3.2),
- Changing user entries (see section 3.3.3), and
- Deleting user entries (see section 3.3.5).

#### 3.3.1 Control Panel, User Entry Tab

To open the **User Entry** tab of the Control panel (see Figure 3.17), select the **Option** button  on the upper right corner of any of the Remote Console panels. The **User Entry** tab is the default view.

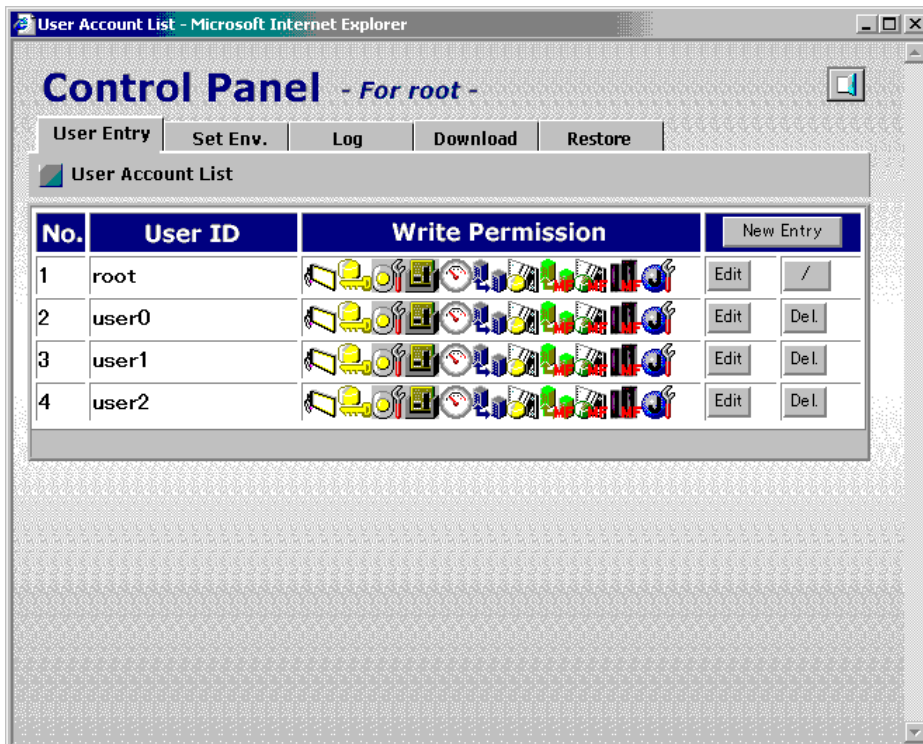



Figure 3.17 Control Panel, User Entry Tab



The **User Entry** Tab displays the User Account List, which includes the following information:

- The **No.** displays the order of user entries. The root user (administrator) is displayed at the top of the user account list. **Note:** The administrator can register up to 500 users, including the root. The administrator sets the maximum number of users from the SVP.
- The **User ID** displays the user name. Each user ID must be unique.
- The Write Permission displays icons for each option for which that user has **Modify** access. See (refer to Figure 3.2) for a list of icons and their corresponding meanings.
- The **New Entry** button opens the User Entry panel (see Figure 3.18), which allows you to add a new user entry.
- The **Edit** button opens the User List Editor panel (see Figure 3.20), which allows you to change the selected user entry.
- The **Del.** button deletes the selected user entry. **Note:** The root user cannot be deleted from the user account list.

The **Exit** button () closes the Control Panel.

### 3.3.2 Adding a New User Entry

To add a new user entry:

1. Select the **Option** button () on any of the Remote Console panels to open the Control panel. The **User Entry** tab is the default view (refer to Figure 3.17).
2. Select the **New Entry** button to open the User Entry panel (see Figure 3.18).
3. Enter the new user's ID and password on the User Entry panel. The user ID is displayed, but the passwords are not. Each entry can be up to 16 alphanumeric characters.
4. Select the appropriate option checkboxes to assign the desired write permissions to the user.
5. Select **Submit** to display the Register User Confirmation message (see Figure 3.19).
6. Select **OK** to register the new user entry, or select **Cancel** to cancel. You are returned to the **User Entry** Tab of the Control panel, and the new user is added to the user account list.

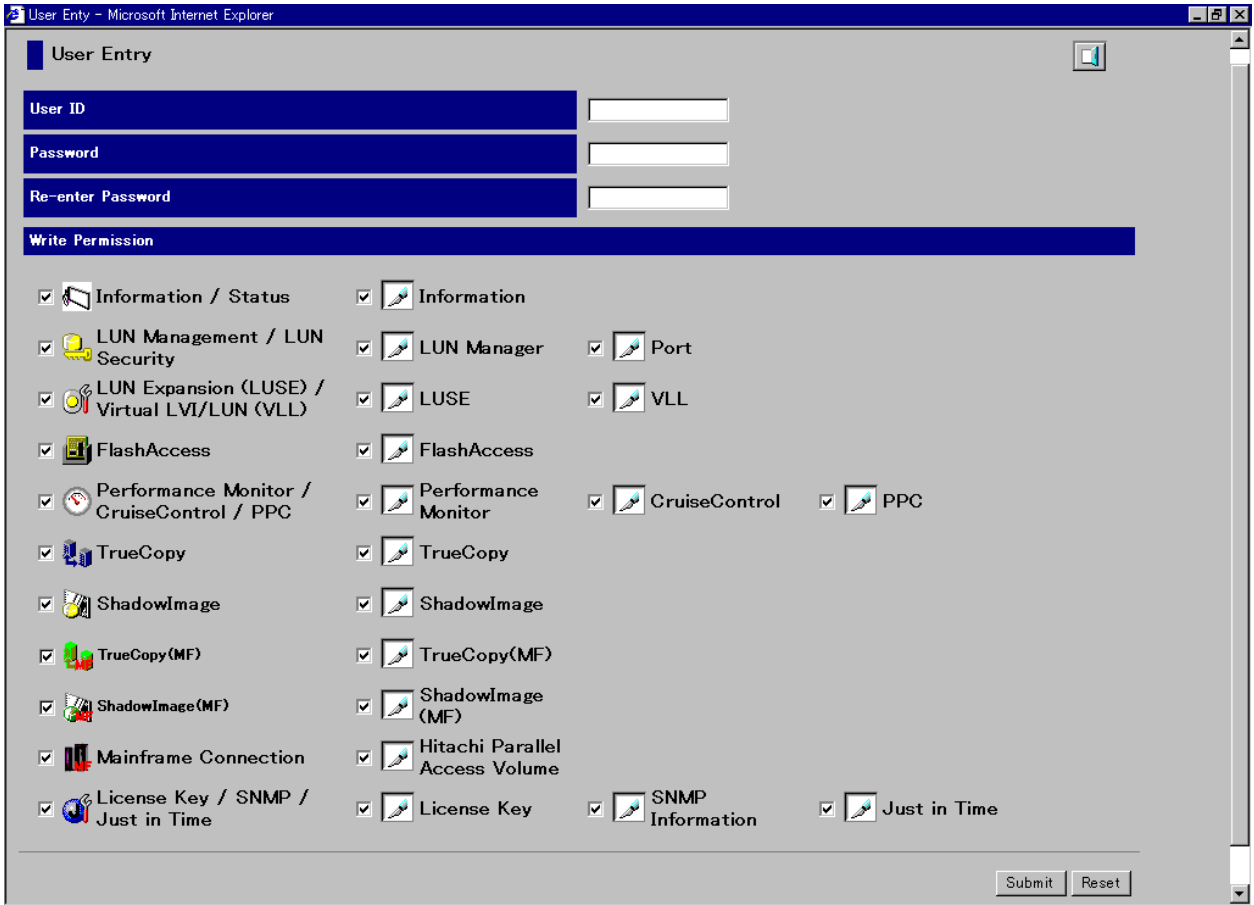

Figure 3.18 User Entry Panel

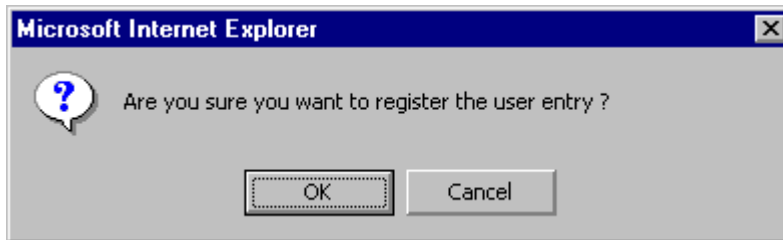



Figure 3.19 Register User Confirmation Message

### 3.3.3 Changing a User Entry

**Note:** You can change a user's write permissions and password, but not the user ID. To change the user ID, you must first delete the user entry, and then add a new user entry with the desired user ID. If you make any change on a tab, you must select the **Submit** button to apply the change before you move to another tab.

To change the write permission:

1. Select the **Option** button () on any of the Remote Console panels to open the Control panel. The **User Entry** tab is the default view (refer to Figure 3.17).
2. On the **User Account** List, select the **Edit** button of the user you want to change, which will open the User List Editor panel. The **Permission** tab is the default view (see Figure 3.20).
3. Change the write permissions by either checking or clearing the checkboxes on the **Permission** tab.
4. Select the **Submit** button.
5. When the Change Permission Confirmation message (see Figure 3.21) is displayed, select **OK** to register the change, or select **Cancel** to cancel.

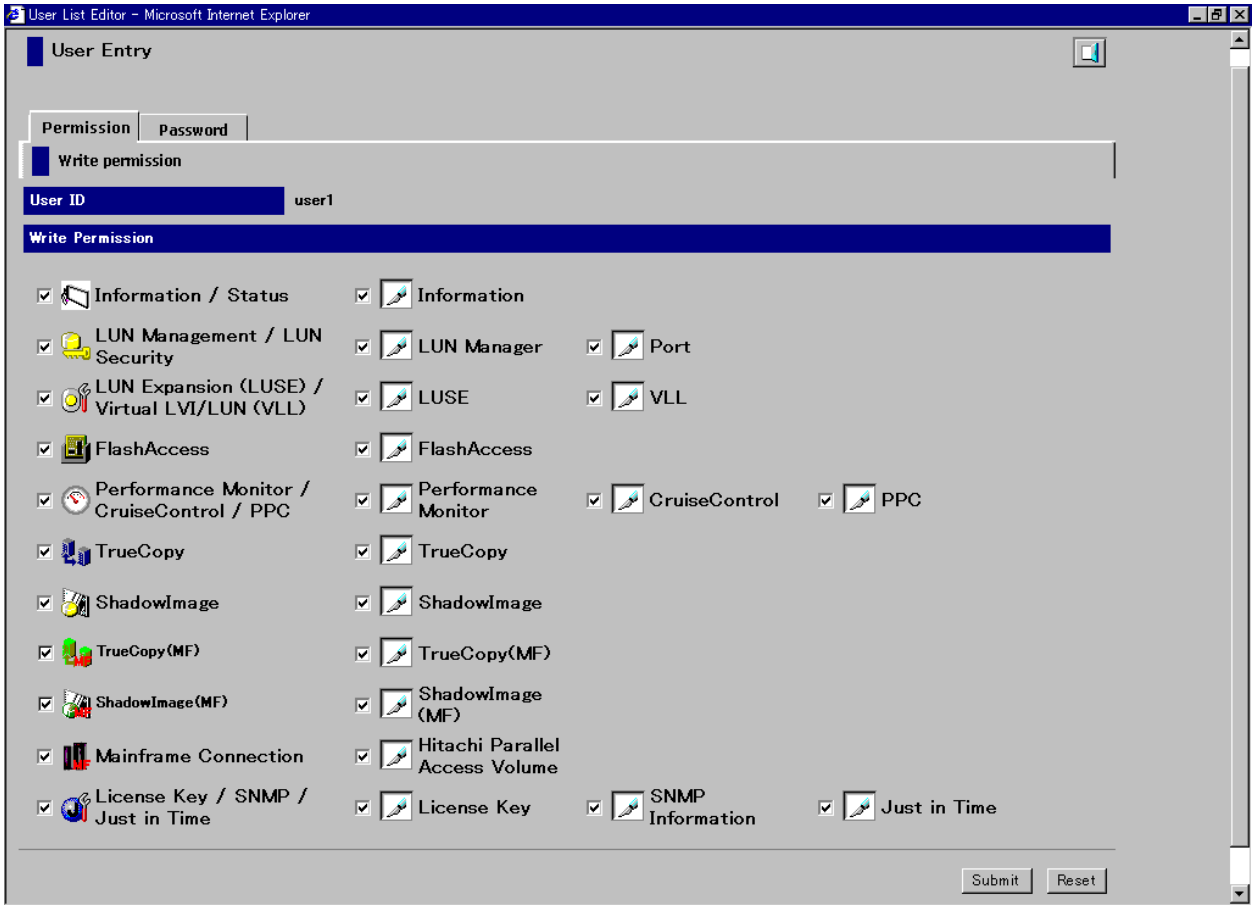

Figure 3.20 User List Editor Panel (Permission Tab)

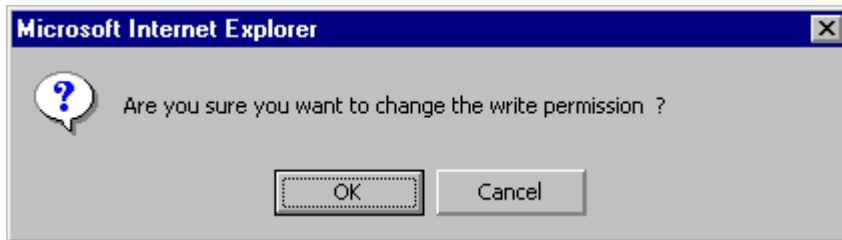



Figure 3.21 Change Permission Confirmation Message

### 3.3.4 Changing a User Password

To change the password:

1. Select the **Option** button (  ) on any of the Remote Console panels to open the Control panel. The **User Entry** tab is the default view (refer to Figure 3.17).
2. On the User Account List, select the **Edit** button of the user you want to change, which will open the User List Editor panel. The **Permission** tab is the default view (refer to Figure 3.20).
3. Select the **Password** tab (see Figure 3.22).
4. Change the password by entering the new password twice. **Note:** To change the administrator's password (root password), you must enter the current password before entering the new password. If the administrator password is lost or forgotten, you must call the Hitachi Technical Support Center in order to regain access to the administrator-only functions.
5. Select the **Submit** button.
6. When the Change Password Confirmation panel displays (see Figure 3.23), select **OK** to register the change, or select **Cancel** to cancel.

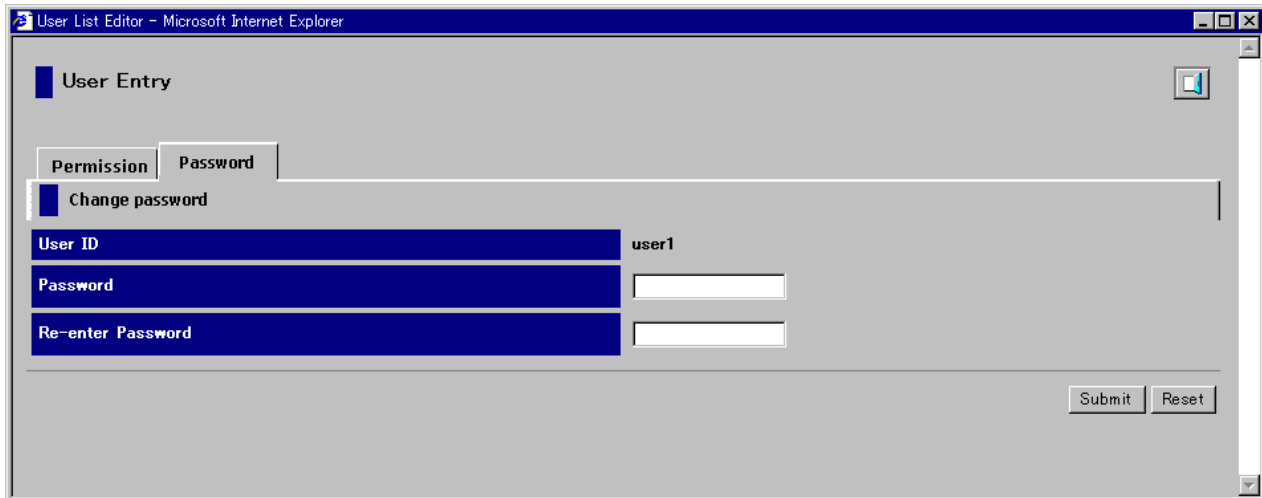

Figure 3.22 User Entry Panel (Password Tab)

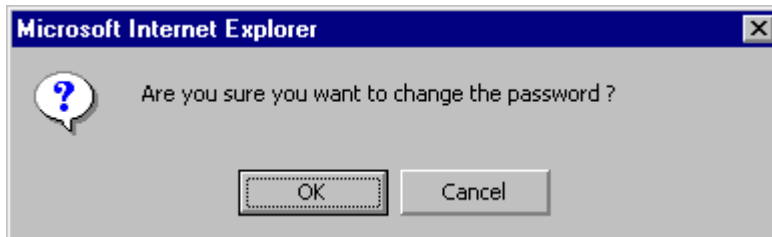



Figure 3.23 Change Password Confirmation Message

### 3.3.5 Deleting a User Entry

To delete a user entry:

1. Select the **Option** button (  ) on any of the Remote Console panels to open the Control panel. The **User Entry** tab is the default view (refer to Figure 3.17).
2. Select the **Del.** button of the user you want to delete.
3. When the Delete User Confirmation message displays (see Figure 3.24), select **OK** to delete the user entry or select **Cancel** to cancel. The user is removed from the user account list.

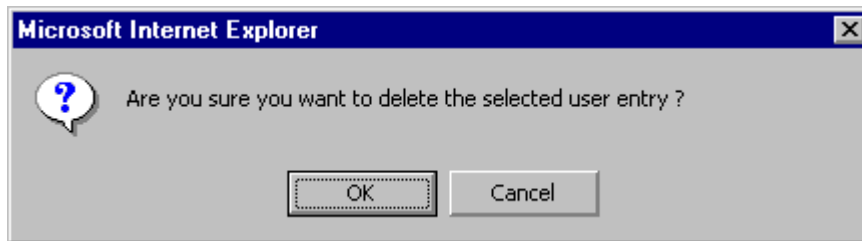



Figure 3.24 Delete User Confirmation Message

### 3.4 Setting the Remote Console Environment Parameters (Administrator Only)

The **Set Environment** tab of the Control panel (see Figure 3.25) allows you to set the following Remote Console environment parameters:

- RMI™ time-out period
- RMI™ time-out period for **Modify** mode
- Polling period for checking exclusive lock
- Polling period for checking status and events.

To access the **Set Environment** tab, select the **Option** button (  ) on any of the Remote Console panels to open the Control panel. The **User Entry** tab is the default view (refer to Figure 3.17). Select the **Set Env.** tab (see Figure 3.25).

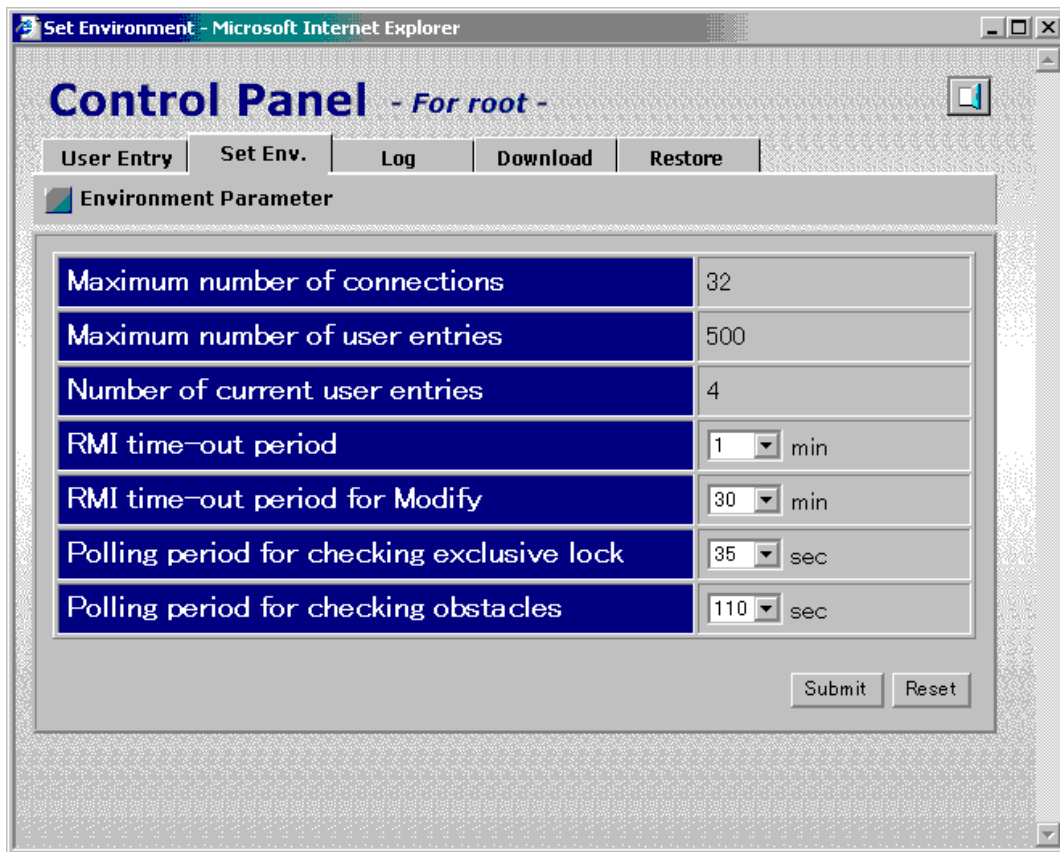

Figure 3.25 Control Panel, Set Environment Tab





The **Set Environment** tab of the Control Panel has the following features:

- **Maximum number of connections:** This sets the maximum number of Remote Console users that can concurrently connect to the same subsystem. **Note:** You cannot change this value from the Remote Console. Contact your Hitachi Data Systems service representative.
- **Maximum number of user entries:** This sets the maximum number of user entries that can be registered in the user account list of a subsystem. **Note:** You cannot change this value from the Remote Console. Contact your Hitachi Data Systems service representative.
- **Number of current user entries:** This shows the number of user entries currently registered in the user account list.
- **RMI™ time-out period:** If the user cannot access the SVP for a certain period of time because of a network error, the RMI™ time-out will log the user off of the SVP. This has the following parameters:
  - You can specify **1, 5 - 60** in 5-minute increments, or **70 to 120** in 10-minute increments. The default is one minute.
  - You can also specify **NO** to disable this parameter. **Note:** If you specify **NO** as the value of the RMI™ time-out period, the user is not logged off automatically when an error occurs, and this might prevent that user from logging in again. This setting is not recommended under ordinary circumstances.
  - The value of the RMI™ time-out period must be greater than the value set for the smallest polling period, either for checking exclusive lock or for checking obstacles (see below for those parameters). For example, specify a value of the RMI™ time-out period parameter to satisfy the following condition: **RMI™ time-out period > min [A, B]**, when **A = Polling period for checking exclusive lock**, **B = Polling period for checking obstacles**, and **min [A, B]** indicates the minimum value selected from **A** and **B**.

- **RMI™ time-out for Modify mode:** If a user is in **Modify** mode but does not make any changes that access the RMI™ server for a specified period of time, **Modify** mode will be released, and that user will return to **View** mode.
  - The default time period is **30 minutes**. You can specify between **10** and **60** minutes in 10-minute increments, or between **120** and **360** minutes in 60-minute increments.
  - You can also specify **No** to disable this feature.
- **Polling period for checking exclusive lock:** If multiple users are viewing the subsystem information in **View** mode, while one user is changing the information in **Modify** mode, the SVP can monitor the user who is changing the subsystem information, and update the information on the Remote Console panels periodically.
  - The default time period is **35 minutes**. You can specify **5 - 60** in 5-minute increments, or **70** to **120** in 10-minute increments.
  - You can also specify **NO** to disable this parameter.
- **Polling period for checking obstacles:** You can specify a time interval to monitor the Disk Controller and Disk Array Unit status, which will be displayed by the status lamp icon on the **Status** tab of the Remote Console Main panel.
  - The default time period is 110 minutes. You can specify **5 - 60** seconds in 5-second increments, **110**, or **120** for the parameter.
  - You can also specify **NO** to disable this parameter.
- The **Submit** button applies the Remote Console settings.
- The **Reset** button resets the Remote Console settings to the defaults.

To set the Remote Console environment parameters:

1. To access the **Set Environment** tab, select the **Option** button () on any of the Remote Console panels to open the Control panel. The **User Entry** tab is the default view (refer to Figure 3.17). Select the **Set Env.** tab (refer to Figure 3.25).
2. Specify the Remote Console parameters as required.
3. Select the **Submit** button.
4. When a confirmation message is displayed, select the **OK** button, or select **Cancel** to cancel.
5. Select the **Exit** button () to close the Control panel.

### 3.5 Viewing the Remote Console Log Information (Administrator Only)

The **Log** tab of the Control panel allows an administrator to view the Remote Console log information, including the access log, the error log, and the operation log. In addition, you can download the Remote Console log information (see section 3.6).

To access the **Log** tab, select the **Option** button (  ) on any of the Remote Console panels to open the Control panel. The **User Entry** tab is the default view (refer to Figure 3.17). Select the **Log** tab (see Figure 3.26).

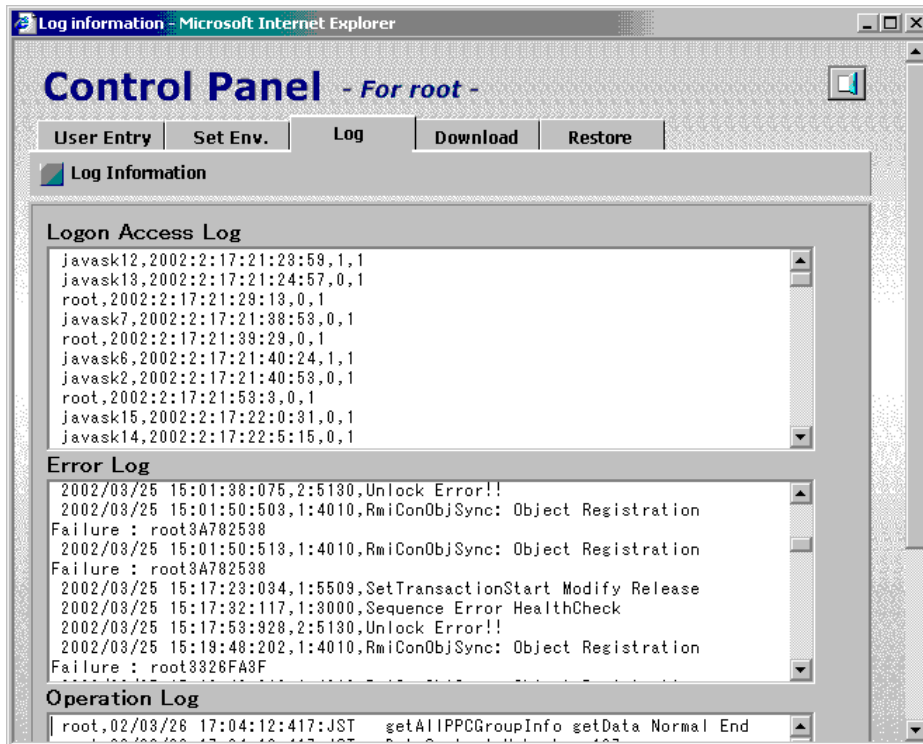



Figure 3.26 Control Panel, Log Tab

The **Log** Tab of the Control panel displays the following features:

- **Logon Access Log:** The logon access log includes the user ID, logon and logoff date and time, and flag for all users who log on to the SVP.
- **Error Log:** The error log includes the date and time of error, error code, error type, and description of the RMI™ objects.
- **Operation Log:** The operation log includes the user ID, date and time of the operation, and operation type (method).

To view the Remote Console log information:

1. To access the **Log** tab, select the **Option** button () on any of the Remote Console panels to open the Control panel. The **User Entry** tab is the default view (refer to Figure 3.17). Select the **Log** tab (refer to Figure 3.26).
2. View the information on the **Log** tab.
3. Select the **Exit** button () to close the Control panel.

### 3.6 Downloading the Log and Configuration Files (Administrator Only)

The **Download** tab of the Control panel allows you to download files of the Remote Console log information such as error log, access log, and operation log, as well as files of the Remote Console configuration information such as storage device list, user account list, and environment parameter list.

To access the **Download** tab, select the **Option** button (  ) on any of the Remote Console panels to open the Control panel. The **User Entry** tab is the default view (refer to Figure 3.17). Select the **Download** tab (see Figure 3.27).

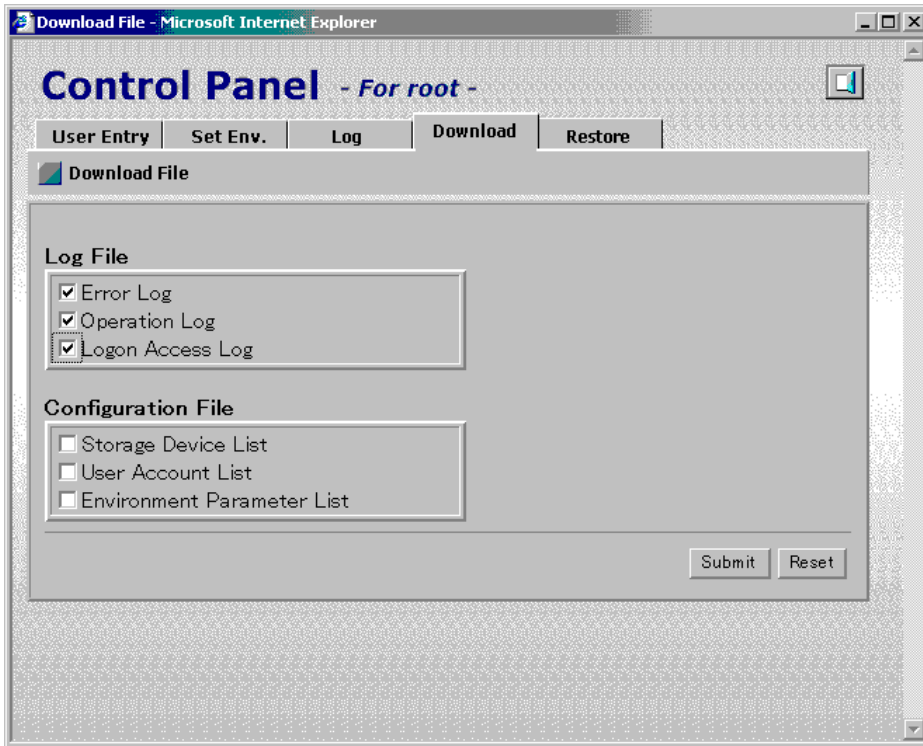



Figure 3.27 Control Panel, Download Tab

The Download File panel has the following features:

- The **Log File** box displays the following checkboxes:
  - **Error Log**
  - **Operation Log**
  - **Logon Access Log**
- The **Configuration File** box displays the following checkboxes:
  - **Storage Device List**
  - **User Account List**
  - **Environment Parameter List**
- The **Submit** button opens the Download panel (see Figure 3.28) to download the selected files.
- The **Reset** button clears all the checkboxes.

To download log and configuration files:

1. To access the **Download** tab, select the **Option** button (  ) on any of the Remote Console panels to open the Control panel. The **User Entry** tab is the default view (refer to Figure 3.17). Select the **Download** tab.
2. Check the checkboxes of the desired files.
3. Select the **Submit** button. The Download panel (see Figure 3.28) opens.
4. Confirm that the selected files are marked with a colored icon, and then select **Download**. The File Download panel (see Figure 3.29) opens.
5. Select **Save this file to disk**, then select **OK**. The Save As panel (see Figure 3.30) opens. **Note:** The compressed file to be downloaded is automatically named, however, you can change the name.
6. Specify the name of a folder to save the compressed file, and select the **Save** button. When download is complete, the Download Complete panel appears (see Figure 3.31)
7. Select the **Close** button to close the Download Complete panel.
8. Decompress the downloaded file (\*.lzh) as required. **Note:** For instructions on how to decompress the file, refer to the manual or online help of the tool you use.

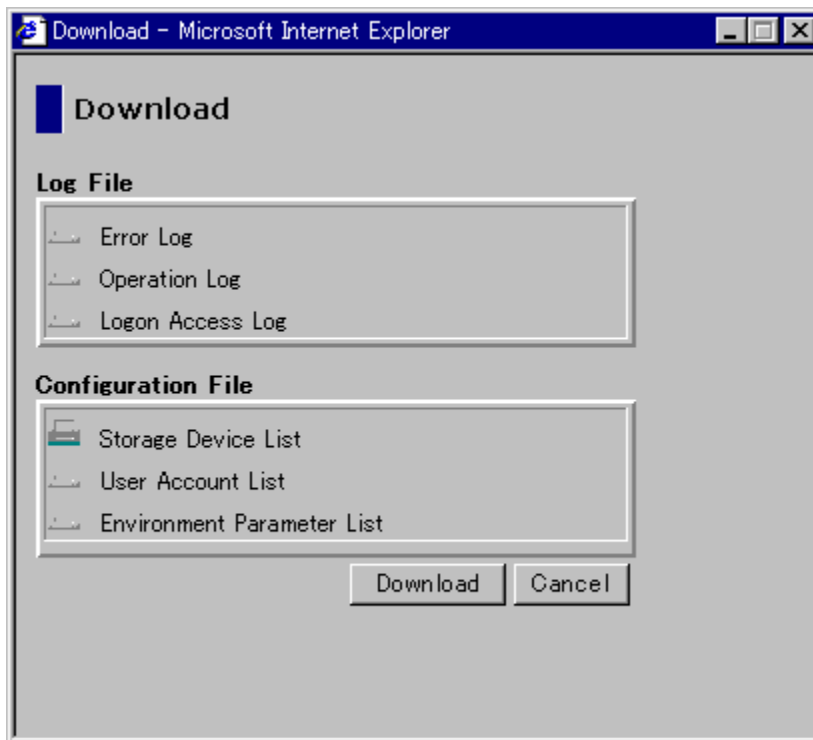

Figure 3.28 Download Panel



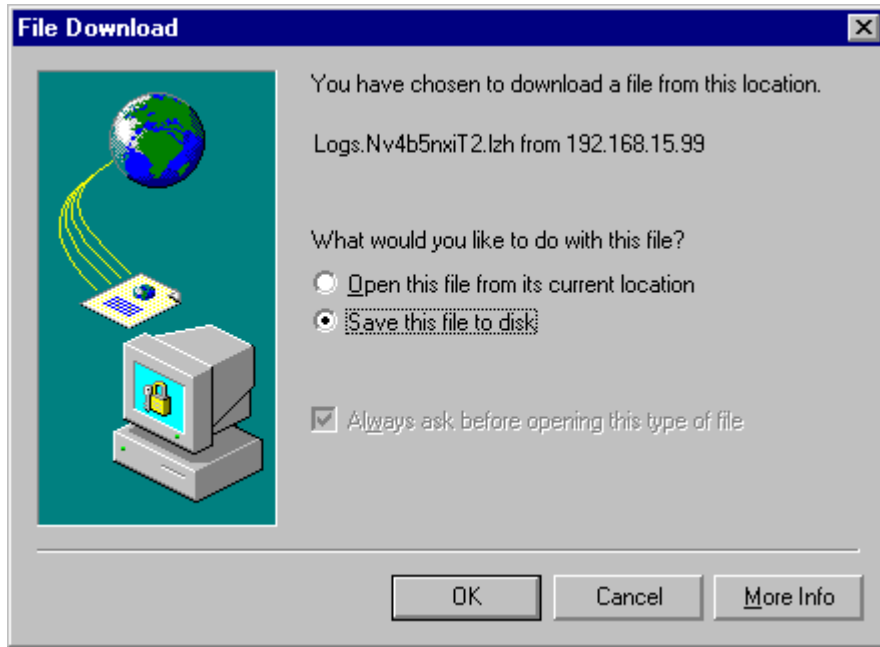

Figure 3.29 File Download Panel

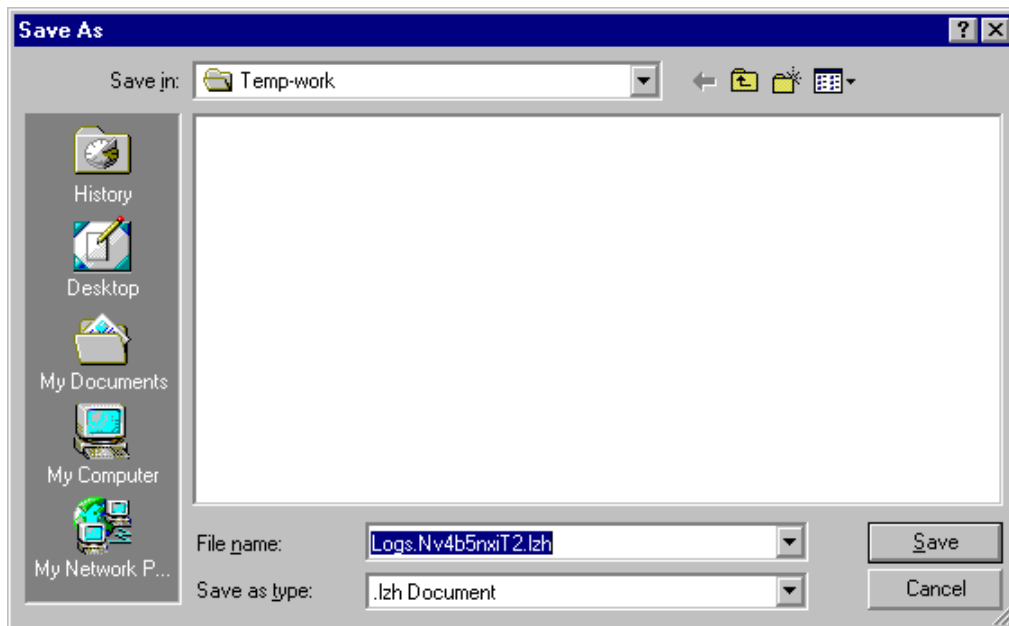

Figure 3.30 Save As Panel

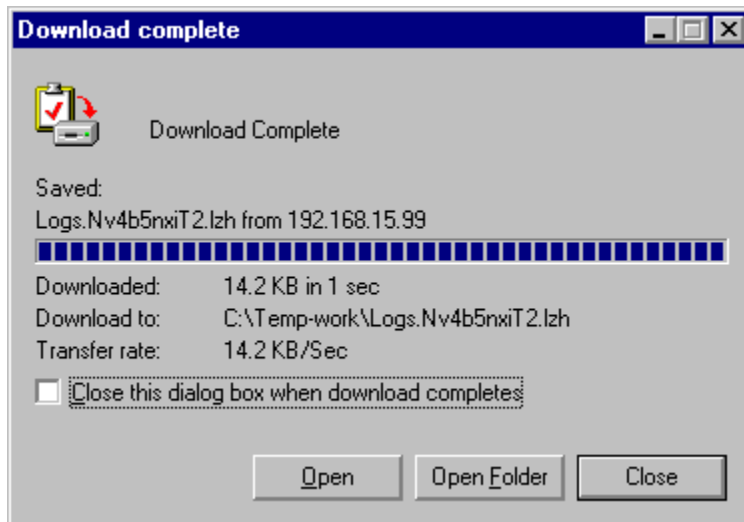



Figure 3.31 Download Complete Panel

### 3.7 Restoring Backup Files (Administrator Only)

**Warning:** This operation requires extreme caution, because if you forget the password or upload the files, you could cause an unrecoverable error. Contact the Hitachi Data Systems Service Center if you need assistance (see section 5.2).

#### 3.7.1 Control Panel, Restore Tab

To open the **Restore** tab of the Control panel (see Figure 3.32), select the **Option** button  on the upper right corner of any of the Remote Console panels. The **User Entry** tab is the default view. Select the **Restore** tab.

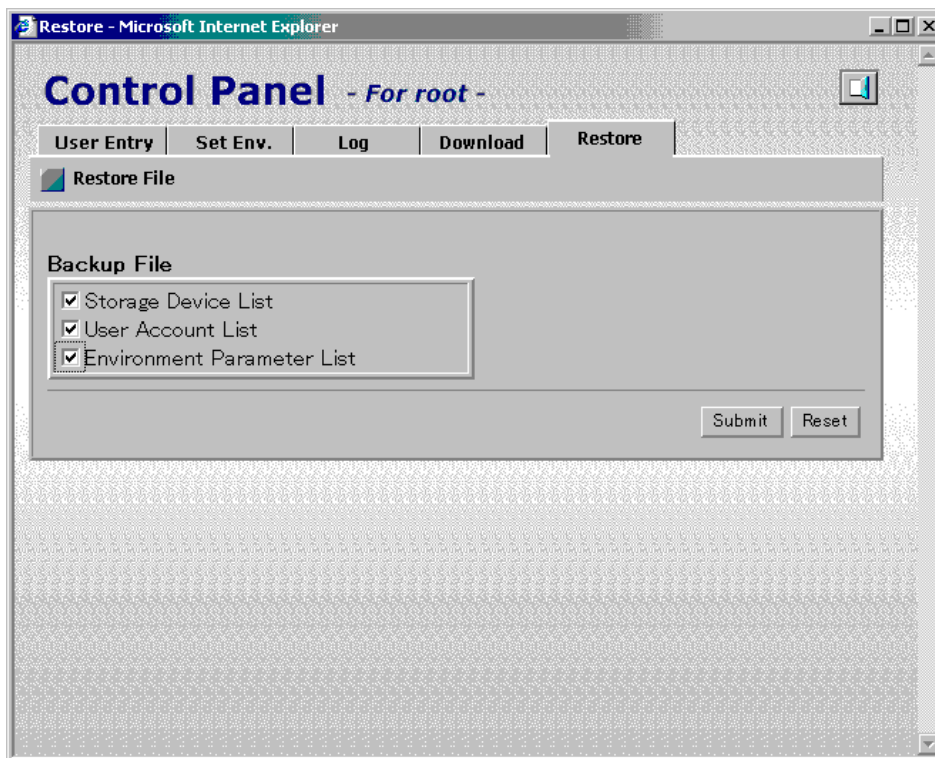



Figure 3.32 Control Panel, Restore Tab

The **Restore** tab has the following characteristics:

- The **Backup File** box allows you to select one or more of the following lists to be restored:
  - Storage Device List
  - User Account List (requires administrator password for that list)
  - Environment Parameter List
- The **Submit** button starts restoring the selected files.
- The **Reset** button clears all the checkboxes.

### 3.7.2 Restoring Backup Files

Before you can restore any type of configuration, you must first have uploaded the storage device list (strlist.cvs), user account list (userlist.cvs) and/or the environment parameters (env.cvs) to the SVP using the FTP Client function (see section 3.12).

1. To access the **Set Environment** tab, select the **Option** button () on any of the Remote Console panels to open the Control panel. The **User Entry** tab is the default view (refer to Figure 3.17). Select the **Restore** tab (refer to Figure 3.32). **Note:** If you have not previously uploaded the configuration files to the SVP, the Backup File Not Found panel (see Figure 3.33) will display.
2. Select the checkboxes of the files that you want to restore.
3. Click the **Submit** button.
4. If you selected the **User Account List** checkbox, the Password check panel (see Figure 3.34) will open. Enter the administrator (root) password of the desired user account list twice, then select the **Submit** button on the Password check panel. **Note:** If the password is not correct, the user account list cannot be restored.
5. The password that is entered becomes the administrator (root) password after the file restore process.
6. The File Restoration Confirmation panel (see Figure 3.35) will be displayed.
7. Confirm the process has been completed successfully, then select the **Close** button on the Restore confirmation panel to close the panel.

**Note:** When the file restore process is successfully completed, the backup file of the SVP is deleted.

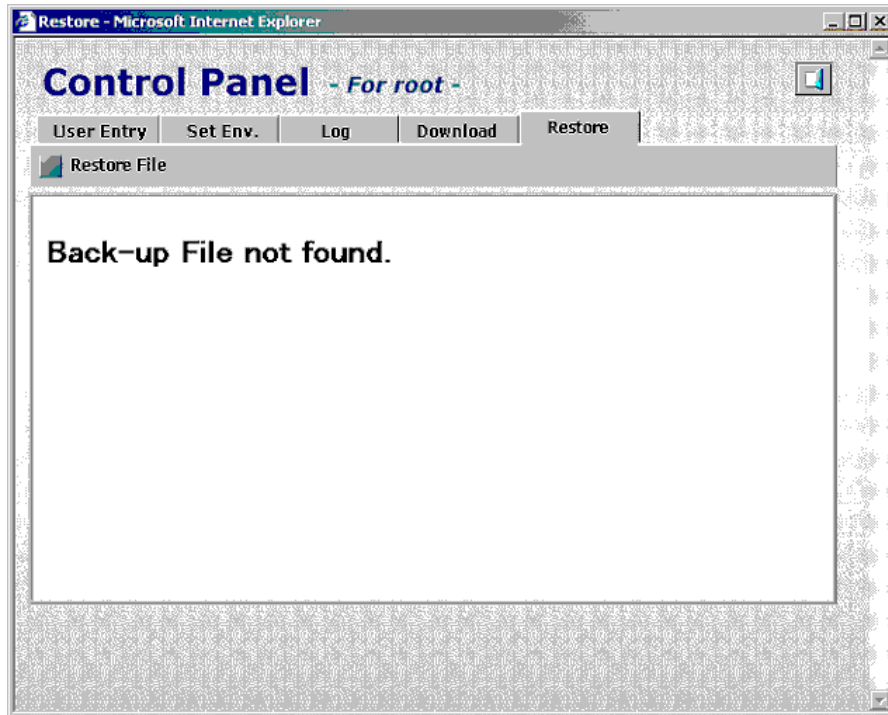

Figure 3.33 Backup File Not Found Panel

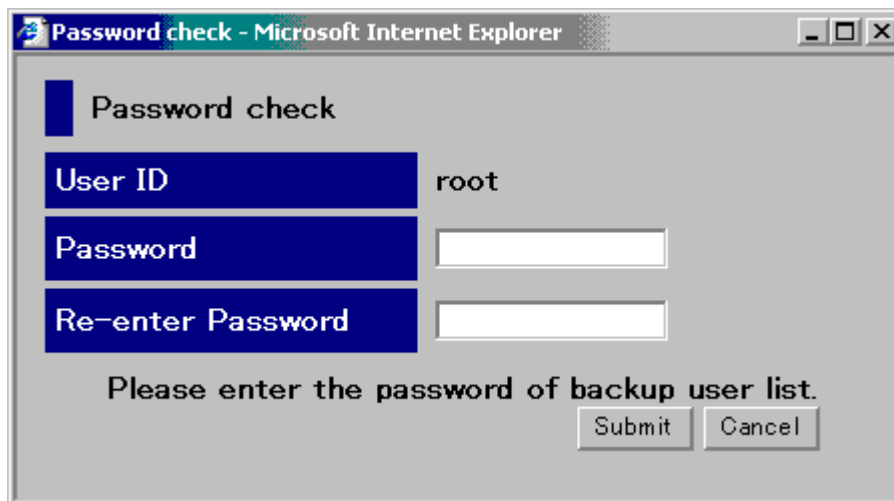

Figure 3.34 Password Check Panel

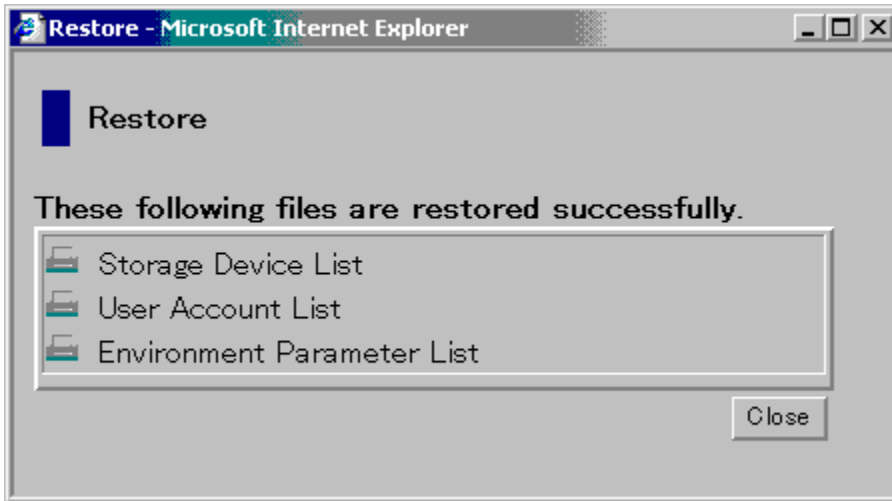



Figure 3.35 File Restoration Confirmation Panel

## 3.8 Viewing Your Own User Permissions and Changing Your Own Password

### 3.8.1 Viewing Your User Permissions

To view your own write permissions for the Remote Console options:

1. Log on as a non-administrator to the SVP to open the Remote Console Main panel.
2. Select the **Option** button (  ) to open the User Control panel. The **Permission** tab is the default view. (see Figure 3.36).
3. Select the **Exit** button (  ) to exit the panel and return to the Remote Console Main panel.

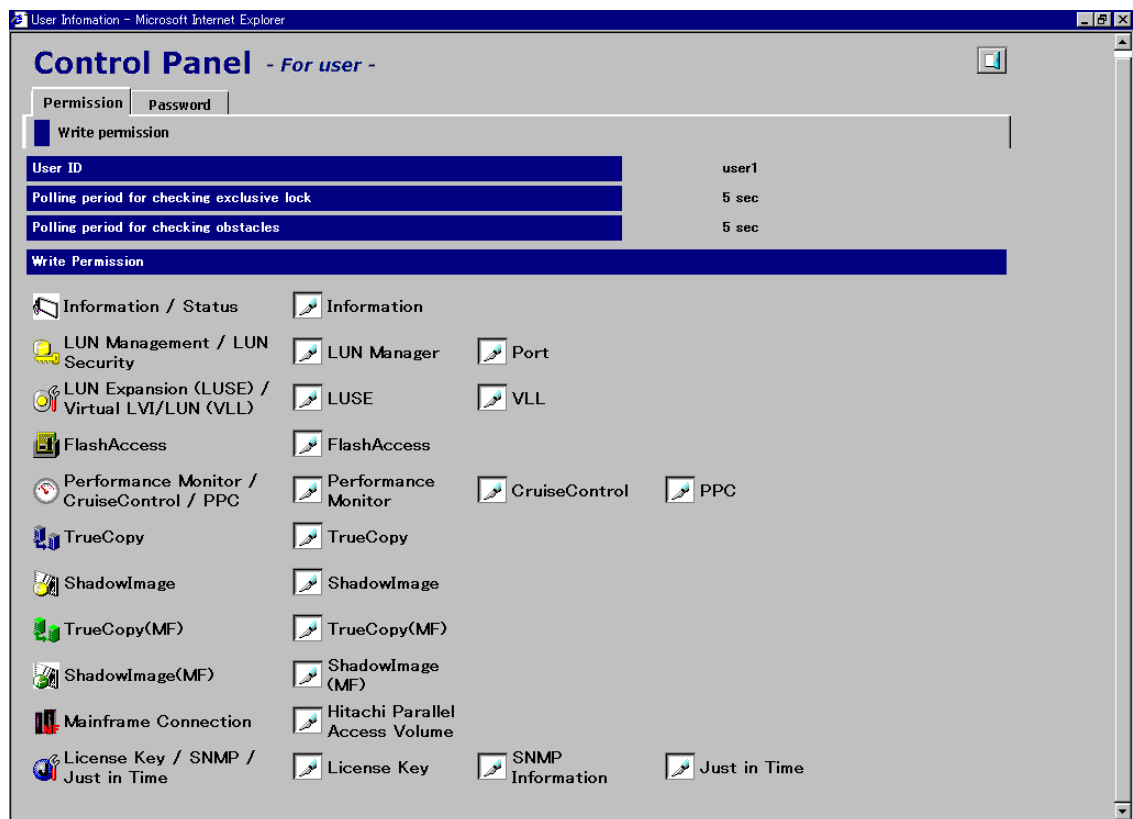



Figure 3.36 User Control Panel, Permission Tab

### 3.8.2 Changing Your Password

To change your own password:

1. Log on as a non-administrator to the SVP to open the Remote Console Main panel.
2. Select the **Option** button (  ) to open the User Control panel. The **Permission** tab is the default view. (see Figure 3.36).
3. Select the **Password** tab (see Figure 3.37).
4. Enter the current password in the **Current Password** box. Enter the new password in the **New Password** and **Re-enter New Password** boxes
5. Select the **Submit** button.
6. When a confirmation message is displayed, select the **OK** button. The new password is registered and the information on the **Password** tab is reset.
7. Select the **Exit** button (  ) to close the User Information panel.

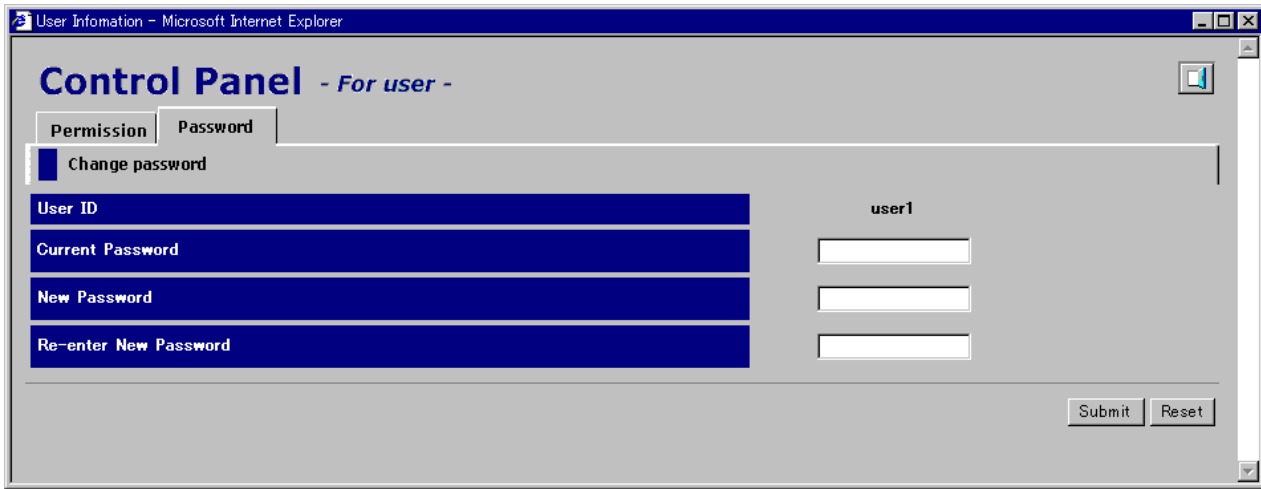

Figure 3.37 User Control Panel, Password Tab



### 3.9 Extending Cache Memory and LUs by Using the Just in Time Storage Functions

**Important:** There is an extra charge for making subsystem configuration changes using the Just in Time Storage functions. Because of this, assigning write permission for these functions to non-administrators is not recommended.

The 9900V subsystem is equipped with additional cache memory and LUs that are ordinarily not available. You can access some or all of the additional capacity by using the Just in Time Storage functions. Once this additional capacity is released, the additional memory and/or LUs are available for normal use. You can set the Just in Time Storage functions using the Remote Console, as described in this section. The Just in Time Storage functions can also be set by Hitachi Data Systems representatives on a fee-for-service basis. Contact your Hitachi Data Systems representative for more information.

**WARNING:** Once you have extended the cache memory or the LUs using the Just in Time Storage functions, you will not be able to undo your request, and you will be charged for access to the additional capacity.

The Just In Time Storage operations include:

- Extending the number of LUs using the Just in Time Storage LUN function (see section 3.9.2) and
- Extending cache memory using the Just in Time Storage Cache function (see section 3.9.3).

### 3.9.1 License Key/SNMP/Just in Time Panel, Just in Time Tab

The **Just in Time** tab allows you to extend the number of LUs and cache memory using the Just In Time Storage functions. To open the **Just in Time** tab, select the **License Key/SNMP/Just In Time** button  on the Remote Console Main panel (refer to Figure 3.1), and then select the **Just in Time** tab (see Figure 3.38).

**Note:** If there is a maintenance operation in progress on the SVP, the information on the Just in Time panel might not be updated. If this is the case, close and then reopen the Just in Time panel after the maintenance operation is finished.

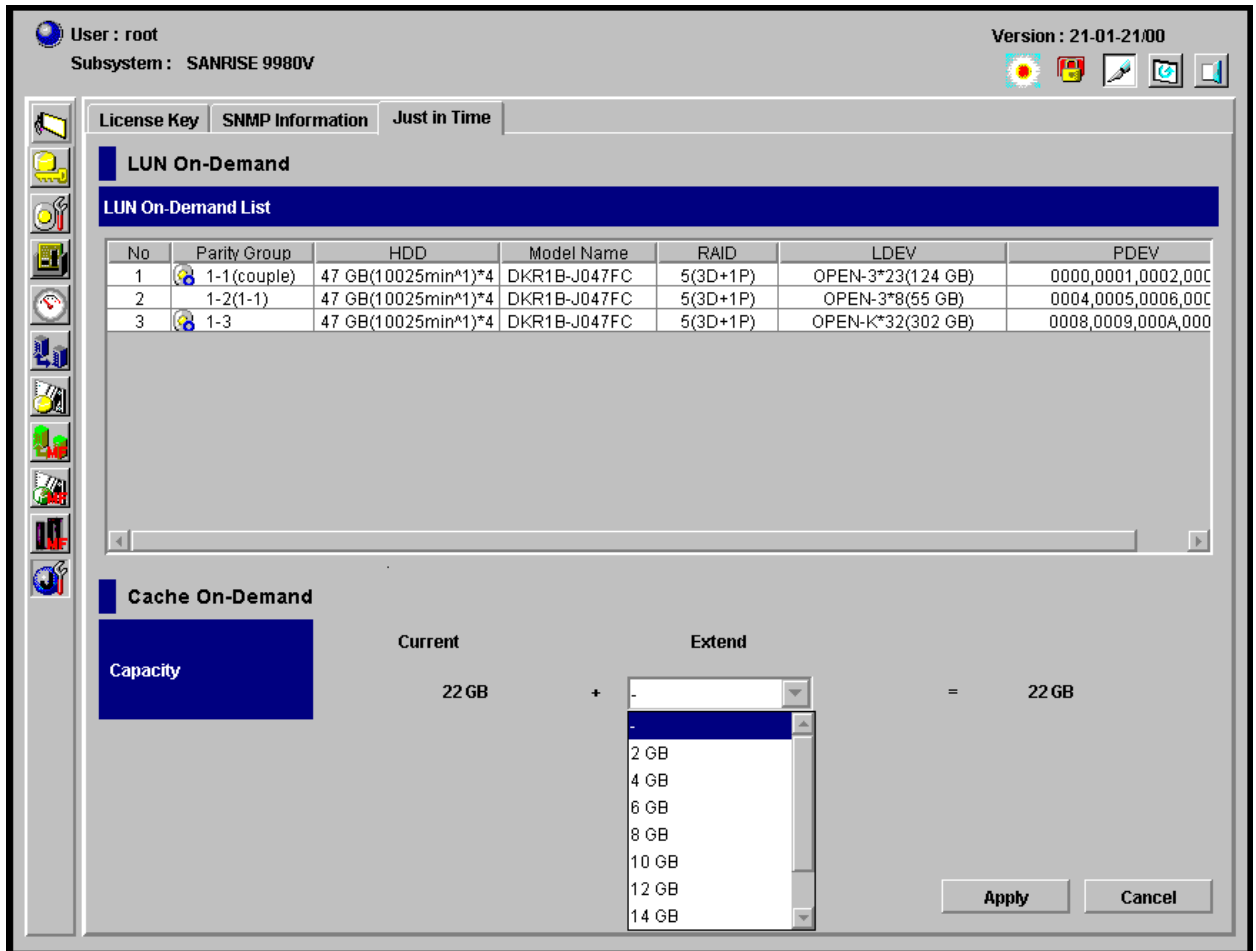



Figure 3.38 License Key/ Just in Time/SNMP Panel, Just in Time Tab

The **Just in Time** tab of the License Key/Just in Time/SNMP panel has the following features:

- The **LUN On-Demand** section displays a list of parity groups that are available for the Just In Time LUN function (**LUN On-Demand List**):
  - The **No.** column lists the serial numbers.
  - The **Parity Group** column lists the parity group numbers. The **Available**  icon indicates that the parity group is available for extension by the Just in Time LUN function, and the **Not Available**  icon indicates that the parity group has already been specified for extension by the Just in Time LUN function.
  - The **HDD** column lists the capacity and speed of the disk volume:  $X \text{ GB } (Y \text{ min}^1) * Z$  (where  $X$  = capacity of disk volume,  $Y$  = speed, and  $Z$  = number of PDEVs).
  - The **Model Name** column lists the PDEV models of parity groups.
  - The **RAID** column lists the RAID levels of the parity groups.
  - The **LDEV** column lists the emulation types of LDEVs in each parity group, the numbers of LDEVs, and their available capacity.
  - The **PDEV** column lists the PDEV numbers of all PDEVs in each parity group.
- The **Cache On-Demand** section displays the **Extend** box and fields that shows the current and total cache capacity in gigabytes.
- The **Extend** drop-down box allows you to select the incremental cache capacity in gigabytes.
- The **Apply** button implements the settings.
- The **Cancel** button cancels the settings.

### 3.9.2 Extending LUs Using the Just in Time Storage LUN Function

To extend the LUNs on the 9900V subsystem:

1. Log on as an administrator to open the Remote Console Main panel (refer to Figure 3.1).
2. Select the **License Key/Just in Time/SNMP** button on the Remote Console Main panel, and then select the **Just in Time** tab (refer to Figure 3.38).
3. In the **Parity Group** column of the **LUN On-Demand List**, right-click on the desired parity group with the **Available** icon. The **On-Demand ON -> OFF** command (see Figure 3.39) is displayed.
4. Select the **On-Demand ON -> OFF** command.
5. When a confirmation panel appears (see Figure 3.40), asking you to confirm that you agree to be charged for access to the additional parity group, select **OK** to agree, or select **Cancel** to disagree.
6. Confirm that the **Available** icon of the selected parity group in the **Parity Group** column has changed to the **Not Available** icon. **Important:** To implement the setting, you must select the **Apply** button (see below).
7. **Note:** If you have changed the status of a wrong parity group by mistake, right-click on the parity group and select the **On-Demand OFF -> ON** command (see Figure 3.39). The **Not Available** icon will change back to the **Available** icon.
8. If you want to apply the changes to the subsystem, select **Apply** and then select **OK** on the confirmation message (refer to Figure 2.13).
9. If you want to cancel the changes and not apply them to the subsystem, select **Cancel** and then select **OK** on the confirmation message (refer to Figure 2.14).



Figure 3.39 On-Demand Menu Commands (Left: Changing ON to OFF, Right: Changing OFF To ON)  
(From the License Key/ Just in Time/SNMP Panel, Just in Time Tab)

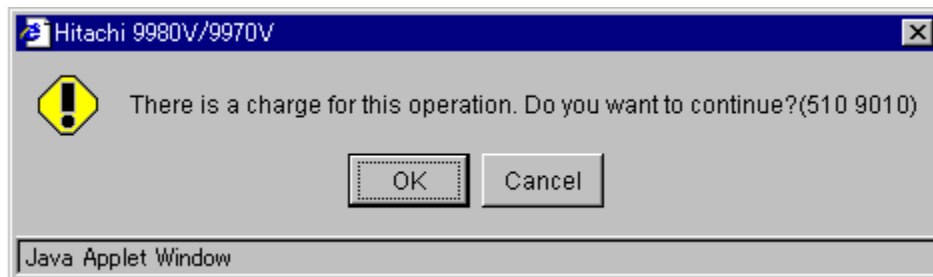



Figure 3.40 Just in Time Confirmation Message

### 3.9.3 Extending Cache Memory Using Just in Time Storage Cache Function

To extend the cache memory on the 9900V subsystem:

1. Log on as an administrator to open the Remote Console Main panel (refer to Figure 3.1).
2. Select the **License Key/Just in Time/SNMP**  button on the Remote Console Main panel, and then select the **Just in Time** tab (refer to Figure 3.38).
3. Select a desired incremental value (cache capacity) from the **Extend** combo box.
4. Confirm that the total capacity (existing cache + additional cache) is correctly displayed.
5. When a confirmation message appears, asking you to confirm that you want to add access to the additional capacity, select **OK** to implement the change, or select **Cancel** to cancel your request. **Important:** To implement the setting, you must select the **Apply** button (see below).
6. If you want to apply the changes to the subsystem, select **Apply** and then select **OK** on the confirmation message (refer to Figure 2.13).
7. If you want to cancel the changes and not apply them to the subsystem, select **Cancel** and then select **OK** on the confirmation message (refer to Figure 2.14).

**WARNING:** Once you select the **OK** button, you cannot cancel or undo your request, and you will be charged for access to the additional capacity.

### 3.10 Downloading Trace Files Using the FD Dump Tool

The 9900V Remote Console supports the **FD Dump Tool** function. The FD Dump Tool function is available to all users, and enables users to download the 9900V Remote Console configuration information from the SVP either onto a floppy disk or onto a hard disk drive. The downloaded information (trace files) can be used by Hitachi Data Systems service personnel to diagnose problems related to Remote Console operations for troubleshooting purposes.

**Note:** If you are unable to resolve an error condition, first copy the 9900V Remote Console configuration information onto floppy disk(s) using the **FD Dump Tool** function. Contact the Hitachi Data Systems Technical Support Center (see section 5.2), and give the information on the floppy disk(s) to the Hitachi Data Systems service personnel.

**Caution:** If another user (including SVP user) is using the **FD Dump Tool** function or **Export File** function, or a maintenance operation is being performed, you cannot download trace files using the **FD Dump Tool** function.

To download the Remote Console configuration information (trace files) from the SVP:

1. Start a web browser on the Remote Console.
2. To open the Download Trace Files Logon panel (see Figure 3.41), specify the following URL (where xxx.xxx.xxx.xxx is the IP address of the SVP):  
`http://xxx.xxx.xxx.xxx/cgi-bin/utility/stc0000.cgi`  
**Note:** You will probably want to add this URL to your “favorites” file.
3. Enter your user ID and password, then select the **Logon** button, to open the Download Trace Files Selecting Trace Files panel (see Figure 3.42).
4. Select the **Normal Trace** button, then select the **Next >>** button. This will compress the file (see Figure 3.43).
5. When the file is compressed, the Download Trace Files Download panel (see Figure 3.44) is displayed.
6. If the web browser ends abnormally due to a time-out or an error, wait for about 10 minutes, restart the **FD Dump Tool** function, and from the Download Trace Files Selecting Trace Files panel (see Figure 3.42) select **Existing Trace File**. Continue with the rest of the instructions.
7. Select the **Download** button. The File Download panel (see Figure 3.45) is displayed.
8. Select **Save this file to disk**, and then select **OK**. The Save As panel (see Figure 3.46) is displayed.
9. Specify the download destination, and then select the **Save** button. When the file is downloaded successfully, the Download Complete panel (see Figure 3.47) is displayed.

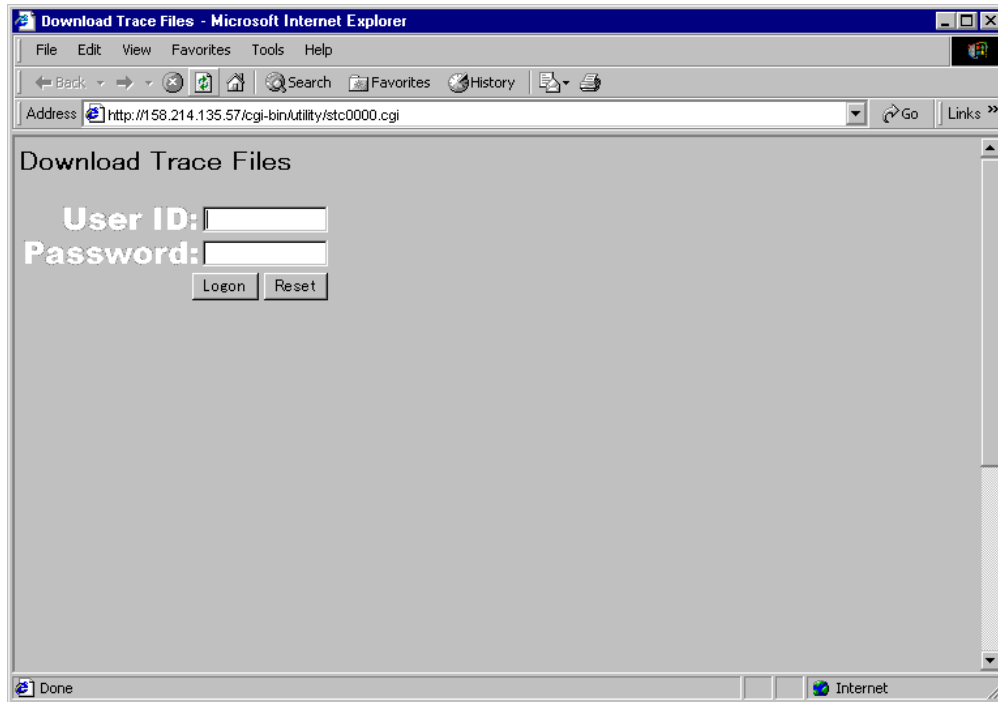

Figure 3.41 Download Trace Files Logon Panel

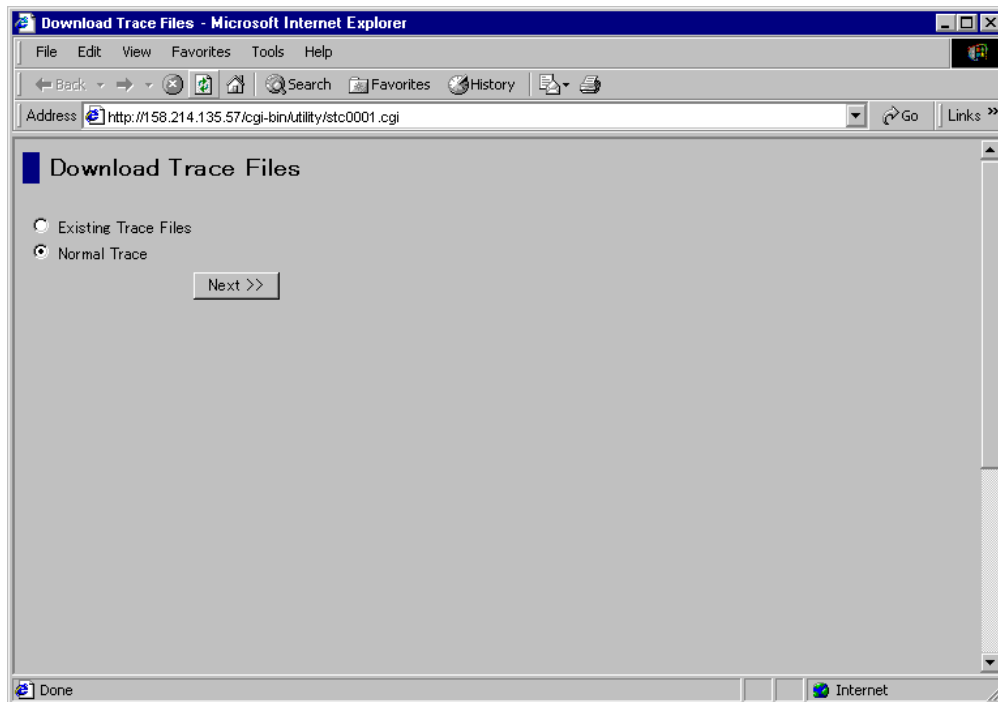

Figure 3.42 Download Trace Files Panel (Selecting Trace Files)



Figure 3.43 Compressing Files Panel

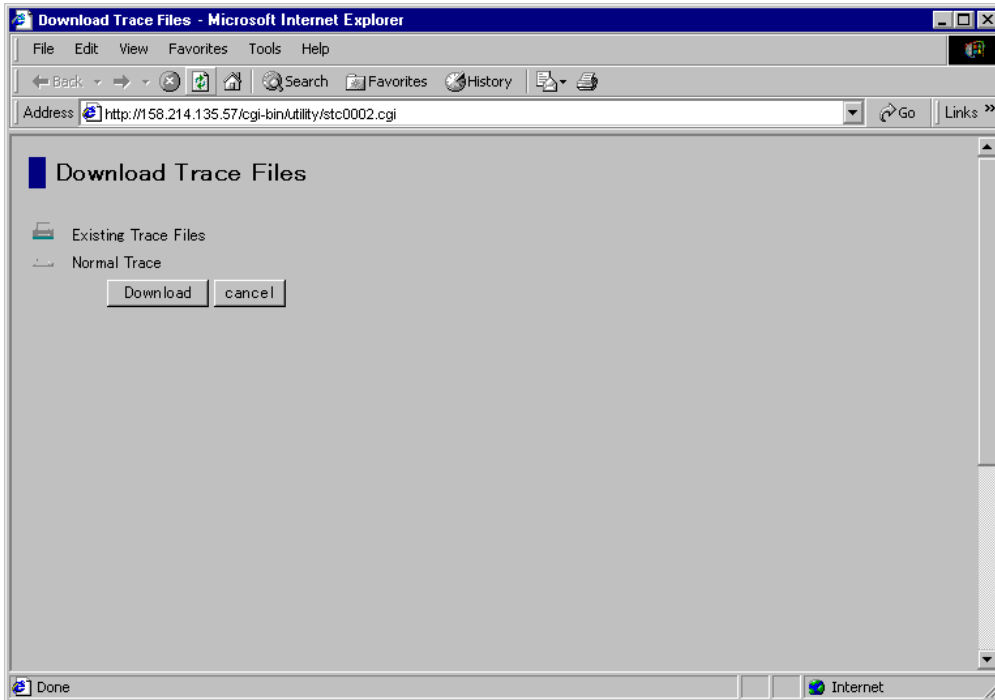

Figure 3.44 Download Trace Files Download Panel



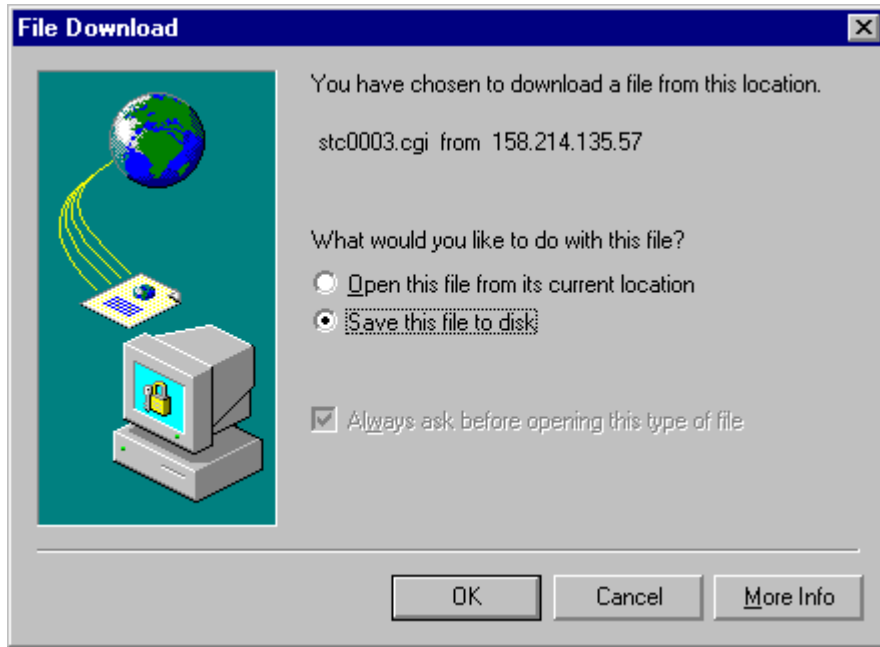

Figure 3.45 File Download Panel

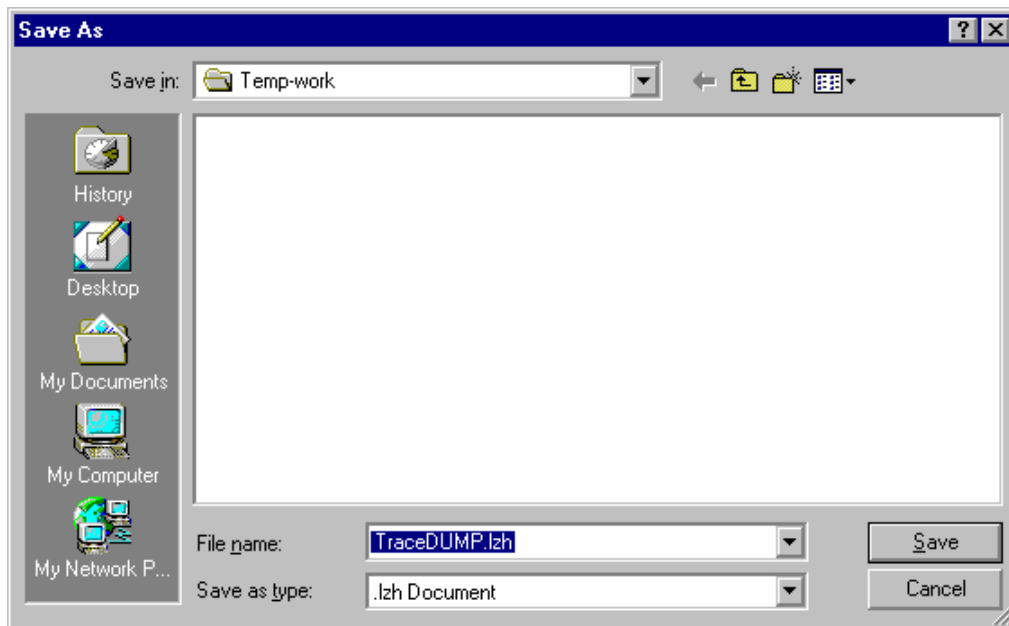

Figure 3.46 Save As Panel

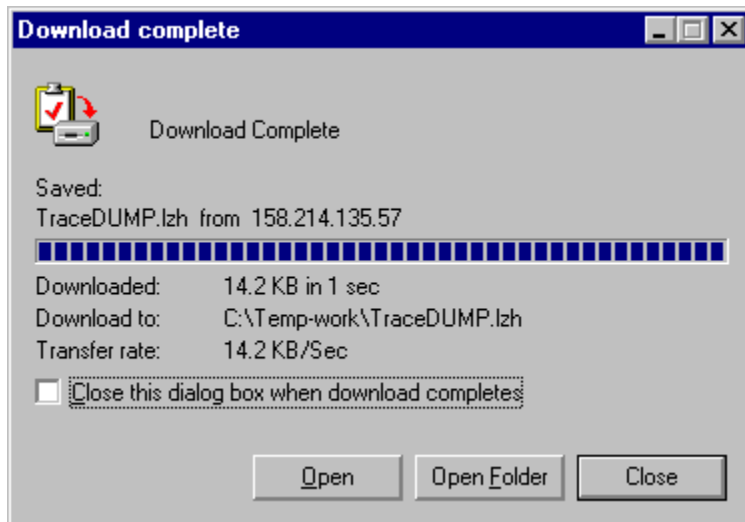



Figure 3.47 Download Complete Panel

### 3.11 Exporting Data Using the Export File Function

The 9900V Remote Console supports the **Export File** function. The **Export File** function enables users to export data used by Remote Console options such as Hitachi CruiseControl, Priority Access, Hitachi TrueCopy, and Hitachi TrueCopy - S/390® to files.

**Note:** Keep the following points in mind before using the Export File function:

- When another user (including the SVP) is using the **FD DUMP Tool** or **Export File** function, or maintenance operations are being performed on the SVP, you cannot use the **Export File** function.
- The web browser sometimes ends abnormally while downloading a file. If this occurs, restart the **Export File** function and retry the operation.
- If you accidentally select the **Cancel** button on another panel during the file compression processing, close the Compressing File panel by selecting the **Close** button () , wait for a while and then restart the **Export File** function to continue processing.

To export data to a file using the **Export File** function:

1. On the Remote Console Main panel, select the **Export** button () to open the Export Data Files panel (see Figure 3.48).
2. On the Export Data Files (Selecting Data) panel, select the button of desired data. For example, select the **Remote Copy Usage** button.
3. Select the **Next >>** button. The Export Data Files (New Data) panel (see Figure 3.49) or the Export Data Files (Export Data) panel Figure 3.50) is displayed.
4. If you export the data for the first time, select the **Export Data** button. **Note:** If you have previously exported the data, you can also select the **Existing Export Data** button. In this case, go to step 5 and then go to step 7.
5. Select the **Download** button. A confirmation message asking whether to compress the file is displayed.
6. Select the **OK** button. A file compression processing starts, and the Compressing File panel is displayed. When the file is compressed, the File Download panel is displayed.  
**Note:** An error occurs if another user is using the **FD DUMP Tool** or **Export File** function, or maintenance operations are being performed on the SVP. If this occurs, wait for a while, and then retry the operation.
7. On the File Download panel, select the **Save this file to disk** button, and then select the **OK** button. The Save As panel is displayed.
8. Specify the download destination, and then select the **Save** button. When the file is downloaded successfully, the Download Complete panel is displayed.

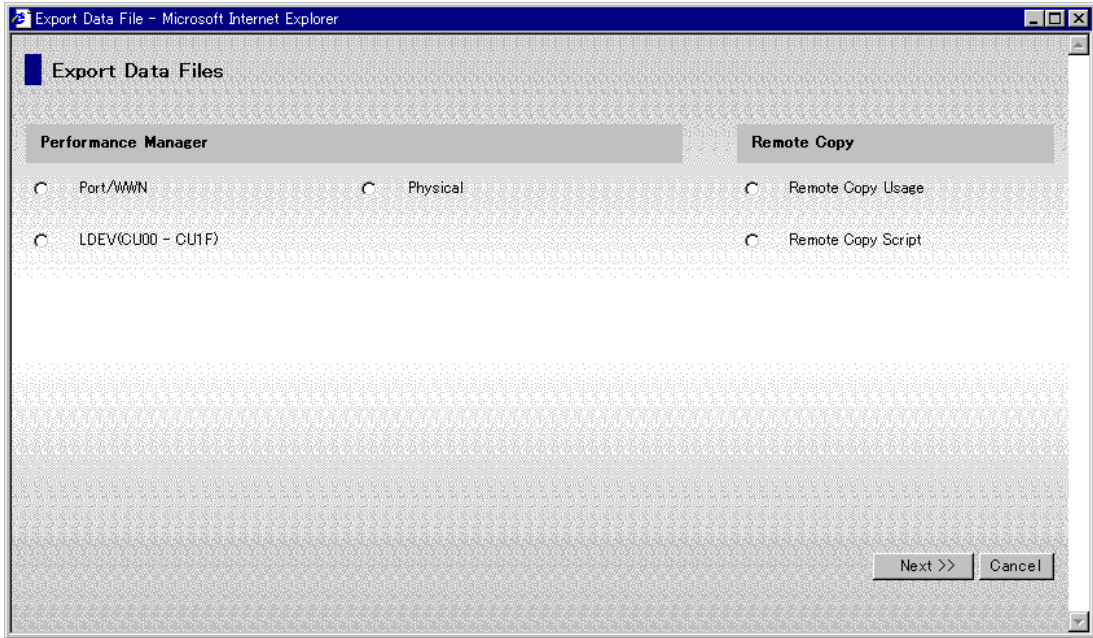

Figure 3.48 Export Data Files Panel (Selecting Data)

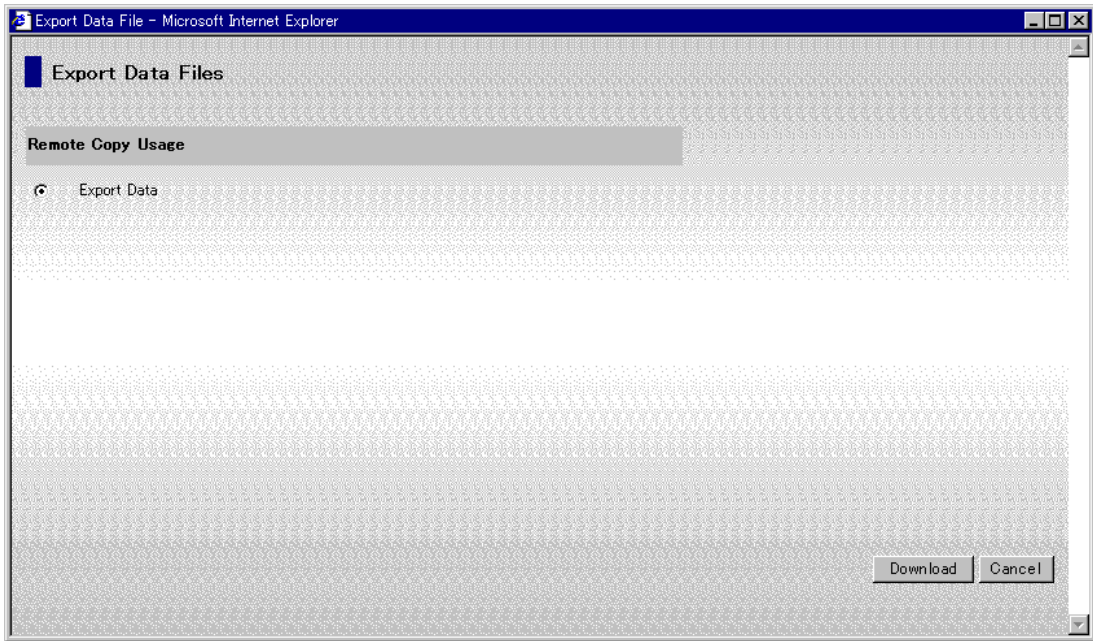

Figure 3.49 Export Data Files Panel (New Data)

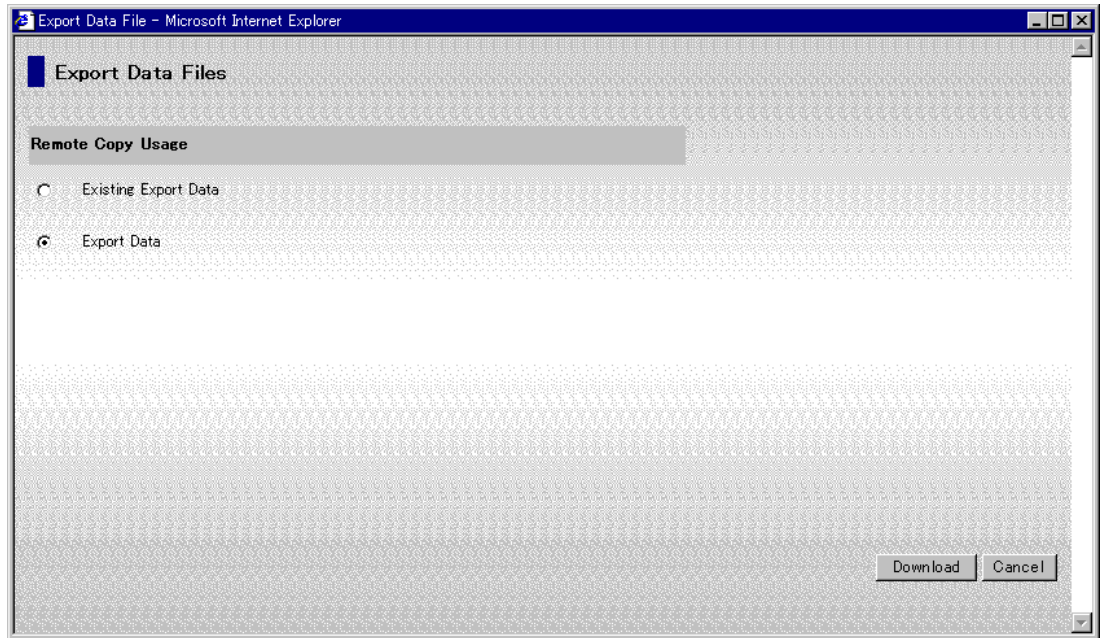



Figure 3.50 Export Data Files Panel (Export Data)

### 3.12 Uploading Files to SVP Using the FTP Client Function

The 9900V Remote Console supports the **FTP Client** function. The **FTP Client** function enables users to upload files from the Remote Console to the desired SVP. For example, the license key file for installing multiple options must be uploaded to the SVP prior to options installation. Also, script files used by Hitachi TrueCopy - S/390® must be downloaded before users can use the scripting function.

**Note:** Because of the Java™ applet program feature, the Web server cannot directly access data on the web client. Therefore, the **FTP Client** function is required to upload data from the Remote Console to the SVP.

To upload files to the SVP using the **FTP Client** function:

1. On the Remote Console Main panel, select the **FTP Client** button  to open the File Download (FTP Client) panel (see Figure 3.51).
2. Make one of the following selections:
  - Select the **FTP Client (jar file)** hyper link to download the **spfc-01\_00.jar** file onto a directory on the Remote Console. **Note:** If you use the **FTP Client** function from the SVP, you must save the file in the `C:\dkc200\tmp` directory.
  - Select the **FTP Client run batch for Win32** hyper link to download the **spfc\_win32.cmd** file onto the same directory that you specified in step 2.
3. Select the **Close** button.
4. Open the Windows® Explorer panel to display the downloaded files (see Figure 3.52).
5. Select the downloaded file to display the Upload panel. (see Figure 3.53). On the Upload panel, do the following:
  - In the **SVP IP Address** box, either enter the IP address of the SVP, or select the existing IP address from the list.
  - In the **File Name on Client** box, enter the full path name of the file to be uploaded, or select the file by using the **Reference** button (see Figure 3.54). You can enter up to 200 alphanumeric characters.
  - Select the **Upload** button.
6. When the file is uploaded, a confirmation message is displayed (see Figure 3.55).

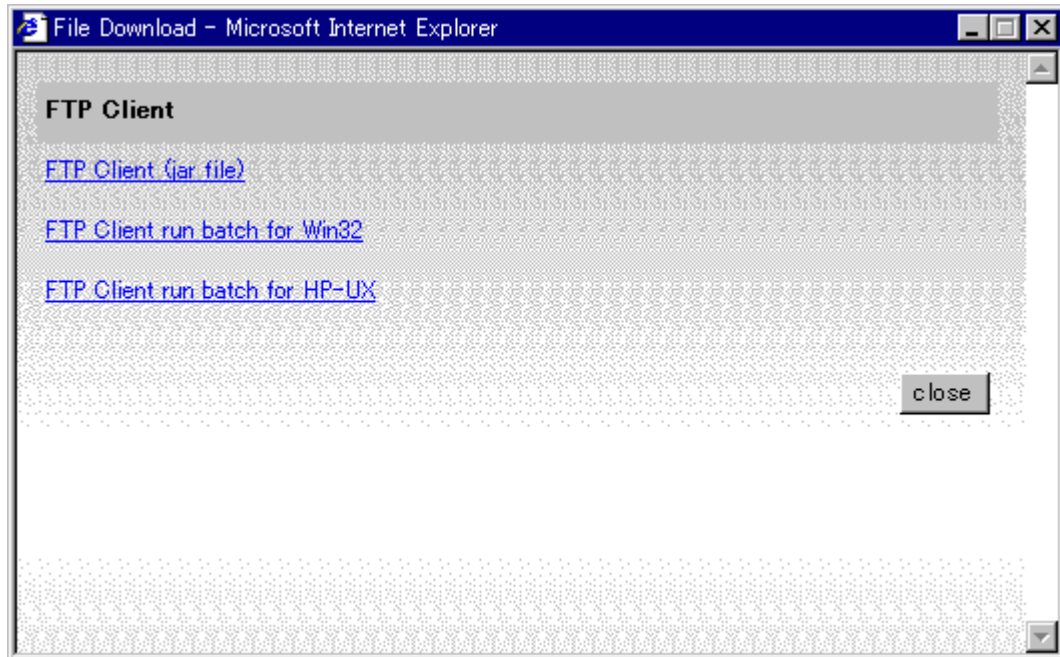

Figure 3.51 File Download (FTP Client) Panel

**Note:** HP-UX® download may not be supported in the initial release.

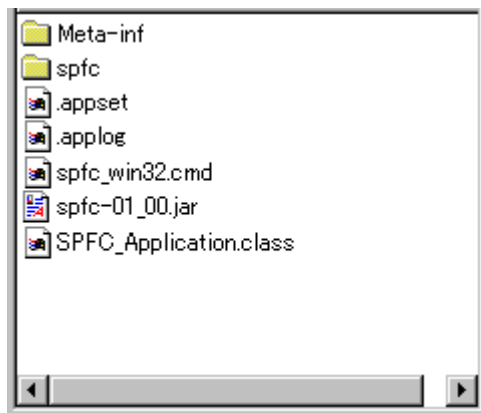

Figure 3.52 Sample Display on Windows® Explorer

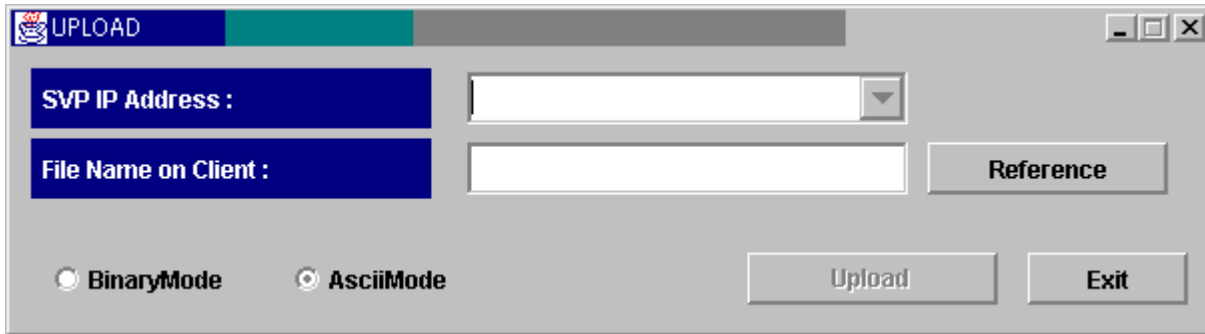

Figure 3.53 Upload Panel

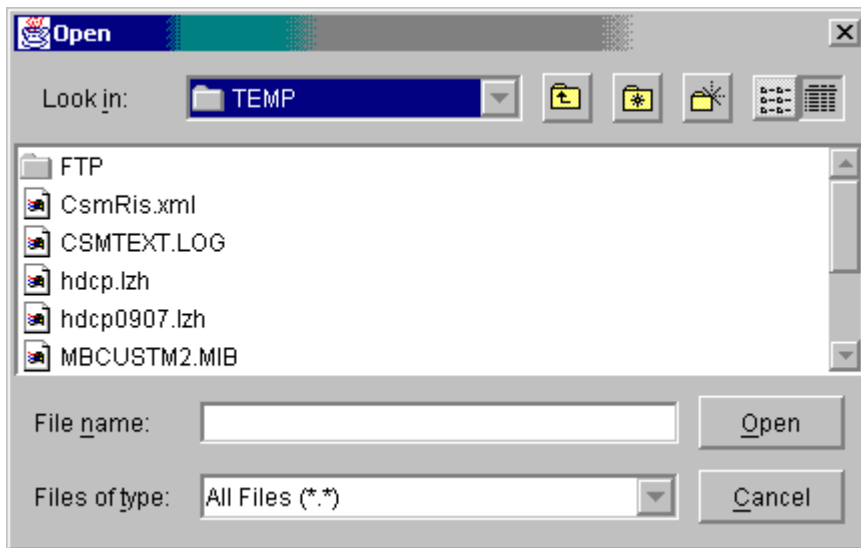

Figure 3.54 Open Panel by Reference Button

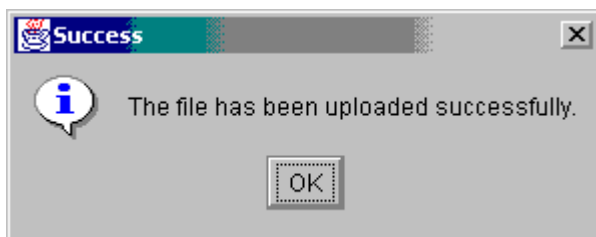

Figure 3.55 Success Panel



# Chapter 4 Setting SNMP Agent Properties

## 4.1 Overview of SNMP Agent Properties

**WARNING:** Before setting SNMP Agent properties, be sure that both the Hitachi SNMP API and the Microsoft SNMP agent are installed on the 9900V SVP, to allow the SNMP agent to run as a daemon program.

The Simple Network Management Protocol (SNMP) is an industry-standard method for storage and communication devices that is used to transfer status and management commands across TCP/IP networks. The SNMP agent (SNMP) performs error-reporting operations requested by the SNMP manager for 9900V subsystem(s). SNMP properties are usually set from the SVP, but you can also set the SNMP properties for the connected 9900V subsystem using the Remote Console. You can perform the following SNMP functions using the Remote Console:

- add and delete IP addresses of SNMP managers (see section 4.3.1),
- add, delete, and change communities (see section 4.3.3) and
- add, delete, and change IP addresses of communities (see section 4.3.6).

**Note:** To set the SNMP properties, you must register the SNMP system group information including the device name, contact information, and location of the subsystem to be managed on the **Information** tab of the Remote Console Main panel (refer to Figure 3.1).

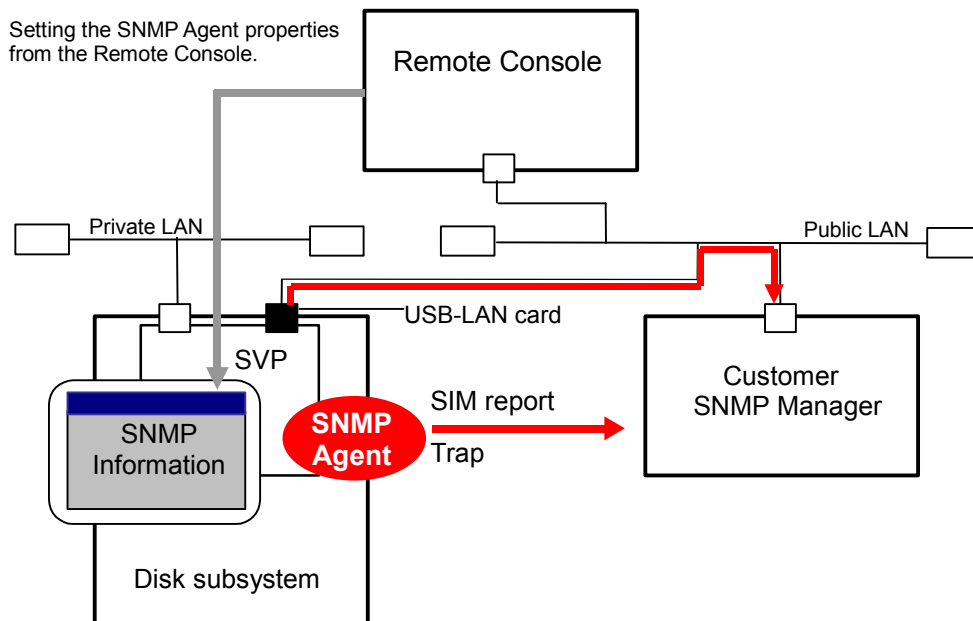

Figure 4.1 Illustration of 9900V SNMP Environment

## 4.2 The SNMP Information tab

The **SNMP Information** tab allows you to extend the number of LUs and cache memory using the Just In Time Storage functions. To open the **SNMP Information** tab, select the **License Key/SNMP/Just In Time** button (🌐) on the Remote Console Main panel (refer to Figure 3.1), and then select the **SNMP Information** tab (see Figure 4.2).

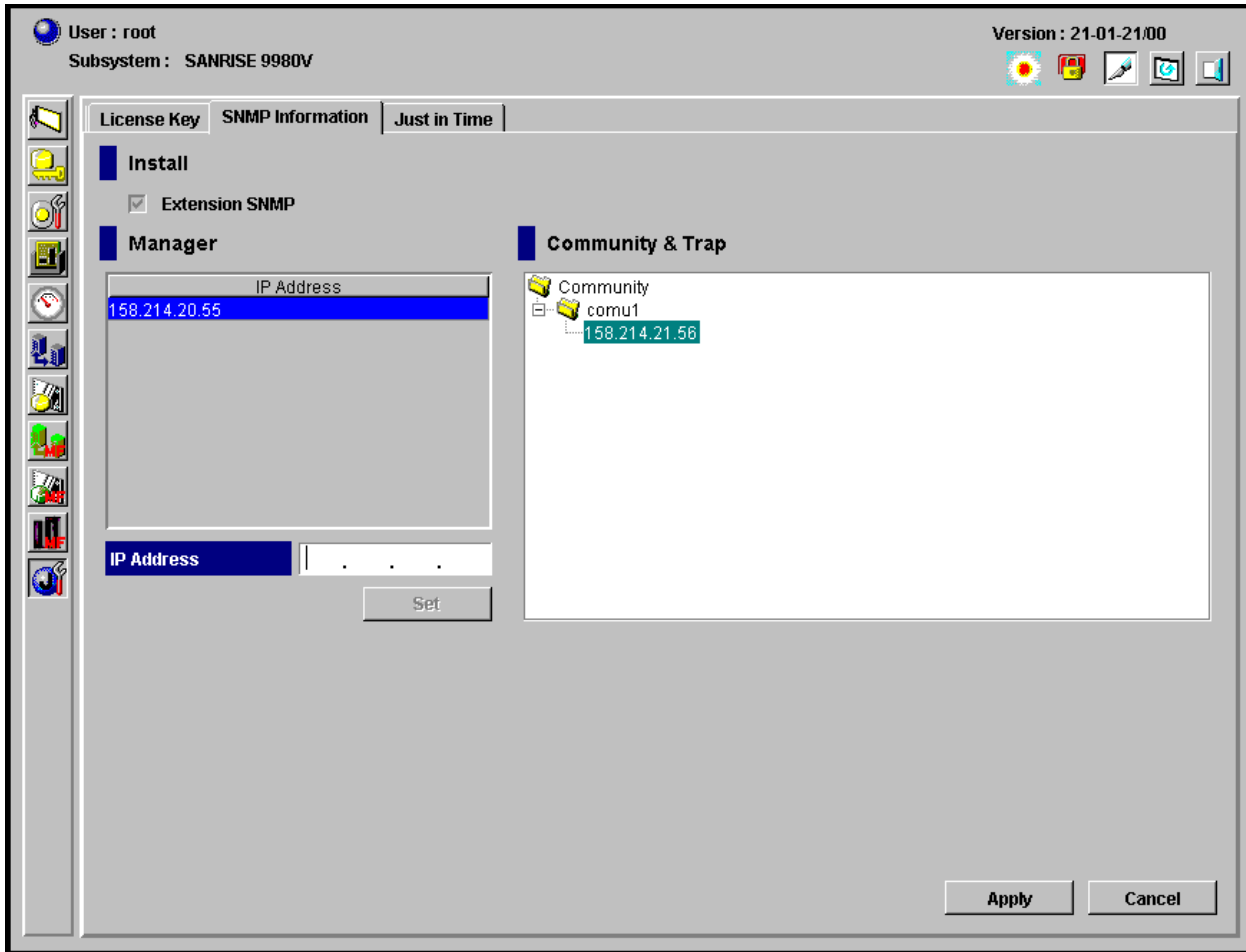

Figure 4.2 License Key/SNMP/Just in Time Panel, SNMP Information tab

The **SNMP Information** tab has the following features:

- The **Extension SNMP** checkbox is selected if the SNMP Agent feature is enabled. This must be selected in order for you to perform SNMP operations from the Remote Console. Note: This must be set from the SVP. Contact your Hitachi Data Systems account team for assistance.
- The **Manager** section allows you to add and delete SNMP manager information (see section 4.3.1 for instructions):
  - The **IP Address** list box displays the IP addresses of the registered SNMP managers from which the SNMP agent will accept requests. If no manager is registered, the SNMP agent accepts requests from all managers. You can register up to 32 managers.
  - The **IP Address** text box allows you to enter the IP address that you want to register as an SNMP manager. The value of each number in the IP address must be from 0 to 255 inclusive.
  - The **Set** button adds the new IP address to the **IP Address** list box.
- The **Community & Trap** section allows you to add, delete, or change SNMP trap information. The registered IP address is the trap destination for the specified community. Each community can have more than one defined IP address (see sections 4.3.3 and 4.3.6 for instructions). You can register up to 32 community names and up to 32 IP addresses per community name. You can use up to 180 alphanumeric characters for a community name.
- The **Apply** button implements the settings made on this panel.
- The **Cancel** button cancels the settings made the this panel.

## 4.3 SNMP Agent Operations

**Note:** To set the SNMP Agent properties from the Remote Console, you must select the **Extension SNMP** checkbox from the connected SVP. You must have the write permission to change the SNMP Agent properties.

### 4.3.1 Adding SNMP Manager IP Addresses

To add an SNMP manager IP address:

1. Change to **Modify** mode (refer to section 2.5 if you need instructions).
2. Select the **License Key/SNMP/Just in Time** button (🔑), then select the **SNMP Information** tab (refer to Figure 4.2).
3. In the **IP Address** text box, enter the desired numerical IP address (see Figure 4.3).
4. Select the **Set** button to add the new IP address. The new IP address is added to the **IP Address** list (see Figure 4.3), but the changes are not implemented until you select the **Apply** button (see below).
5. If you want to apply the changes to the subsystem, select **Apply** and then select **OK** on the confirmation message (refer to Figure 2.13).
6. If you want to cancel the changes and not apply them to the subsystem, select **Cancel** and then select **OK** on the confirmation message (refer to Figure 2.14).

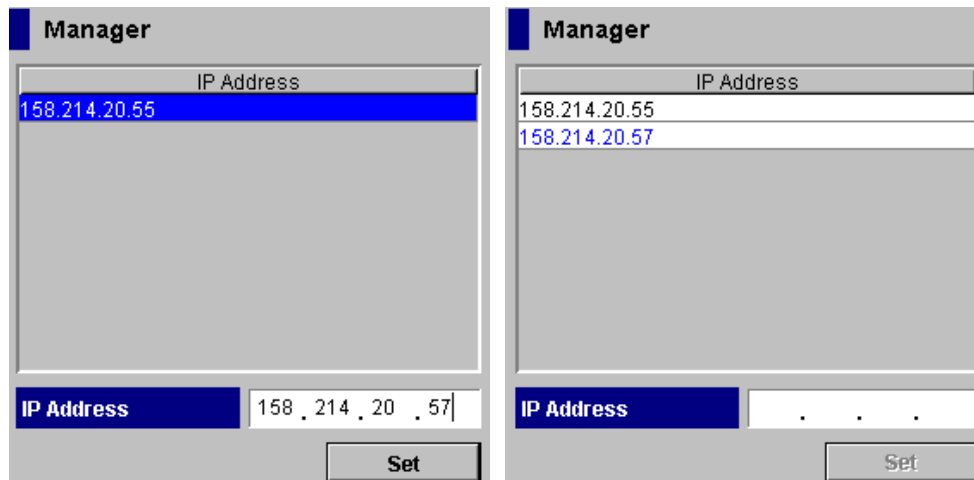

Figure 4.3 Setting IP Address (Right: Before Setting, Left: After Setting) (From the License Key/ Just in Time/SNMP Panel, SNMP Information tab)

### 4.3.2 Deleting SNMP Manager IP Addresses

To delete an SNMP manager IP address:

1. Change to **Modify** mode (refer to section 2.5 if you need instructions).
2. Select the **License Key/SNMP/Just in Time** button (🔑), then select the **SNMP Information** tab (refer to Figure 4.2).
3. Left click one or more unwanted IP addresses in the **IP Address** list box to select them, then right-click to display the **Delete IP Address** pop-up command (see Figure 4.4).
4. Select the **Delete IP Address** command.
5. A confirmation message is displayed. Select the **OK** button to delete, or select the **Cancel** button to cancel.
6. On the Remote Console Main panel, select the **Apply** button.
7. If you want to apply the changes to the subsystem, select **Apply** and then select **OK** on the confirmation message (refer to Figure 2.13).
8. If you want to cancel the changes and not apply them to the subsystem, select **Cancel** and then select **OK** on the confirmation message (refer to Figure 2.14).

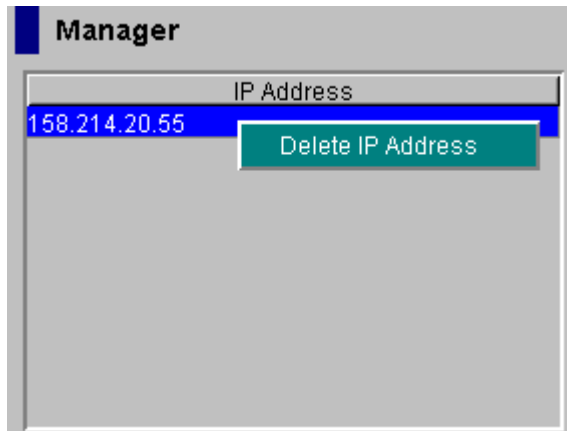

Figure 4.4 Delete IP Address Pop-Up Command

### 4.3.3 Adding A Community Name

To add a community name:

1. Change to **Modify** mode (refer to section 2.5 if you need instructions).
2. Select the **License Key/SNMP/Just in Time** button () , then select the **SNMP Information** tab (refer to Figure 4.2).
3. In the **Community &Trap** box, select and then right-click on **Community**. The **Add Community** pop-up menu is displayed (see Figure 4.5).
4. Select the **Add Community** command. The **Community** panel (see Figure 4.6) is displayed.
5. In the **Community** text box, enter a desired community name. **Note:** You can enter up to 180 alphanumeric characters for a community name.
6. Select the **OK** button. The new community name is displayed in the **Community & Trap** box, but the changes are not yet implemented in the subsystem.
7. If you want to add one or more IP addresses to the new community, refer to section 4.3.6.
8. If you want to apply the changes to the subsystem, select **Apply** and then select **OK** on the confirmation message (refer to Figure 2.13).
9. If you want to cancel the changes and not apply them to the subsystem, select **Cancel** and then select **OK** on the confirmation message (refer to Figure 2.14).



Figure 4.5 Add Community Pop-Up Menu

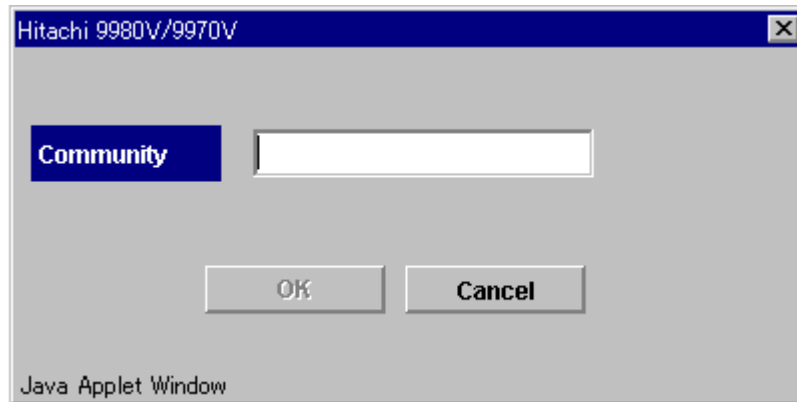

Figure 4.6 Add Community Panel

### 4.3.4 Deleting A Community Name

To delete a community name:

1. Change to **Modify** mode (refer to section 2.5 if you need instructions).
2. Select the **License Key/SNMP/Just in Time** button (🔑), then select the **SNMP Information** tab (refer to Figure 4.2).
3. In the **Community & Trap** box, select the unwanted community, and then right-select using the mouse. The **Delete Community** popup menu is displayed (see Figure 4.7).
4. Select the **Delete Community** command. A confirmation message is displayed.
5. Select the **OK** button to delete, or select the **Cancel** button to cancel. The selected community is deleted from the **Community & Trap** box, but the setting is not yet implemented in the subsystem.
6. If you want to apply the changes to the subsystem, select **Apply** and then select **OK** on the confirmation message (refer to Figure 2.13).
7. If you want to cancel the changes and not apply them to the subsystem, select **Cancel** and then select **OK** on the confirmation message (refer to Figure 2.14).



Figure 4.7 Community and Trap Popup Menu (Delete Community Selected)



### 4.3.5 Changing A Community Name

To change a community name:

1. Change to **Modify** mode (refer to section 2.5 if you need instructions).
2. Select the **License Key/SNMP/Just in Time** button () , then select the **SNMP Information** tab (refer to Figure 4.2).
3. Select the community name that you want to change in the **Community & Trap** box, right-select using the mouse. The **Change Community** popup menu is displayed (see Figure 4.8).
4. Select the **Change Community** command. The Change Community panel is displayed (see Figure 4.9).
5. In the **Community** text box, overwrite the old community name with a new community name. **Note:** You can enter up to 180 alphanumeric characters.
6. Select the **OK** button. The changed community name is displayed in the **Community & Trap** box, but the changes are not yet implemented in the subsystem.
7. If you want to apply the changes to the subsystem, select **Apply** and then select **OK** on the confirmation message (refer to Figure 2.13).
8. If you want to cancel the changes and not apply them to the subsystem, select **Cancel** and then select **OK** on the confirmation message (refer to Figure 2.14).

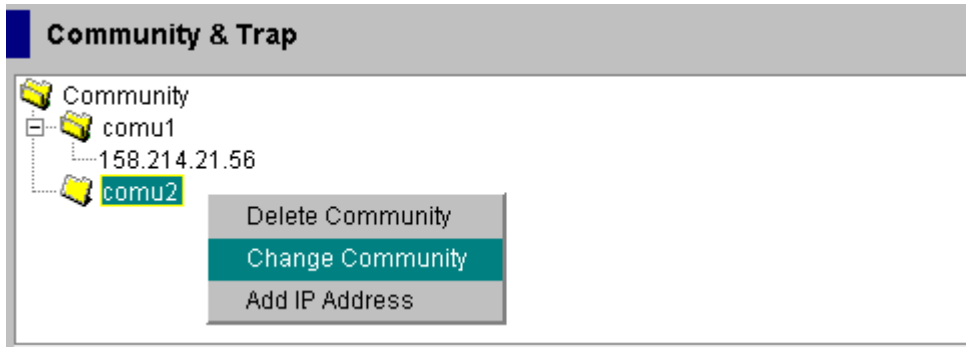

Figure 4.8 Change Community Pop-Up Menu

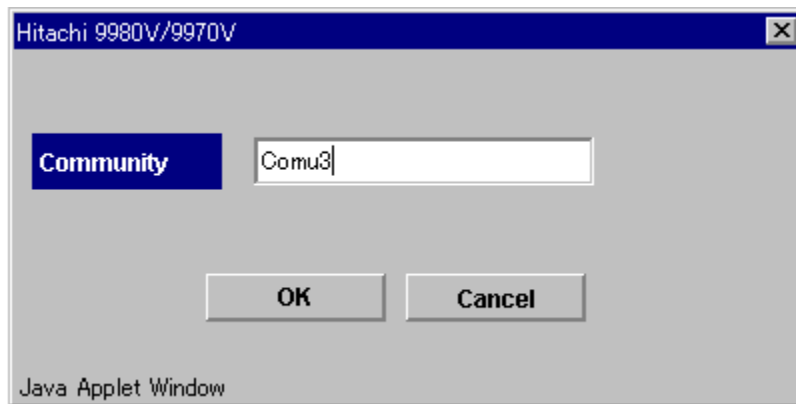

Figure 4.9 Change Community Panel

### 4.3.6 Adding Community IP Addresses

To add an IP address of a community:

1. Log on to open the Remote Console Main panel, select the **License Key/SNMP/Just in Time** button, and then select the **SNMP Information** tab. The **SNMP Information** panel is displayed (see Figure 4.2).
2. Select the desired community that you want to add an IP address in the **Community & Trap** box, right-select using the mouse. The popup menu is displayed (see Figure 4.10).
3. Select the **Add IP Address** command. The Add IP Address panel is displayed (see Figure 4.11).
4. In the **IP Address** box, enter a new IP address or select the existing IP address.
5. Select the **OK** button. The new IP address is displayed in the **Community & Trap** box, but the change is not yet implemented to the subsystem.
6. If you want to apply the changes to the subsystem, select **Apply** and then select **OK** on the confirmation message (refer to Figure 2.13).
7. If you want to cancel the changes and not apply them to the subsystem, select **Cancel** and then select **OK** on the confirmation message (refer to Figure 2.14).



Figure 4.10 Community and Trap Popup Menu (Add IP Address Selected)

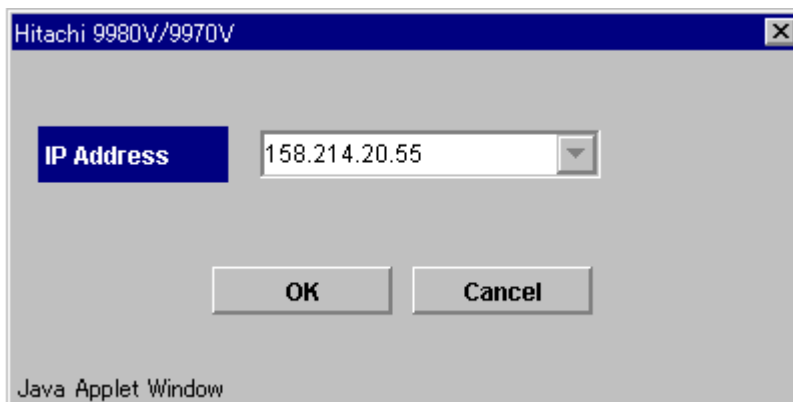

Figure 4.11 Add IP Address Panel

### 4.3.7 Deleting A Community IP Address

To delete an IP address of a community:

1. Change to **Modify** mode (refer to section 2.5 if you need instructions).
2. Select the **License Key/SNMP/Just in Time** button (🔑), then select the **SNMP Information** tab (refer to Figure 4.2).
3. In the **Community & Trap** box, select the unwanted community IP address, and then right-select using the mouse. The **Delete IP Address** pop-up menu is displayed (see Figure 4.12).
4. Select the **Delete IP Address** command. A confirmation message is displayed.
5. Select the **OK** button to delete, or select the **Cancel** button to cancel. The selected IP address is deleted from the **Community & Trap** box, but the change is not yet implemented on the subsystem.
6. If you want to apply the changes to the subsystem, select **Apply** and then select **OK** on the confirmation message (refer to Figure 2.13).
7. If you want to cancel the changes and not apply them to the subsystem, select **Cancel** and then select **OK** on the confirmation message (refer to Figure 2.14).



Figure 4.12 Delete IP Address Pop-Up Menu

# Chapter 5 Troubleshooting

## 5.1 Troubleshooting

- For troubleshooting information on the 9900V subsystem, please refer to the *Hitachi Freedom Storage™ Lightning 9900™ V Series User and Reference Guide* (MK-92RD100).
- For information on the 9900V Remote Console software error codes, please refer to the *Hitachi Freedom Storage™ Lightning 9900™ V Series Hitachi Remote Console - Storage Navigator Error Codes* (MK-92RD132).

The user is responsible for the operation and normal maintenance of the PC(s) that host the 9900V Remote Console software. Here are some guidelines for troubleshooting 9900V Remote Console software operations:

- **Check the cabling and the LAN.** Verify that both the computer and LAN cabling are firmly attached, and that the LAN is operating properly.
- **Reboot the PC.** Close any programs that are not responding. If necessary, reboot the PC and restart the 9900V Remote Console - Storage Navigator Java™ applet program.
- **Check for any General Error Conditions.** Check the troubleshooting information in the *Hitachi Lightning 9900V Hitachi Remote Console - Storage Navigator User's Guide*. The document lists general error conditions and provides recommended resolution for each condition. If you are still unable to resolve an error condition, please call the Hitachi Data Systems Support Center for assistance (see section 5.2 for contact information).
- **Check the status lamp on the Remote Console Main Panel (Status Tab).** If the lamp becomes yellow (🟡) or red (🔴), confirm the severity level of the error on the Status panel. If you are unable to resolve an error condition, please contact the Hitachi Data Systems Support Center (see section 5.2).
- **Download the Remote Console trace files using the FD Dump Tool.** If you are unable to resolve an error condition, copy the 9900V Remote Console configuration information onto diskette using the FD Dump Tool (see section 3.10 for instructions). Contact the Hitachi Data Systems Support Center (see section 5.2), and give this information on the floppy disk(s) to the Hitachi Data Systems service personnel.

**Table 5.1 General Error Conditions**

Error Condition	Probable Cause / Recommended Action
<b>Application Error</b>	
The Remote Console experiences an error.	Save the Java™ log file on the Remote Console, and report to the Hitachi Data Systems Technical Support Center. For Windows® 2000, the Java™ log file is in the following place: c:\Documents and Settings\login user ID\plugin131.trace Restart the Remote Console.
Only the Exit and Refresh buttons are effective when accessing the SVP from the Remote Console.	The SVP might not be ready or perform some write processes from the other system. Wait for a while, and then select the <b>Refresh</b> button.
<b>Abnormal End / No Response</b>	
An internal error occurs, or a web browser ends abnormally (forcibly).	Close all panels (including the Storage Device List panel), and then log on to the Remote Console again. If the same error occurs, restart the Remote Console.
A network error occurred. There is no response to an operation even after 30 minutes passed.	Restart the Remote Console.
<b>Incorrect Display/ Disoperation</b>	
After dragging and dropping objects to another location or area, the scroll bar on that location becomes unusable.	Close all panels including the Storage Device List panel, and then log on to the Remote Console again.
A focus disappears from the edit box.	Close all panels including the Storage Device List panel, and then log on to the Remote Console again.
The display of the web browser becomes incorrect, because some GUI items such as labels and icons cannot be downloaded properly.	Log off from the Remote Console and then re-log in.
A Remote Console panel is closed by: – Selecting the <input type="checkbox"/> button on the panel, – Using the commands such as <b>File</b> and <b>Exit</b> on the web browser, or – Pressing the <b>Alt</b> and <b>F4</b> keys.	Wait for an RMI™ time-out (default is 1 min.), and then restart the Remote Console.
<b>Maintenance / Others</b>	
The program on the SVP is updated.	Exit all web browsers on the Remote Console, and then restart the browsers. If in doubt, you should exit and restart the browsers.
The time of the clock on the Remote Console is reset.	Clear cache (the existing temporary Internet files) of the web browser before logging on to the Remote Console.
Remote Console processing is temporarily delayed.	An internal processing (e.g., configuration change, Program Product. check, operational information acquisition, etc.) might be being executed on the SVP (web server).
If you are unable to resolve an error condition.	Copy the 9900V Remote Console configuration information onto floppy disk(s) using the <b>FD Dump Tool</b> (refer to section 3.10), and contact the Hitachi Data Systems Technical Support Center (see section 5.2).

## 5.2 Calling the Hitachi Data Systems Technical Support Center

If you need to call the Hitachi Data Systems Technical Support Center, be sure to provide as much information about the problem as possible. Include the circumstances surrounding the error or failure, the 9900V Remote Console configuration information saved in the floppy diskette(s) by the **FD Dump Tool**, the exact content of any messages displayed on the Remote Console, and the severity levels and reference codes displayed on the **Status** tab of the Remote Console Main panel (refer to Figure 3.6). The worldwide Hitachi Data Systems Technical Support Centers are:

- Hitachi Data Systems North America/Latin America  
San Diego, California, USA  
1-800-348-4357
- Hitachi Data Systems Europe  
Contact Hitachi Data Systems Local Support
- Hitachi Data Systems Asia Pacific  
North Ryde, Australia  
011-61-2-9325-3300





## Glossary, Acronyms, and Abbreviations

Command Control Interface (CCI)	System administrators can enter Command Control Interface (CCI) commands from open-system hosts to perform Hitachi TrueCopy and ShadowImage operations on logical devices.
CruiseControl	CruiseControl performs automatic relocation of volumes to optimize performance.
CU	Control Unit. The 9900V subsystem supports a maximum of 16 logical control unit (CU) images, numbered sequentially from 0 to F. Each CU image controls up to 256 LDEVs.
Custom Access	A feature that allows a non-administrator to be assigned write access to one or more of the restricted Remote Console functions. See section 3.3.
DASD	Direct-Access Storage Device
DKC	Disk Controller. The 9900V disk controller provides up to sixteen logical control unit (CU) images and supports 3990-6, 3990-6E, 2105-F20, OPEN-E, OPEN-9 and OPEN-L disk controller emulation.
DKU	Disk Array Unit. The 9900V subsystem has up to six disk array frames containing the storage components (disk drive arrays) of the subsystem.
ESCON®	Enterprise System Connection
Export File	The Export File function allows you to export data (e.g., monitoring data used by Performance Monitor or Hitachi TrueCopy) to data files. See section 3.11.
FD	floppy disk
FD Dump Tool	This function downloads the 9900V Remote Console configuration information onto a floppy diskette or a hard disk drive, and is generally used for troubleshooting purposes.
FICON™	Fibre Connection
FlashAccess	FlashAccess (Dynamic Cache Residence) enables you to store specific high-usage data directly in cache memory to provide virtually immediate data availability.
GB	gigabyte(s)
Hi-Star™	Hierarchical Star Network architecture improves the total performance of internal data transfer by using high-speed crossbar switches.
HMBR	Hitachi Multiplatform Backup/Restore
Java™ applet program	The web client Java™ applet program runs on a web browser on the Remote Console. When a Remote Console user accesses and logs on to the desired SVP, the web client Java™ applet is downloaded from the SVP to the Remote Console. The web client Java™ applet program runs on a web browser on the Remote Console.
JVM™	Java Virtual Machine™ is the web client Java™ applet program that is installed in each SVP and runs using web browsers to provide a user-friendly interface for the 9900V Remote Console functions.

kB	kilobyte(s)
LAN	local-area network
LBA	logical block address
LDEV	logical device. An LDEV used by mainframe hosts can be called a device, logical volume image (LVI) or a volume. An LDEV used by open-system hosts is called a logical unit (LU).
LU	An LDEV used by open-system hosts is called a logical unit (LU). Open-system fibre interfaces access LUs that are mapped to one or more LDEVs.
LUN	logical unit number is an identifying number for an LU.
LUN Manager	Remote Console software option. This option must be installed before you can install LUSE, Hitachi SANTinel, or Extended Copy Manager *** <b>(Is this still true?)</b> . LUN Manager enables you to configure the 9900V fibre-channel ports for operational environments, and restrict host access to LUs.
LUSE	LUN Expansion. This function allows you to concatenate two or more volumes into a larger volume.
LVI	Logical Volume Image (also called device emulation)
MB	megabyte(s)
MIB	message information block
Open Volume Management	A suite of options that includes Virtual LVI/LUN and LUSE (LUN Expansion). Virtual LVI/LUN divides a logical volume for open-system into two or more volumes. LUN Expansion allows you to concatenate two or more volumes into a larger volume.
Parity group	A set of hard disk drives that have the same capacity and are treated as one group. A parity group contains both user data and parity information, which allows the user data to be accessed in the event that one or more of the drives within the group are not available.
Performance Maximizer	An option that includes Performance Monitor, CruiseControl, and Priority Access. The Performance Monitor option monitors subsystem and volume activity, and the Hitachi CruiseControl option performs automatic relocation of volumes to optimize performance, and Priority Access***
RMI™	Remote Method Invocation. RMI™ is a remote procedure call, which allows Java™ objects stored in the network to be run remotely.
R-SIM	remote service information message (generated by the 9900Vwhen it detects an error or service requirement).
SIM	service information message (generated by a subsystem when it detects an error or service requirement).
ShadowImage	An option that allows you to maintain subsystem-internal copies of all user data for purposes such as data backup and duplication.
SNMP	simple network management protocol (part of the TCP/IP protocol suite)
SSID	storage subsystem ID. The 9900Vis configured with one SSID for each 64 devices, and up to four SSIDs for each CU image.
SVP	Service Processor (this is the notebook computer that is inside the RAID450).
TCP/IP	transmission control protocol/internet protocol

TID	target ID
Trap	An SNMP agent initiates trap operations when R-SIMs occur, in order to send the R-SIMs to the SNMP manager (see Figure 4.1). An SNMP agent can be configured to deliver traps to more than one SNMP manager.
TrueCopy	TrueCopy is an option product that allows you to perform host-free remote copy operations between 9900V subsystems in different locations for data backup and disaster recovery purposes.
UCB	unit control block
User account list	The user account list includes user information such as user ID, password, and write permission for each 9900V option.
VIR	Virtual LVI/ LUN is an option that enables you to configure custom-size logical device images and logical units, which are smaller than standard-size devices.
Volser	volume serial number (mainframe volume identifier, not related to the LDEV ID)
Remote Console	The Remote Console communicates directly with the service processor (SVP) of each attached subsystem to obtain subsystem configuration and status information and send user-requested commands to the subsystem.
WWN	Worldwide Name, which is a unique identifier for a particular open-system host bus adapter, consisting of a 64-bit physical address (the IEEE 48-bit format with 12-bit extension and 4-bit prefix).
WWN Group	A WWN group gives every host in the specified WWN group access to a specified LU or group of LUs. This is part of the Hitachi SAnTinel feature.

