

Storage Racking

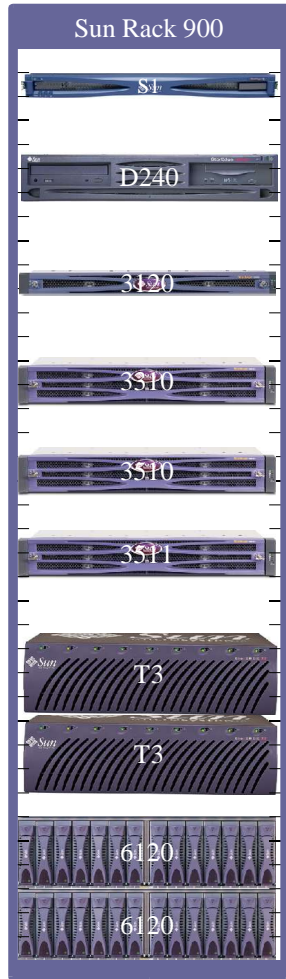

- S1**
3x 146 GB Disks
- D240 Media Tray**
2 x 146 GB disks
DVD, DDS-4 Tape Drive
- 3120**
4x 146 GB Disks
- 3310**
12x 146 GB Disks
- 3510**
12x 146 GB Disks
- 3511**
12x 250 GB Disks
- T3 Partner Pair**
18x 73 GB Disks
1.3 TB
2 GB Cache
- 6120 Array Set**
28x 146 GB Disks
4 TB
2 GB Cache



- L8 Tape Library**
1 Drive, 8 Cartridges
- L25 Tape Library**
2 Drives, 25 Cartridges
- L100 Tape Library**
6 Drives, 88 Cartridges
or 5 Drives, 100 Cartridges

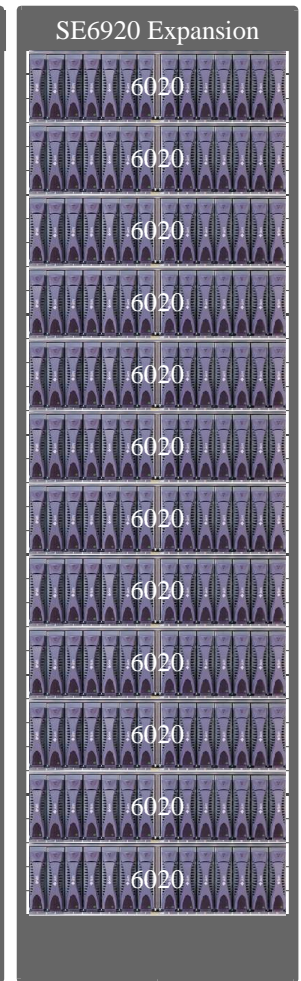
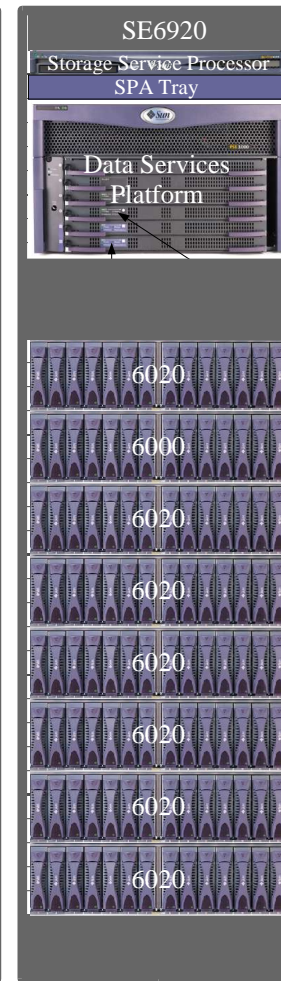
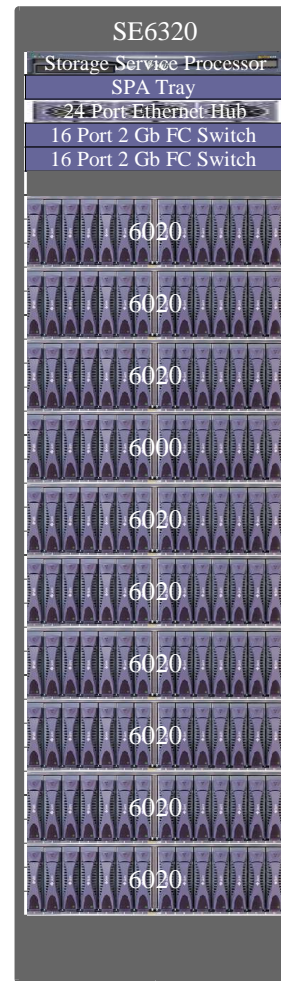

Disk Storage



S1
3 146 GB LVD Disks



3310
12 146 GB LVD Disks



D240
DVD
2 73 GB Disks
DDS-4 Tape



3510
12 146 GB FC Disks
2 GB Cache



3120
4 146 GB U320 Disks



3511
12 250 GB FC SATA Disks
2 GB Cache



6120 Array
28 146 GB FC Disks
4 TB
2 GB Cache



6320
11 6120 Arrays
Dual 16 port 2 GB Switches
1 Service Processor
45 TB
22 GB Cache



6920
16 6120 Arrays
Data Services Platform
1 Service Processor
64 TB
32 GB Cache



9970
128 Disks, 18 TB
48 Host interfaces
32 GB cache



9980
1024 Disks, 147 TB
64 Host interfaces
64 GB cache



S1 Disk Array

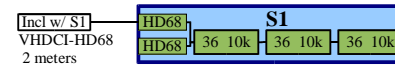

S1 Disk Array

2 or 3 36, 73, or 146 GB LVD SCSI disks

Will also operate as SCSI-2

1 Rack Unit

Rack Mount Kits:

X6919A: Rack Mount Kit for Sun 900 Rack & Sun 72" Cab

X6920A: Sun Fire Cabinet Rack Mount Kit

Ships with:

Incl w/ S1	Incl w/ S1
HD68-HD68	VHDCI-HD68
2 meters	2 meters

Disk Options

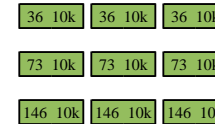

D240 Media Tray

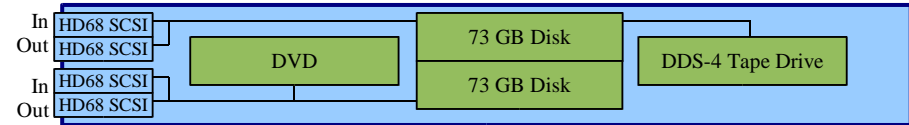

D240 Media Tray

DVD

2 x 73 GB disks

DDS-4 Tape Drive

-or-

DVD

3 x 73 GB disks -or-

-or-

4 x 73 GB disks

Features:

N+1 Power & Fans

Hot Swappable Power & Fans

Dual power cords

Dual or Single Ultra SCSI connections

2 Rack Units (3.5 in.) high

Rack Mount Kits:

Included: Sun 72" Cab & Sun Fire Cab

X6839A: Sun Rack 900 Mount Kit

Configuration Options

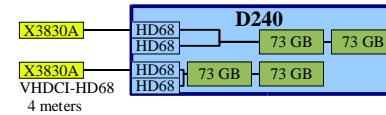
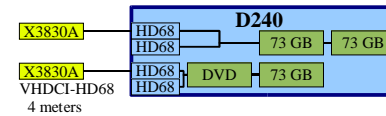
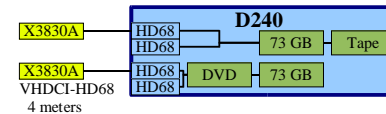

StorEdge 3120 Array



StorEdge 3120 SCSI Array

2, 3, or 4 Ultra320 SCSI Disks: 36GB 15K,
73GB 10K, 73GB 15K, 146GB 10K

Configurable to single or dual busses

Supports 1 or 2 hosts

N+1 Power & Fans

Dual power cords

1 Rack Units (1.75 in) high

JBOD only array

Can not be daisy chained

Qualified as boot device for V1280, E2900, F4800,
E4900, F6800 and E6900

Rackmount Kit for Sun Rack 900 & Sun 72" Cabinet :

XTA-30001URK-19U

Sun Fire Cabinet support later.

Host Bus Adapters:

6758A Dual LVD SCSI	VHDCI VHDCI
---------------------	----------------

2222A	10/100 Enet Dual RJ45's LVD SCSI Dual VHDCI's
-------	--

4422A	10/100/1000 Enet RJ45's SE/LVD SCSI VHDCI's
-------	--

9265A U320 SCSI	VHDCI VHDCI
-----------------	----------------

V20z only

Cables:

X1136A VHDCI-VHDCI 0.8 meter	X1137A VHDCI-VHDCI 1.2 meters	X1138A VHDCI-VHDCI 2 meters
---	--	--

X3830B VHDCI-VHDCI 4 meters	X3831B VHDCI-VHDCI 10 meters
--	---

JBOD Array Configurations

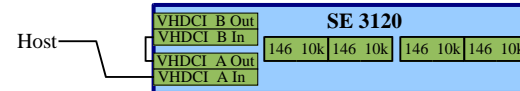

1 Host, Single Bus

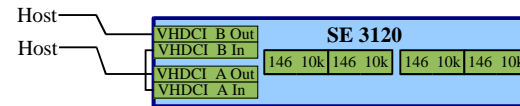

2 Host Connections, Single Bus

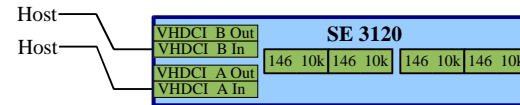

2 Host Connections, Dual Bus

Disk Options

36 15k	36 15k	36 15k	36 15k
--------	--------	--------	--------

73 10k	73 10k	73 10k	73 10k
--------	--------	--------	--------

73 15k	73 15k	73 15k	73 15k
--------	--------	--------	--------

146 10k	146 10k	146 10k	146 10k
---------	---------	---------	---------



StorEdge 3310 SCSI Array



StorEdge 3310 SCSI Array

5-12 LVD SCSI Disks: 36GB 10K, 36GB 15K,
73GB 10K, 73GB 15K, 146GB 10K
5 TB raw disk total(RAID & 2 JBOD arrays)
Configurable to single or dual busses
N+1 Power & Fans
Dual power cords
2 Rack Units (3.5 in) high

RAID Array:

Up to 2 H/W Raid Controllers
512 MB cache for each controller
Built-in Battery

JBOD Array

Use as standalone or as expansion
to a RAID Array.
Raid Controllers can NOT be added to
JBOD Arrays

Rackmount Kit:

XTA-3000-2URK-19U

Host Bus Adapter:

6758A Dual LVD SCSI VHDCl VHDCl

Cables:

X1136A VHDCl-VHDCl 0.8 meter
X1137A VHDCl-VHDCl 1.2 meters
X1138A VHDCl-VHDCl 2 meters

X3830B VHDCl-VHDCl 4 meters
X3831B VHDCl-VHDCl 10 meters

RAID Array Configurations

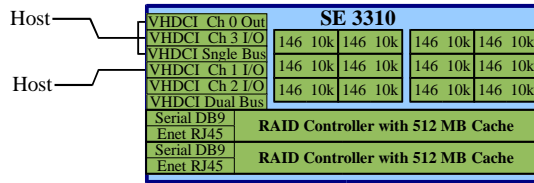

1 or 2 Host Connections, Single Bus

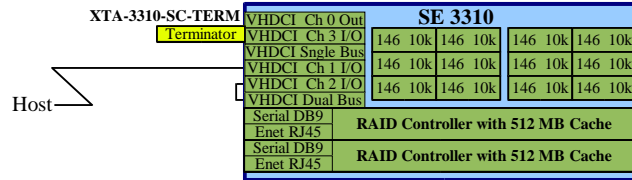

1 Host Connection, Dual Bus

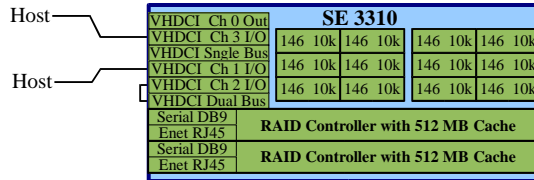

2 Host Connections, Dual Bus

JBOD Array Configurations

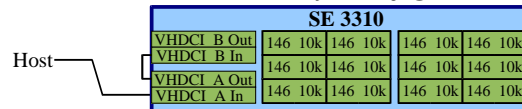

1 Host, Single Bus

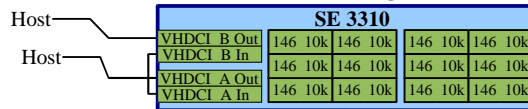

2 Host Connections, Single Bus

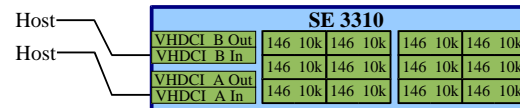

2 Host Connections, Dual Bus

RAID Array Sets

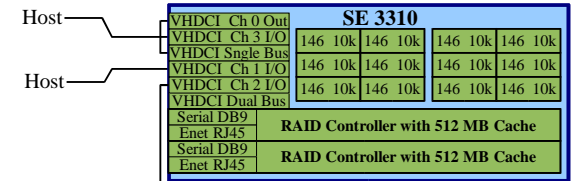

1 or 2 Host Connections
each array on separate Bus

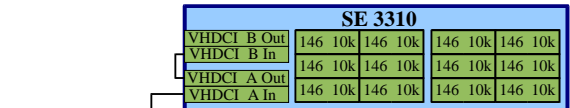

1 Host Connection
each array on separate Bus

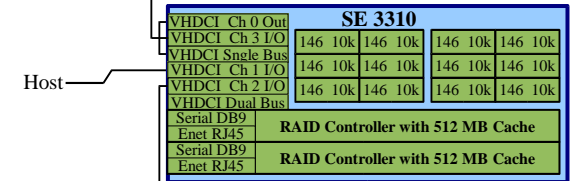

Disk Options

36 15k	36 15k	36 15k	36 15k
36 15k	36 15k	36 15k	36 15k
36 15k	36 15k	36 15k	36 15k

73 10k	73 10k	73 10k	73 10k
73 10k	73 10k	73 10k	73 10k
73 10k	73 10k	73 10k	73 10k

73 15k	73 15k	73 15k	73 15k
73 15k	73 15k	73 15k	73 15k
73 15k	73 15k	73 15k	73 15k

146 10k	146 10k	146 10k	146 10k
146 10k	146 10k	146 10k	146 10k
146 10k	146 10k	146 10k	146 10k



StorEdge 3510 Fibre Channel Array



StorEdge 3510 Fibre Channel Array
 5x-12x 36, 73, or 146 GB FC Disks
 5.1 TB max raw disk total (1 RAID & 2 JBOD Arrays)
 N+1 Power & Fans
 Dual power cords
 2 Rack Units (3.5 in) high

RAID Array:
 Up to 2 H/W Raid Controllers
 1 GB cache for each controller
 Built-in Battery Backup

JBOD Array:
 Use as standalone or as expansion to a RAID Array.
 Raid Controllers can be added to JBOD Arrays.

Rackmount Kit:
 XTA-3000-2URK-19U

Host Bus Adapters:

SG-XPCI1FC-QF2	2Gb FC	LC
SG-XPCI2FC-QF2	2Gb FC	LC

Cables:

X9732A	X9733A	X9734A	X9736A	X9738A
LC-LC fibre	LC-LC fibre	LC-LC fibre	LC-LC fibre	LC-LC fibre
2 meters	5 meters	15 meters	25 meters	50 meters

SFP:

LC SFP	XSFP-SW-2GB
--------	-------------

36 15k	36 15k	36 15k	36 15k
36 15k	36 15k	36 15k	36 15k
36 15k	36 15k	36 15k	36 15k

73 10k	73 10k	73 10k	73 10k
73 10k	73 10k	73 10k	73 10k
73 10k	73 10k	73 10k	73 10k

73 15k	73 15k	73 15k	73 15k
73 15k	73 15k	73 15k	73 15k
73 15k	73 15k	73 15k	73 15k

146 10k	146 10k	146 10k	146 10k
146 10k	146 10k	146 10k	146 10k
146 10k	146 10k	146 10k	146 10k

RAID Array Configuration

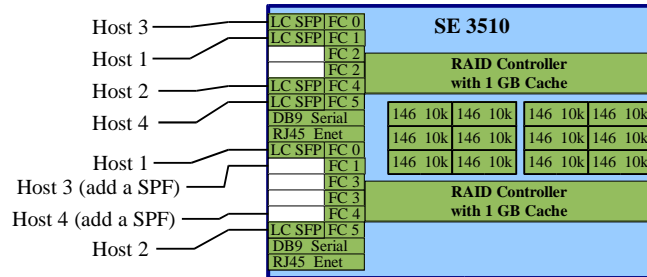

Dual RAID Controllers
 8 single host connections or
 4 redundant host connections

Single RAID Controller is supported
 4 single host connections

JBOD Array Configurations

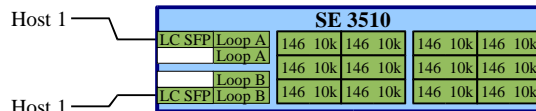

2 single host connections or
 1 redundant host connection

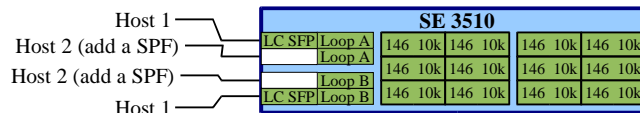

2 redundant host connections

RAID Array Sets

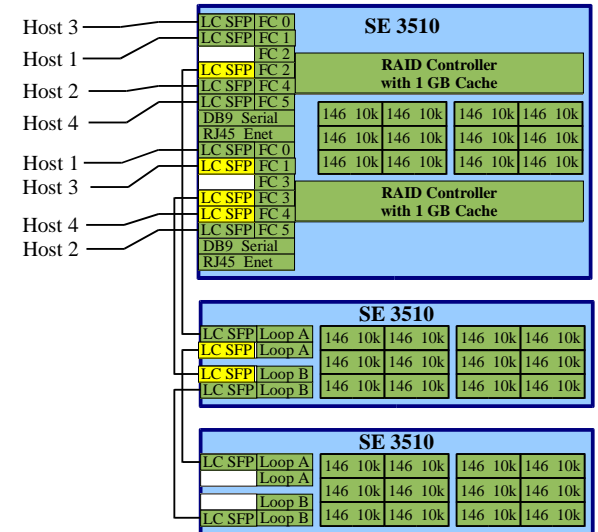

Dual RAID Controller
 8 single host connections or
 4 redundant host connections
 Dual JBOD Arrays

Single RAID Controller is supported
 4 single host connections

Single JBOD Array is supported

Disk Options



StorEdge 3511 Fibre Channel Array



StorEdge 3511 FC Array
 5x-12x 250 GB FC SATA Disks
 18 TB max raw disk total (1 RAID & 5 JBOD Arrays)
 N+1 Power & Fans
 Dual power cords
 2 Rack Units (3.5 in) high

RAID Array:
 Up to 2 H/W Raid Controllers
 1 GB cache for each controller
 Built-in Battery Backup

JBOD Array:
 Expansion to a RAID Array.
 Not supported as stand alone

Rackmount Kit:
 XTA-3000-2URK-19U

Host Bus Adapters:

SG-XPCI1FC-QF2 2Gb FC LC

SG-XPCI2FC-QF2 2Gb FC LC

Cables:

X9732A LC-LC fibre 2 meters
 X9733A LC-LC fibre 5 meters
 X9734A LC-LC fibre 15 meters
 X9736A LC-LC fibre 25 meters
 X9738A LC-LC fibre 50 meters

SFP:

LC SFP XSFP-SW-2GB

RAID Array Configuration

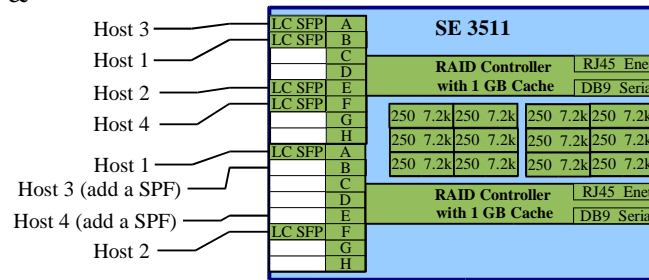

Dual RAID Controllers
 8 single host connections or
 4 redundant host connections

Single RAID Controller is supported
 4 single host connections

RAID Array Set

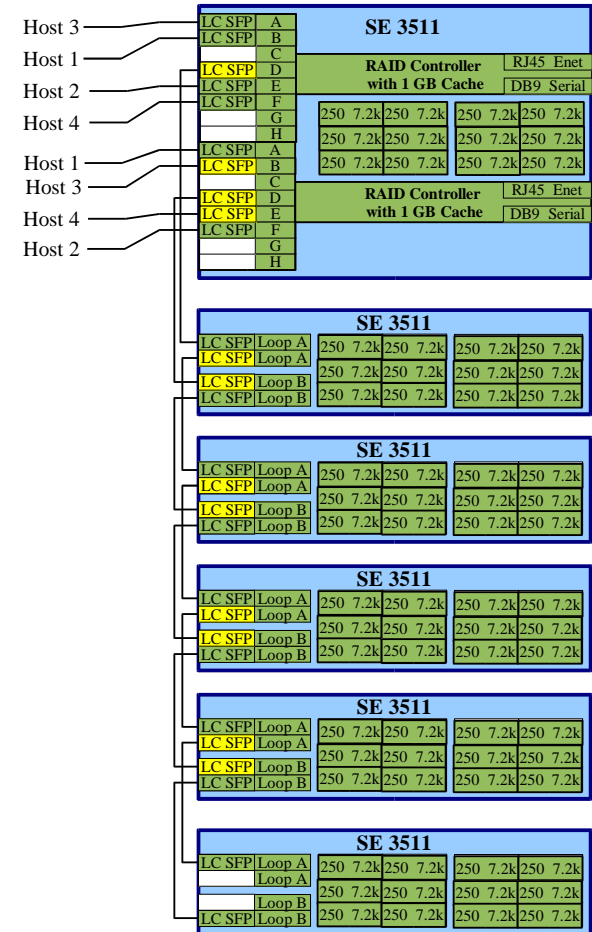

6120 Array

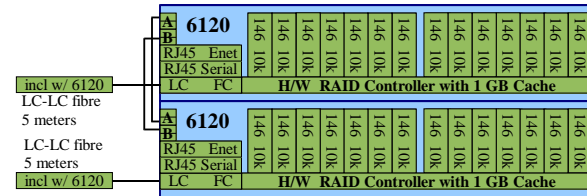

6120 Array Set
4 TB Disk, 2 GB cache

StorEdge 6120 Array

- 7-14 36, 73, or 146 GB FC Disks per tray
- 12 TB max raw disk total (2 RAID & 4 Expansion Trays)
- N+1 Power & Fans
- Dual power cords
- 3 Rack Units (3.5 in) high each tray

RAID Array:

- H/W Raid Controller
- 1 GB cache
- Built-in Battery Backup

Expansion Array:

- Use as expansion to a RAID Array.
- Raid Controllers can be added to Expansion Arrays.

Rack Mount Kit:

- X6876A For Sun Rack 900
- X6886A For 72" Cabinet, and SunFire Cabinet:

Ships with:

- 5 meter LC-LC cable
- 6 meter RJ45-RJ45 Enet cable

Disk Options

7 to 14 disks per tray



Hot Spare Location



StorEdge 6320

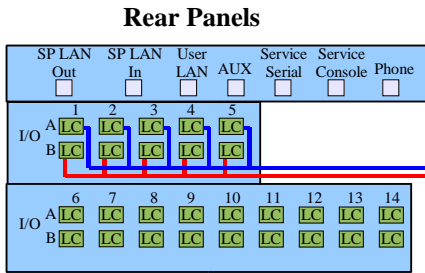

SE6320
 22 6020 Trays
 2 16-port 2GB Switches
 1 Service Processor
 45 TB
 22 GB Cache

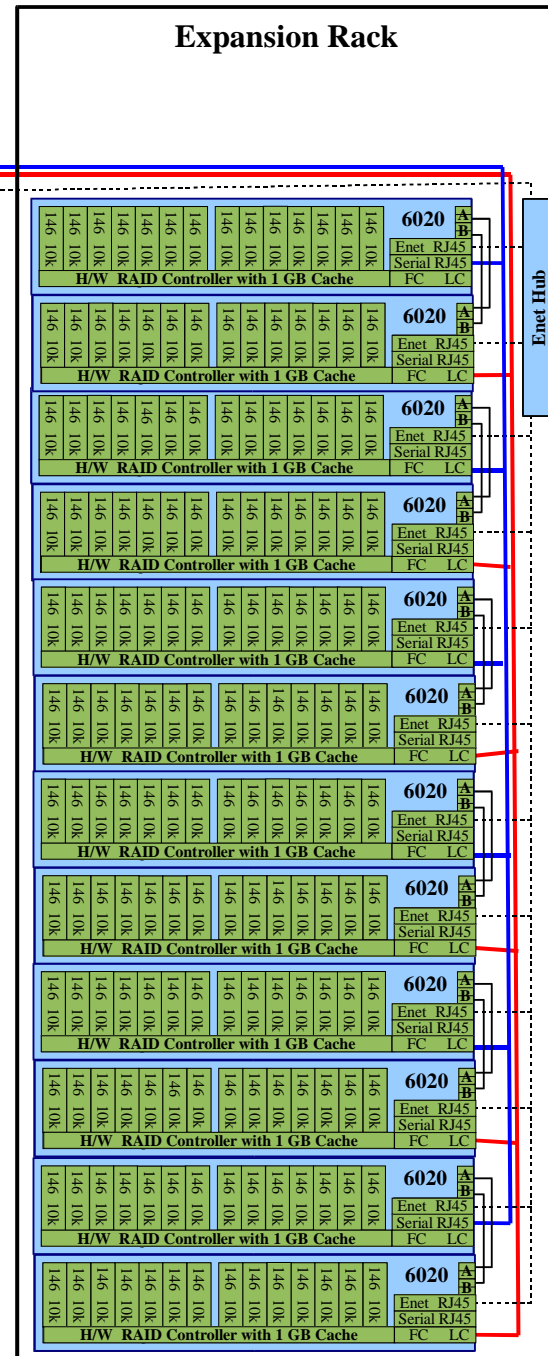
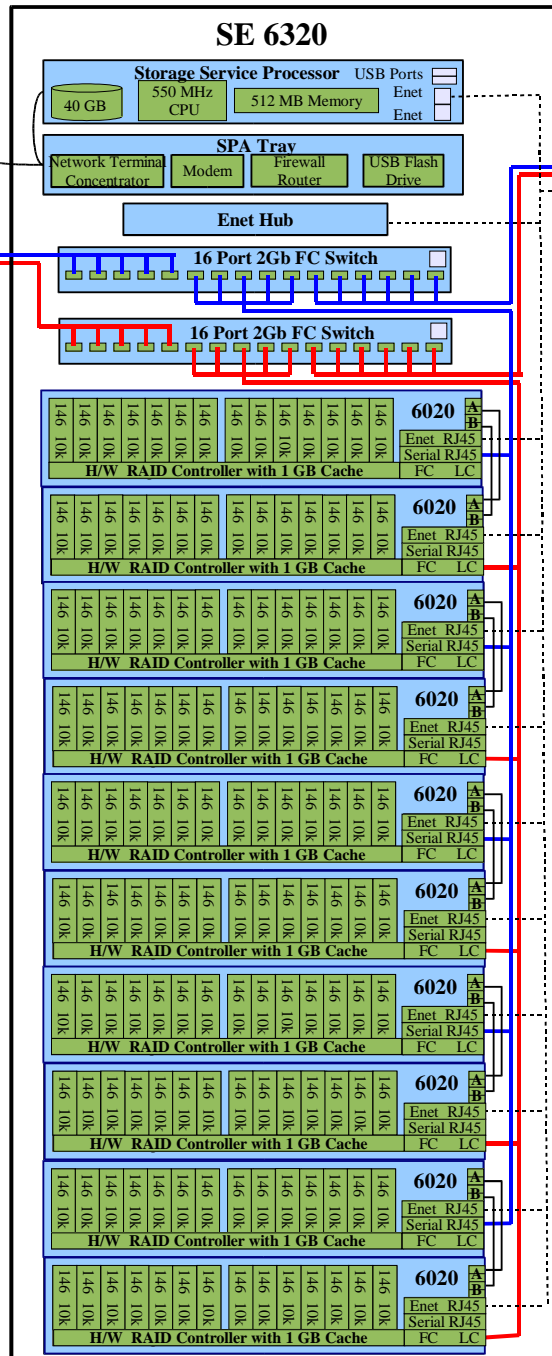

StorEdge 6320 (no internal switches)

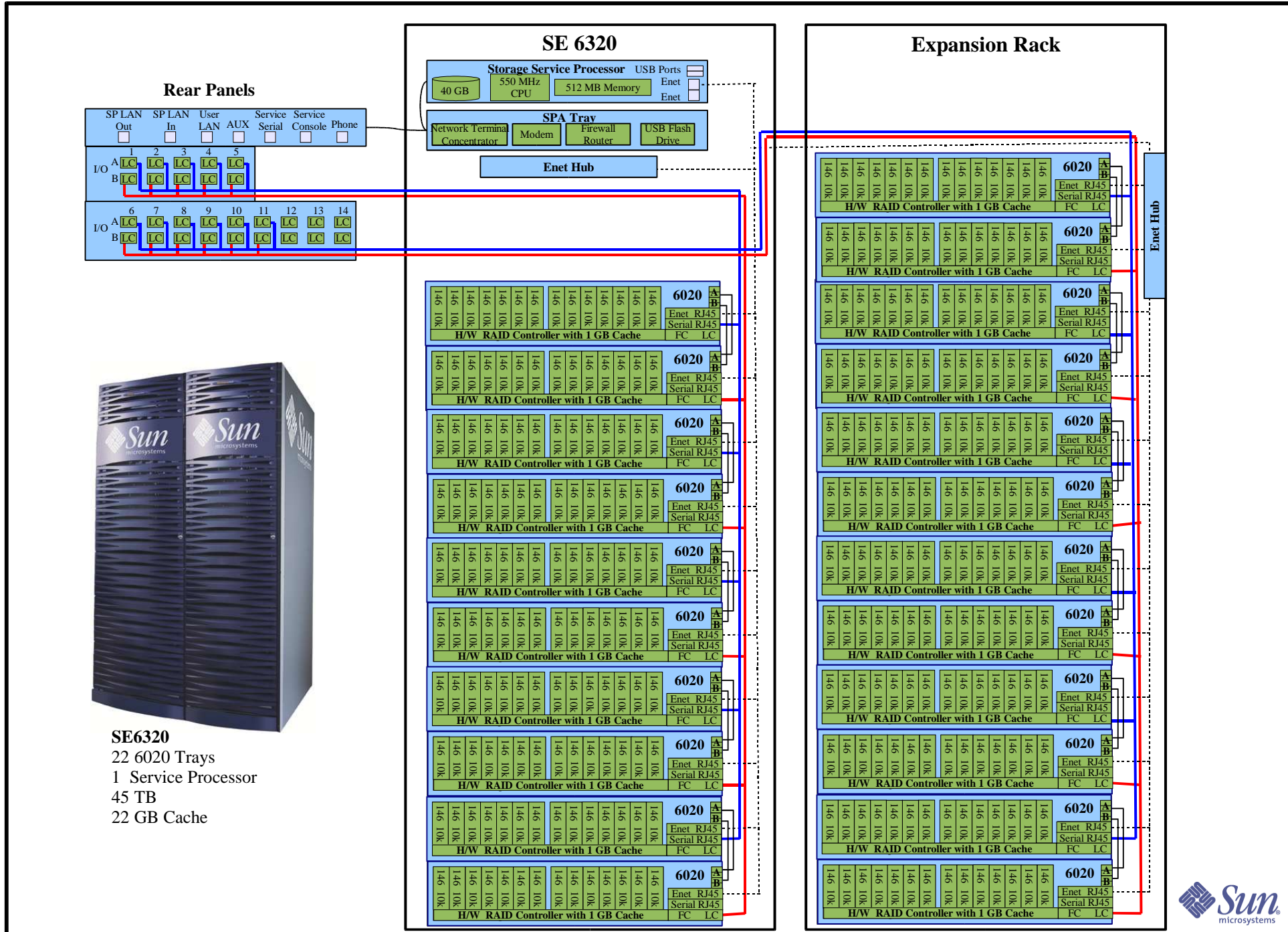

SE6320
 22 6020 Trays
 1 Service Processor
 45 TB
 22 GB Cache



StorEdge 6920

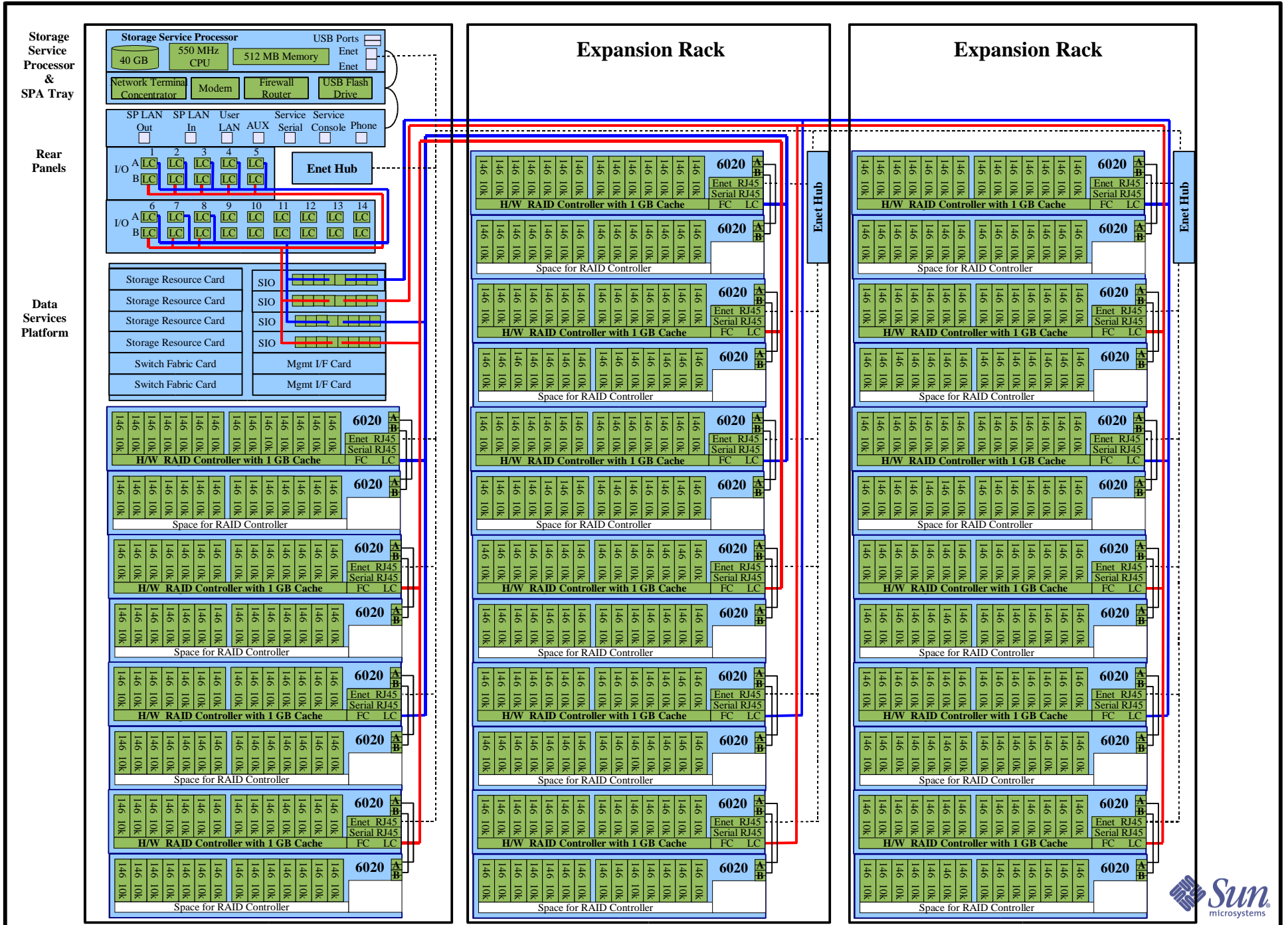

StorEdge 3910

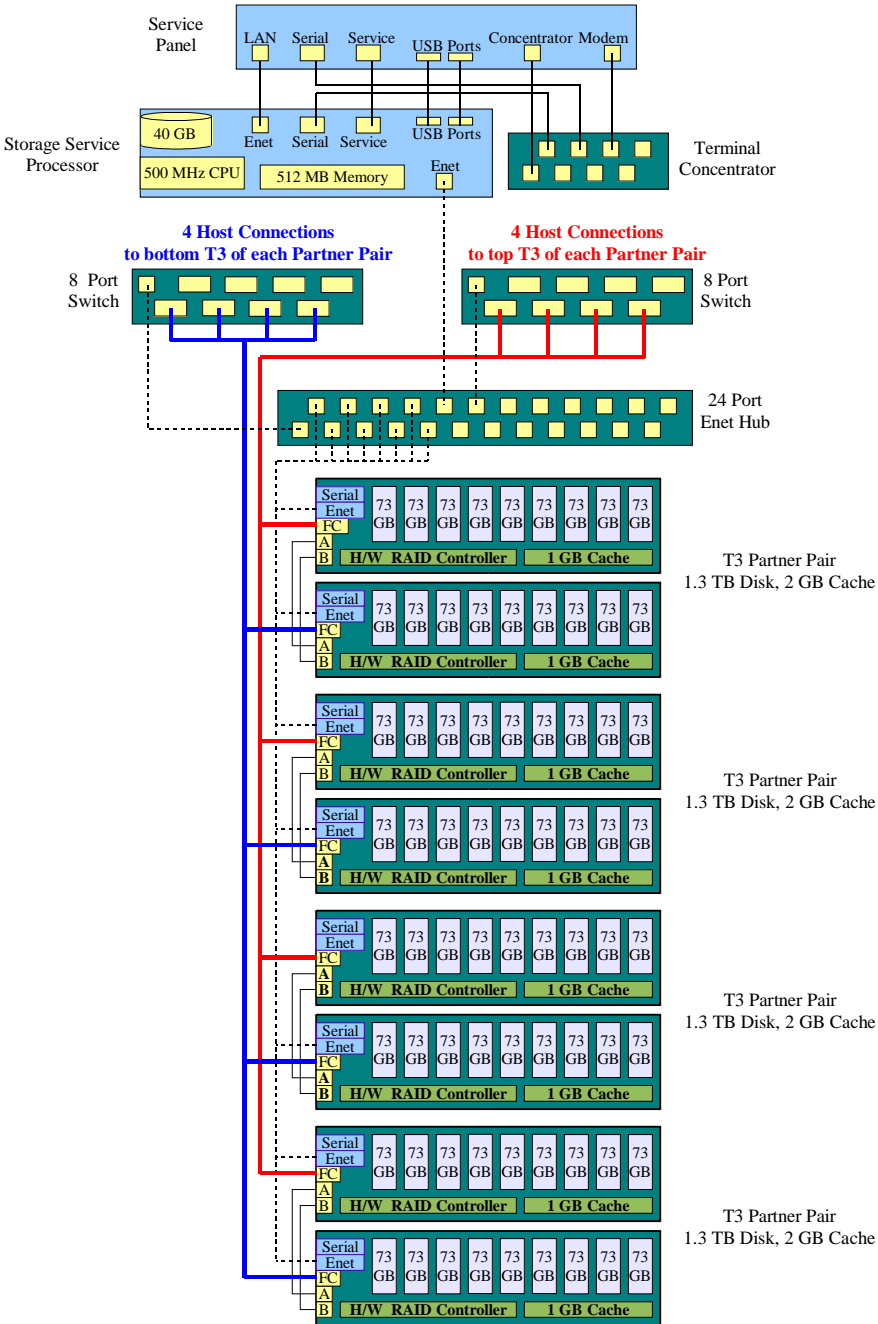

- 3910**
- 4 T3 Partner Pairs
- 2 8 port switches
- 1 Service Processor
- 5.2 TB (12.9 TB)
- 8 GB Cache



StorEdge 3960

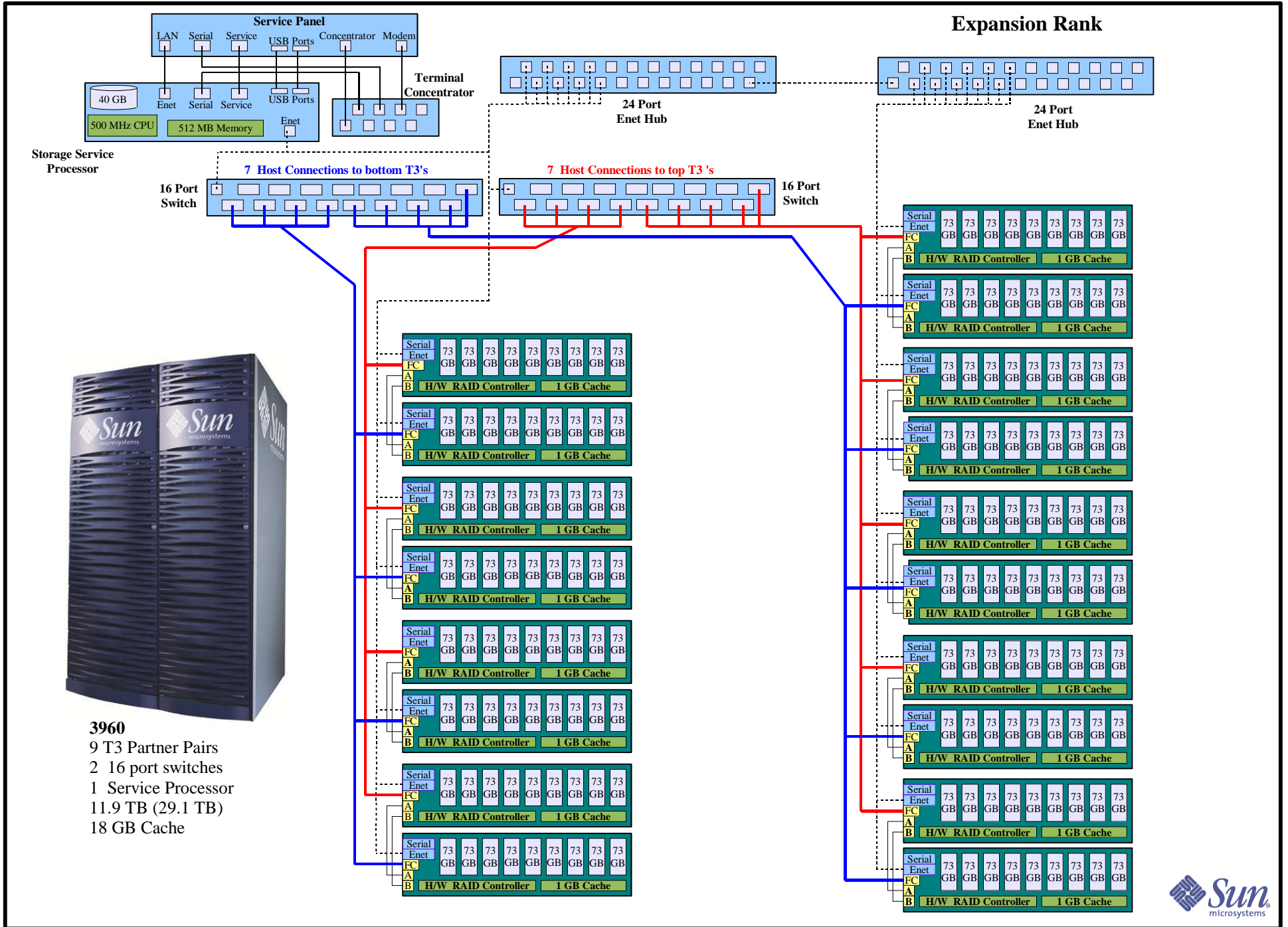

StorEdge 6910



- 6910**
 3 T3 Partner Pairs
 2 8 port switches
 2 Virtualization Engines
 1 Service Processor
 3.9 TB
 6 GB Cache

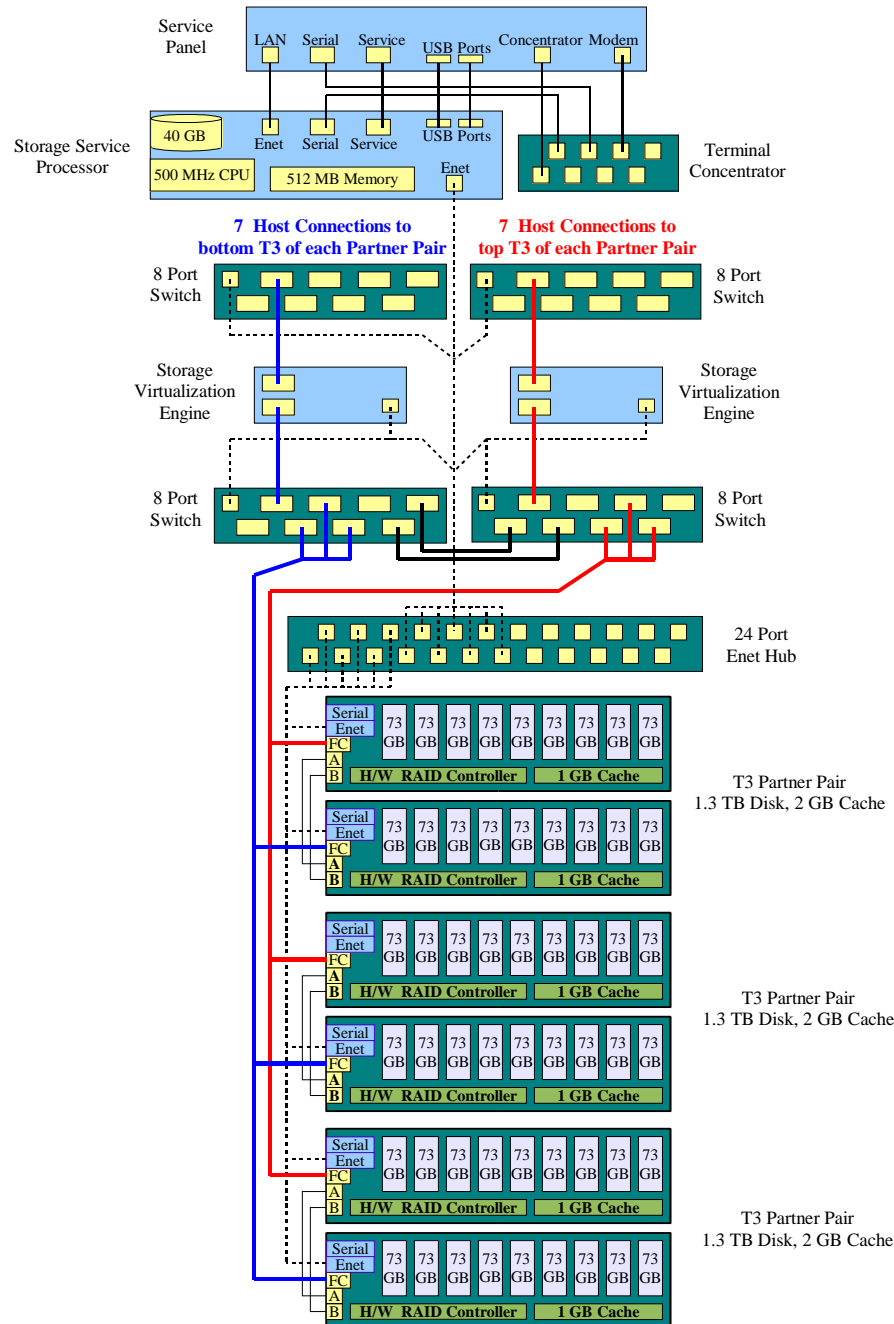

T3 Partner Pair

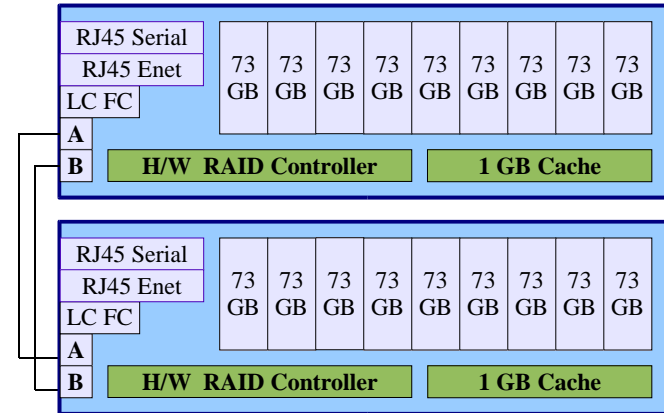

T3 Partner Pair Storage System

Capacity:

18 Disks
 36 GB, 73 GB or 181 GB FC Disks
 655, 1310 or 3250 GB Total
 Dual H/W Raid Controller
 2 GB cache
 N+1 Power & Fans
 Dual power cords each

7U Partner Pair Rack Mount Kit:

X6837A Sun Rack 900 mount kit
 X9667A Sun 72" Cabinet or Sun Fire Cabinet mount kit

4U Single Workgroup Rack Mount Kit:

X6836A Sun Rack 900 mount kit
 X9677A Sun 72" Cabinet or Sun Fire Cabinet mount kit



Disk Cabinets

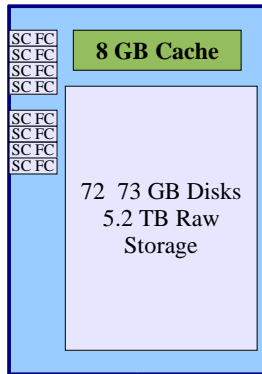
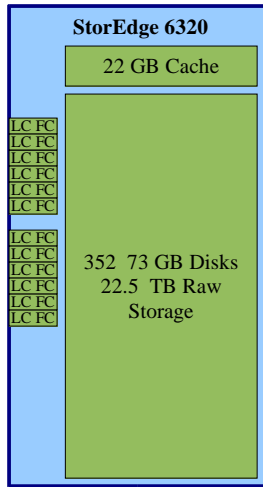

StorEdge 3910

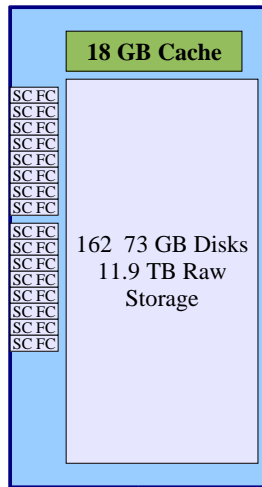

StorEdge 3960

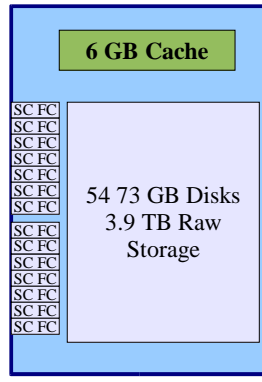

StorEdge 6910

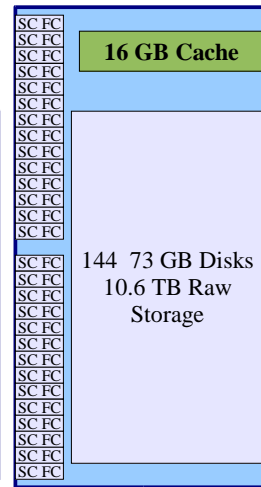

StorEdge 6960

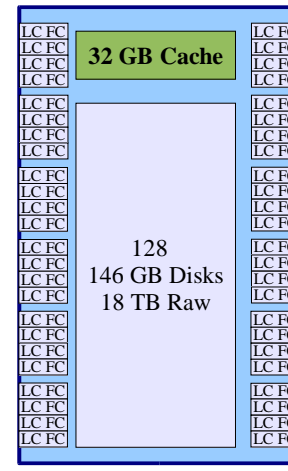

StorEdge 9970

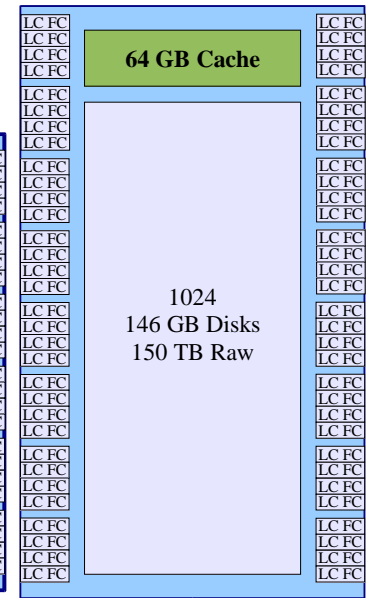

StorEdge 9980



Tape Libraries



L8 Tape Autoloader
 1 Drive: SDLT320, LTO
 or LTO2
 8 Cartridges



L25 Tape Library
 Drives: 2 SDLT320 or 2 LTO
 Cartridges: 21 SDLT320 or 25 LTO

Tape Drive Comparison

Type	Throughput		Capacity
	MB/sec	GB/hr	GB/tape
SDLT320	16	57	160
LTO	15	54	100
LTO2	30	108	200
9840C	30	108	40
9940B	30	108	200

All capacities are native uncompressed capacities.



L100 Tape Library
 Drives: 6 SDLT320 or 6 LTO
 Cartridges: 100 SDLT320
 or 84 LTO



L180 Tape Library
 Drives: 10 SDLT320, 10 LTO2
 or 6 9840.
 174 Cartridges



L700 Tape Library
 20 SDLT320, 20 LTO2, 12 9840,
 or 12 9940 Drives
 678 Cartridges



L6000 Tape Library
 80 9840, or 80 9940 Drives
 6000 Cartridges
 Can Link 26 L6000's together



L8 Tape Autoloader Detail



L8 Tape Library	
LTO2 Drive	Capacity for 8 Cartridges
HD68 HD68	Robotics

Barcode
Reader Option

L8 Tape Library

1 Drive: SDLT320 or LTO2

Cartridges: 8 SDLT320 or 8 LTO2

Ships with rack mount kit for Sun Rack 900

& 72" Cabinet

2 Rack Units

L25 Tape Library Detail



L25 Tape Library	
HD68	Capacity for 25 LTO2 Tapes
LTO2 Drive	
HD68	200 GB each tape
LTO2 Drive	
HD68	Robotics
HD68	

L25 Tape Library

Drives: 2 SDLT320 or 2 LTO2

Cartridges: 21 SDLT320 or 25 LTO2

Ships with rack mount kit for Sun Rack 900

& 72" Cabinet

4 Rack Units

L100 Tape Library Detail

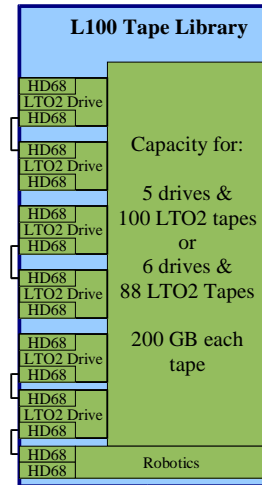

L100 Tape Library

4 LTO2 Drives (6 max)

100 LTO2 Cartridges

Ships with rack mount kit for Sun Rack 900

& 72" Cabinet

13.5 Rack Units

Switches & Hubs

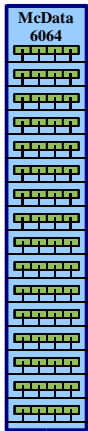

McData 6064
64 Port
2 Gb Switch
w/ 64 SFP's



McData 4500
24 Port
2 Gb Switch
w/ 24 SFP's

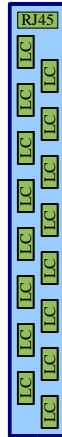

**16 Port
2 Gb Switch
w/ 16 SFP's**



**8 Port
2 Gb Switch
w/ 8 SFP's**



**16 Port
1 Gb Switch
w/ 16 GBIC's**



**8 Port
1 Gb Switch
w/ 8 GBIC's**

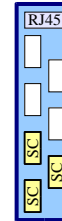

**7 Port Hub
w/ 3 GBIC's**

Switch Example

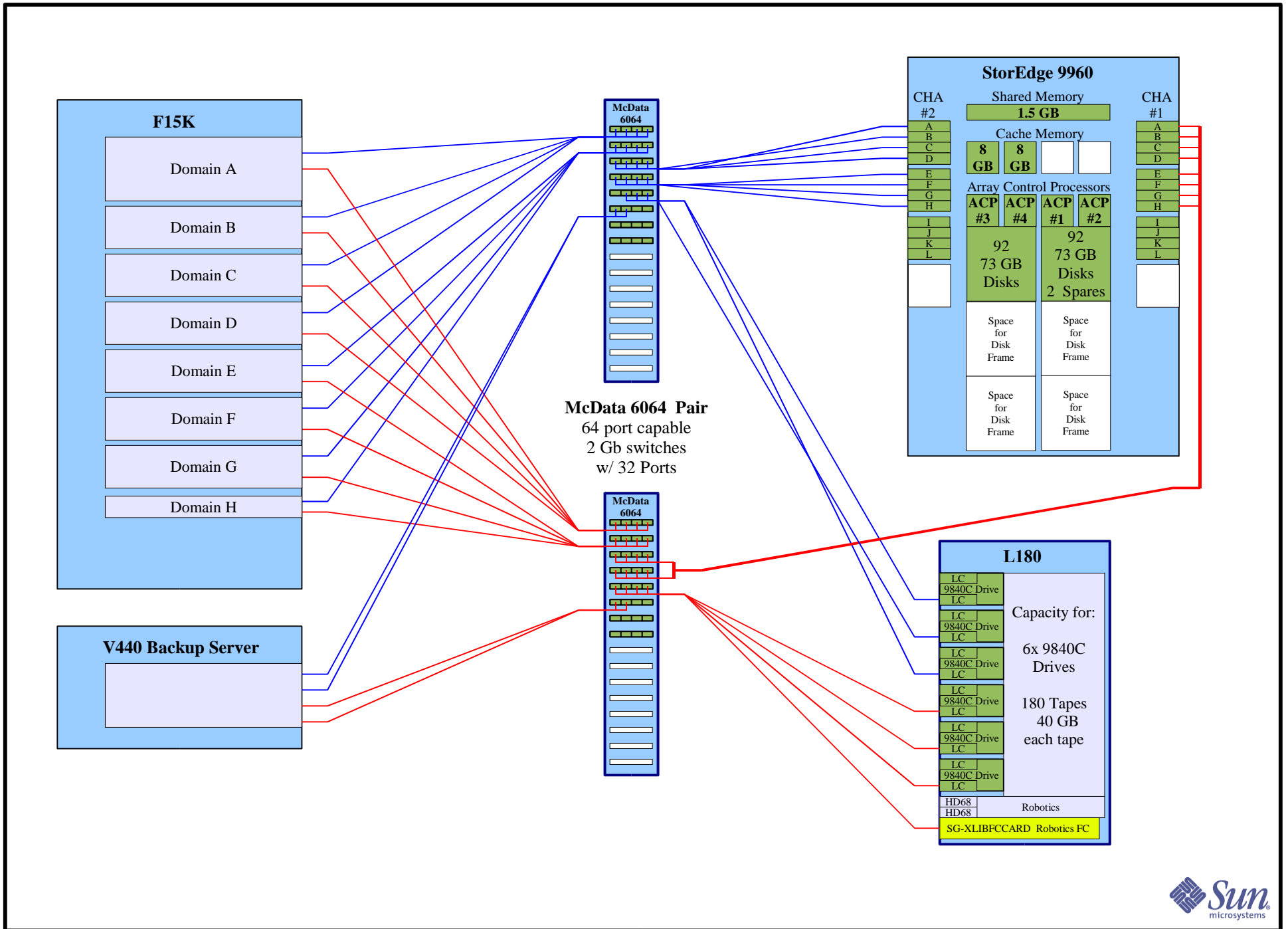

Site Plan

2 ft x 2 ft
Tile

Power cords are
NEMA #L6-30P
200/240 VAC
Single Phase
24 amps each

Power cords are
NEMA L6-20P
200/240 VAC
Single Phase
16 amps each

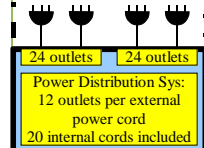
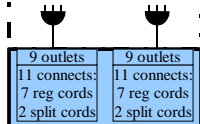

72" Cabinet

Optional Front Door

Sun Rack 900

Optional Front Door

72" Cabinet
24" Width
37" Depth
73.7" Height
Clearances:
48" Front
36" Back

Sun Rack 900
23.5" Width
35.4" Depth
74" Height
Clearances:
48" Front
36" Back

