

Oracle® Enterprise Manager

Advanced Configuration

10g Release 1 (10.1)

Part No. B12013-01

December 2003

Oracle Enterprise Manager Advanced Configuration 10g Release 1 (10.1)

Part No. B12013-01

Copyright © 2003 Oracle. All rights reserved.

Primary Author: Peter LaQuerre

Contributor: Nicole Haba, Ana Hernandez, Tania Le Voi, Murali Bhoopathy, Narain Jagathesan, Julie Wong, Gary Gilchrist, Jaydeep Marfatia, Ravi Pinnamaneni, Yuen Chan, Vitaliy Khizder, Jerry Abramson, Erik DeMember, Dana Joly, Anita Holser, Gang Chen, Leslie Gloyd, Dhaval Shah, Venkat Tummalapalli, Eunhei Jang, Tina Boisvert, Anila Thomas, Steve Viavant, Sridhar Reddy, Jonathan Stone, Lan Nguyen, Dennis Lee, Jackie Gosselin, and Bert Rich.

The Programs (which include both the software and documentation) contain proprietary information; they are provided under a license agreement containing restrictions on use and disclosure and are also protected by copyright, patent, and other intellectual and industrial property laws. Reverse engineering, disassembly, or decompilation of the Programs, except to the extent required to obtain interoperability with other independently created software or as specified by law, is prohibited.

The information contained in this document is subject to change without notice. If you find any problems in the documentation, please report them to us in writing. This document is not warranted to be error-free. Except as may be expressly permitted in your license agreement for these Programs, no part of these Programs may be reproduced or transmitted in any form or by any means, electronic or mechanical, for any purpose.

If the Programs are delivered to the United States Government or anyone licensing or using the Programs on behalf of the United States Government, the following notice is applicable:

U.S. GOVERNMENT RIGHTS Programs, software, databases, and related documentation and technical data delivered to U.S. Government customers are "commercial computer software" or "commercial technical data" pursuant to the applicable Federal Acquisition Regulation and agency-specific supplemental regulations. As such, use, duplication, disclosure, modification, and adaptation of the Programs, including documentation and technical data, shall be subject to the licensing restrictions set forth in the applicable Oracle license agreement, and, to the extent applicable, the additional rights set forth in FAR 52.227-19, Commercial Computer Software--Restricted Rights (June 1987). Oracle Corporation, 500 Oracle Parkway, Redwood City, CA 94065

The Programs are not intended for use in any nuclear, aviation, mass transit, medical, or other inherently dangerous applications. It shall be the licensee's responsibility to take all appropriate fail-safe, backup, redundancy and other measures to ensure the safe use of such applications if the Programs are used for such purposes, and we disclaim liability for any damages caused by such use of the Programs.

Oracle is a registered trademark of Oracle Corporation and/or its affiliates. Other names may be trademarks of their respective owners.

The Programs may provide links to Web sites and access to content, products, and services from third parties. Oracle is not responsible for the availability of, or any content provided on, third-party Web sites. You bear all risks associated with the use of such content. If you choose to purchase any products or services from a third party, the relationship is directly between you and the third party. Oracle is not responsible for: (a) the quality of third-party products or services; or (b) fulfilling any of the terms of the agreement with the third party, including delivery of products or services and warranty obligations related to purchased products or services. Oracle is not responsible for any loss or damage of any sort that you may incur from dealing with any third party.

Contents

Send Us Your Comments	ix
Preface	xi
Intended Audience	xi
Documentation Accessibility	xi
Related Documents	xii
Conventions	xii
1 Introduction to Enterprise Manager Advanced Configuration	
1.1 Types of Advanced Configuration Tasks	1-1
1.2 Understanding the Enterprise Manager Directory Structure	1-1
1.2.1 Understanding the Enterprise Manager Directories Installed with the Oracle Enterprise Manager 10g Grid Control	1-2
1.2.1.1 About the Oracle Management Service Home Directory	1-2
1.2.1.2 About the Oracle Management Agent Home (AGENT_HOME) Directory	1-3
1.2.1.3 Summary of the Important Directories in the Management Service Home	1-3
1.2.2 Understanding the Enterprise Manager Directories Installed with the Management Agent	1-4
1.2.2.1 Summary of the Important Directories in the Management Agent Home	1-4
1.2.2.2 Understanding the Management Agent Directory Structure on Windows	1-5
1.2.3 Understanding the Enterprise Manager Directories Installed with Oracle Application Server	1-5
1.2.4 Understanding the Enterprise Manager Directories Installed with Oracle Database 10g	1-6
1.2.5 Configuring the Database Control During and After the Oracle Database 10g Installation	1-7
1.2.5.1 Configuring the Database Control During Installation	1-7
1.2.5.2 Configuring the Database Control with DBCA	1-8
1.2.5.3 Configuring the Database Control with EMCA	1-10
1.2.5.4 Using an Input File for EMCA Parameters	1-12
1.2.5.5 Using EMCA with Real Application Clusters	1-13
1.2.5.6 EMCA Troubleshooting Tips	1-13
1.3 Starting and Stopping Enterprise Manager Components	1-14
1.3.1 Controlling the Oracle Management Agent	1-14
1.3.1.1 Starting, Stopping, and Checking the Status of the Management Agent	

	on UNIX	1-14
1.3.1.2	Starting and Stopping the Management Agent on Windows.....	1-15
1.3.1.3	Checking the Status of the Management Agent on Windows	1-15
1.3.2	Controlling the Oracle Management Service.....	1-16
1.3.2.1	Using OPMN to Start and Stop the Management Service.....	1-16
1.3.2.2	Using emctl to Start, Stop, and Check the Status of the Oracle Management Service	1-16
1.3.2.3	Starting and Stopping Oracle Application Server Web Cache	1-17
1.3.3	Controlling the Application Server Control	1-18
1.3.4	Controlling the Database Control on UNIX	1-18
1.3.4.1	Starting the Database Control on UNIX.....	1-18
1.3.4.2	Stopping the Database Control on UNIX.....	1-19
1.3.5	Starting and Stopping the Oracle Enterprise Manager 10g Grid Control Framework.....	1-19
1.3.5.1	Starting the Grid Control Framework.....	1-19
1.3.5.2	Stopping the Grid Control Framework.....	1-20
1.4	Additional Management Agent Commands	1-21
1.4.1	Uploading and Reloading Data to the Management Repository	1-22
1.4.2	Specifying New Target Monitoring Credentials.....	1-22
1.4.2.1	Using the Grid Control to Modify the Monitoring Credentials	1-23
1.4.2.2	Using the Enterprise Manager Command Line to Modify the Monitoring Credentials	1-23
1.4.3	Listing the Targets on a Managed Host.....	1-23
1.4.4	Controlling Blackouts.....	1-24
1.5	Enabling Enterprise Manager Accessibility Features	1-26
1.5.1	Enabling Enterprise Manager Accessibility Mode.....	1-26
1.5.2	Providing Textual Descriptions of Enterprise Manager Charts	1-27

2 Enterprise Manager Security

2.1	About Oracle Enterprise Manager Security	2-1
2.1.1	Oracle Enterprise Manager Security Model.....	2-1
2.1.2	Classes of Users and Their Privileges	2-2
2.1.3	Resources Protected.....	2-2
2.1.4	Authorization and Access Enforcement.....	2-3
2.1.5	Leveraging Oracle Application Server Security Services	2-3
2.1.6	Leveraging Oracle Identity Management Infrastructure.....	2-4
2.2	Configuring Security for the Grid Control Framework	2-4
2.2.1	About Enterprise Manager Framework Security	2-4
2.2.2	Overview of the Steps Required to Enable Enterprise Manager Framework Security	2-6
2.2.3	Enabling Security for the Oracle Management Service.....	2-6
2.2.4	Enabling Security for the Oracle Management Agent	2-8
2.2.5	Enabling Security with Multiple Management Service Installations.....	2-10
2.2.6	Restricting HTTP Access to the Management Service	2-10
2.2.7	Managing Agent Registration Passwords.....	2-12
2.2.7.1	Using the Grid Control to Manage Agent Registration Passwords.....	2-12
2.2.7.2	Using emctl to Change the Agent Registration Password	2-13

2.2.8	Enabling Security for the Management Repository Database	2-13
2.2.8.1	About Oracle Advanced Security and the sqlnet.ora Configuration File	2-14
2.2.8.2	Configuring the Management Service to Connect to a Secure Management Repository Database	2-14
2.2.8.3	Enabling Oracle Advanced Security for the Management Repository.....	2-16
2.2.8.4	Enabling Security for the Management Agent that is Monitoring a Secure Management Repository or Database.....	2-17
2.3	Configuring Security for the Enterprise Manager Application Server Control	2-17
2.4	Configuring Security for the Oracle Enterprise Manager 10g Database Control	2-18
2.5	Configuring Enterprise Manager for Use with Oracle Application Server Single Sign-On.....	2-20
2.5.1	Configuring Enterprise Manager to Use the Single Sign-On Logon Page	2-20
2.5.2	Registering Single Sign-On Users as Enterprise Manager Administrators.....	2-22
2.5.3	Grid Control as a Single Sign-On Partner Application	2-23
2.5.4	Bypassing the Single Sign-On Logon Page	2-24
2.6	Configuring Enterprise Manager for Use with Enterprise User Security	2-24
2.7	Additional Security Considerations.....	2-25
2.7.1	Responding to Browser-Specific Security Certificate Alerts	2-25
2.7.1.1	Responding to the Internet Explorer Security Alert Dialog Box	2-25
2.7.1.2	Responding to the Netscape Navigator New Site Certificate Dialog Box	2-26
2.7.1.3	Preventing the Display of the Internet Explorer Security Information Dialog Box.....	2-27
2.7.2	Configuring Beacons to Monitor Web Applications Over HTTPS.....	2-28

3 Configuring Enterprise Manager for Firewalls

3.1	Considerations Before Configuring Your Firewall	3-1
3.2	Firewall Configurations for Enterprise Management Components.....	3-2
3.2.1	Firewalls Between Your Browser and the Grid Control	3-2
3.2.2	Configuring the Management Agent on a Host Protected by a Firewall.....	3-3
3.2.2.1	Configuring the Management Agent to Use a Proxy Server	3-3
3.2.2.2	Configuring the Firewall to Allow Incoming Communication From the Management Service	3-4
3.2.3	Configuring the Management Service on a Host Protected by a Firewall	3-5
3.2.3.1	Configuring the Management Service to Use a Proxy Server.....	3-5
3.2.3.2	About the dontProxyfor Property	3-6
3.2.3.3	Configuring the Firewall to Allow Incoming Management Data From the Management Agents.....	3-7
3.2.4	Firewalls Between the Management Service and the Management Repository	3-7
3.2.5	Firewalls Between the Grid Control and a Managed Database Target	3-8
3.2.6	Firewalls Used with Multiple Management Services.....	3-8
3.2.7	Configuring Firewalls to Allow ICMP and UDP Traffic for Beacons.....	3-9
3.3	Viewing a Summary of the Ports Assigned During the Application Server Installation.	3-9

4 Configuring Application Performance Management

4.1	Before You Begin Configuring Application Performance Management	4-1
4.2	Summary of Application Performance Management Configuration Tasks.....	4-1

4.3	Configuring Transaction Performance Monitoring	4-3
4.3.1	Basic Configuration of Transaction Performance Monitoring	4-4
4.3.2	Advanced Configuration of Transaction Performance Monitoring	4-4
4.3.3	Configuring Business Transaction Tracing	4-5
4.4	Configuring End-User Response Time Monitoring	4-6
4.4.1	Configuring End-User Response Time Monitoring Using Oracle Application Server Release 2 (9.0.4)	4-6
4.4.1.1	Configuring Oracle Application Server Web Cache 9.0.4 for End-User Response Time Monitoring	4-7
4.4.1.2	Starting and Stopping End-User Response Time Monitoring	4-8
4.4.2	Configuring End-User Response Time Monitoring Using Earlier Versions of Oracle Application Server Web Cache	4-8
4.4.2.1	About the chronos_setup Configuration Script	4-9
4.4.2.2	Configuring the Document Root for Each Web Server	4-9
4.4.2.3	Configuring Oracle Application Server Web Cache for End-User Response Time Monitoring	4-10
4.4.2.4	Starting End-User Response Time Monitoring	4-11
4.4.3	Configuring End-User Response Time Monitoring Using Standalone Oracle Application Server Web Cache	4-12
4.4.3.1	Installing Standalone Oracle Application Server Web Cache	4-12
4.4.3.2	Configuring Standalone Oracle Application Server Web Cache	4-12
4.4.3.3	Enabling End-User Response Time Monitoring for Standalone Oracle Application Server Web Cache	4-13
4.4.4	Confirming that End-User Response Time Monitoring is Enabled	4-14
4.5	Configuring OC4J for Middle-Tier URL Performance Monitoring	4-14
4.5.1	Configuring OC4J Tracing for Middle-Tier URL Monitoring	4-15
4.5.2	Additional Configuration for Monitoring UIX Applications	4-16

5 Locating and Configuring Enterprise Manager Log Files

5.1	Locating and Configuring Management Agent Log and Trace Files	5-1
5.1.1	About the Management Agent Log and Trace Files	5-1
5.1.2	Locating the Management Agent Log and Trace Files	5-2
5.1.3	About Management Agent Rollover Files	5-2
5.1.4	Controlling the Size and Number of Management Agent Log and Trace Files	5-3
5.1.5	Controlling the Contents of the Management Agent Trace File	5-4
5.1.6	Controlling the Size and Number of Fetchlet Log and Trace Files	5-4
5.1.7	Controlling the Contents of the Fetchlet Trace File	5-5
5.2	Locating and Configuring Management Service Log and Trace Files	5-6
5.2.1	About the Management Service Log and Trace Files	5-6
5.2.2	Locating the Management Service Log and Trace Files	5-6
5.2.3	Controlling the Size and Number of Management Service Log and Trace Files	5-6
5.2.4	Controlling the Contents of the Management Service Trace File	5-8

6 Maintaining and Troubleshooting the Repository

6.1	Management Repository Deployment Guidelines	6-1
6.2	Management Repository Data Retention Policies	6-2
6.2.1	Management Repository Default Aggregation and Purging Policies	6-2

6.2.2	Management Repository Default Aggregation and Purging Policies for Other Management Data	6-3
6.2.3	Modifying the Default Aggregation and Purging Policies	6-3
6.2.4	Modifying Data Retention Policies When Targets Are Deleted	6-5
6.3	Requirement to Manually Analyze Specific Management Repository Tables	6-5
6.4	Changing the SYSMAN Password	6-7
6.5	Dropping and Recreating the Management Repository	6-8
6.5.1	Dropping the Management Repository.....	6-8
6.5.2	Recreating the Management Repository	6-9
6.5.2.1	Using the RepManager Script to Create the Management Repository.....	6-9
6.5.2.2	Using a Connect Descriptor to Identify the Management Repository Database.....	6-10
6.6	Troubleshooting Management Repository Creation Errors	6-10
6.6.1	"Package Body Does Not Exist" Error While Creating the Repository	6-11
6.6.2	"Server Connection Hung" Error While Creating the Repository	6-11
6.6.3	General Troubleshooting Techniques for Creating the Repository	6-11

7 Reconfiguring the Management Agent and Management Service

7.1	Reconfiguring the Oracle Management Agent.....	7-1
7.1.1	Configuring the Management Agent to Use a New Management Service.....	7-1
7.1.2	Changing the Management Agent Port.....	7-2
7.1.3	Controlling the Amount of Disk Space Used by the Management Agent	7-3
7.1.4	About the Management Agent Watchdog Process.....	7-4
7.1.5	Setting the Management Agent Time Zone	7-4
7.1.5.1	Understanding How the Management Agent Obtains Time Zone Information	7-5
7.1.5.2	Troubleshooting Management Agent Time Zone Problems.....	7-5
7.1.5.3	Troubleshooting Oracle Management Service Time Zone Problems	7-6
7.2	Reconfiguring the Oracle Management Service	7-7
7.2.1	Configuring the Management Service to Use a New Repository	7-7
7.2.1.1	Changing the Repository Properties in the emoms.properties File	7-7
7.2.1.2	About Changing the Repository Password	7-8
7.2.2	Configuring the Management Service to Use a New Port.....	7-8

8 Migrating from Previous Versions of Enterprise Manager

8.1	Overview of the Enterprise Manager Migration Process.....	8-1
8.2	Requirements for Migrating from Previous Versions of Enterprise Manager.....	8-1
8.3	The Oracle Enterprise Manager 10g Migration Process	8-2
8.3.1	Deploying and Configuring Oracle Enterprise Manager 10g Management Agents .	8-2
8.3.1.1	Deploying the Oracle Enterprise Manager 10g Management Agents Using the Release 2.2, Release 9.0.1, or Release 9.2 Job System	8-3
8.3.1.1.1	More About the Directory Type Parameter.....	8-5
8.3.1.2	Configuring the Oracle Enterprise Manager 10g Management Agents for Use with the Oracle Enterprise Manager 10g Job System (UNIX Systems Only).....	8-6
8.3.2	Migrating Management Repository Data	8-7
8.4	Configuring Metric Thresholds	8-8

8.4.1	Copying Metric Thresholds to Multiple Targets.....	8-8
-------	--	-----

9 Configuring Notifications

9.1	Setting Up Notifications.....	9-1
9.2	Managing Notification Methods.....	9-2
9.2.1	Setting Up a Mail Server for Notifications.....	9-2
9.2.2	Custom Notification Methods using Scripts and SNMP Traps	9-4
9.2.2.1	Adding a Notification Method based on an OS Command	9-4
9.2.2.2	Adding a Notification Method Based on a PL/SQL Procedure.....	9-5
9.2.2.3	Adding a Notification Method Based on an SNMP Trap.....	9-6
9.2.3	Passing Metric Severity Information	9-8
9.2.3.1	Passing Information to an OS Script or Executable.....	9-8
9.2.3.2	Passing Information to a PL/SQL Procedure.....	9-10
9.3	Notification Rules	9-12
9.4	Default Notification Rules	9-13
9.5	Creating Your Own Notification Rules	9-17
9.6	Getting Email Notifications	9-17
9.6.1	Notification Schedules	9-18
9.6.2	Using Out-of-Box Notification Rules.....	9-19
9.6.3	Creating Your Own Notification Rules	9-19
9.7	Configuring Methods for Rules	9-19
9.8	Assigning Methods to Rules.....	9-20
9.9	Assigning Rules to Methods.....	9-20
9.10	Management Information Base (MIB).....	9-21
9.10.1	About MIBs.....	9-21
9.10.2	Reading the MIB Variable Descriptions	9-22
9.10.2.1	Variable Name	9-22
9.10.3	MIB Definition.....	9-23

10 Additional Configuration Tasks

10.1	Understanding Default and Custom Data Collections.....	10-1
10.1.1	How Enterprise Manager Stores Default Collection Information.....	10-1
10.1.2	Restoring Default Collection Settings.....	10-2
10.2	Enabling Multi-Inventory Support for Configuration Management	10-2
10.3	Manually Configuring a Database Target for Complete Monitoring	10-3
10.4	Modifying the Default Login Timeout Value	10-6

Index

Send Us Your Comments

Oracle Enterprise Manager Advanced Configuration, 10g Release 1 (10.1)

Part No. B12013-01

Oracle welcomes your comments and suggestions on the quality and usefulness of this publication. Your input is an important part of the information used for revision.

- Did you find any errors?
- Is the information clearly presented?
- Do you need more information? If so, where?
- Are the examples correct? Do you need more examples?
- What features did you like most about this manual?

If you find any errors or have any other suggestions for improvement, please indicate the title and part number of the documentation and the chapter, section, and page number (if available). You can send comments to us in the following ways:

- Electronic mail: nedc-doc_us@oracle.com
- FAX: (603) 897-3317. Attn: Oracle Enterprise Manager 10g
- Postal service:

Oracle Corporation
Oracle Enterprise Manager 10g Documentation
1 Oracle Drive
Nashua, NH 03062
USA

If you would like a reply, please give your name, address, telephone number, and electronic mail address (optional).

If you have problems with the software, please contact your local Oracle Support Services.

Preface

This guide describes advanced configuration tasks you can perform after you have installed Oracle Enterprise Manager and have started using the software. These tasks are optional and provide additional functionality for specific types of Oracle Enterprise Manager customers.

Intended Audience

This guide is written for system administrators who want to configure the advanced features of Oracle Enterprise Manager 10g. You should already be familiar with Oracle and the administrative tasks you want to perform.

You should also be familiar with the operation of your specific UNIX or Windows system. Refer to the documentation for your platform-specific documentation, if necessary.

Documentation Accessibility

Our goal is to make Oracle products, services, and supporting documentation accessible, with good usability, to the disabled community. To that end, our documentation includes features that make information available to users of assistive technology. This documentation is available in HTML format, and contains markup to facilitate access by the disabled community. Standards will continue to evolve over time, and Oracle is actively engaged with other market-leading technology vendors to address technical obstacles so that our documentation can be accessible to all of our customers. For additional information, visit the Oracle Accessibility Program Web site at

<http://www.oracle.com/accessibility/>

Accessibility of Code Examples in Documentation JAWS, a Windows screen reader, may not always correctly read the code examples in this document. The conventions for writing code require that closing braces should appear on an otherwise empty line; however, JAWS may not always read a line of text that consists solely of a bracket or brace.

Accessibility of Links to External Web Sites in Documentation This documentation may contain links to Web sites of other companies or organizations that Oracle does not own or control. Oracle neither evaluates nor makes any representations regarding the accessibility of these Web sites.

Related Documents

For more information about Oracle Enterprise Manager 10g, see the following resources:

- *Oracle Enterprise Manager Basic Installation and Configuration*
- *Oracle Enterprise Manager Concepts*
- *Extending Oracle Enterprise Manager*
- The Enterprise Manager online help, which is available by clicking the **Help** link at the top of any page in the Oracle Enterprise Manager 10g Grid Control.

Conventions

This section describes the conventions used in the text and code examples of this document. It describes:

- [Conventions in Text](#)
- [Conventions in Code Examples](#)

Conventions in Text

The following table describes conventions used in the body of the document.

Convention	Meaning	Example
Bold	Bold typeface indicates terms that are defined in the text or terms that appear in a glossary, or both.	When you specify this clause, you create an index-organized table .
<i>Italics</i>	Italic typeface indicates book titles or emphasis.	<i>Oracle Database Concepts</i> Ensure that the recovery catalog and target database do <i>not</i> reside on the same disk.
UPPERCASE monospace (fixed-width font)	Uppercase monospace typeface indicates elements supplied by the system. Such elements include parameters, privileges, datatypes, RMAN keywords, SQL keywords, SQL*Plus or utility commands, packages and methods, as well as system-supplied column names, database objects and structures, usernames, and roles.	You can specify this clause only for a NUMBER column. You can back up the database by using the BACKUP command. Query the TABLE_NAME column in the USER_TABLES data dictionary view. Use the DBMS_STATS.GENERATE_STATS procedure.
lowercase monospace (fixed-width font)	Lowercase monospace typeface indicates executables, filenames, directory names, and sample user-supplied elements. Such elements include computer and database names, net service names, and connect identifiers, as well as user-supplied database objects and structures, column names, packages and classes, usernames and roles, program units, and parameter values. Note: Some programmatic elements use a mixture of UPPERCASE and lowercase. Enter these elements as shown.	Enter sqlplus to open SQL*Plus. The password is specified in the orapwd file. Back up the datafiles and control files in the /disk1/oracle/dbs directory. The department_id, department_name, and location_id columns are in the hr.departments table. Set the QUERY_REWRITE_ENABLED initialization parameter to true. Connect as oe user. The JReplUtil class implements these methods.

Convention	Meaning	Example
<i>lowercase monospace (fixed-width font) italic</i>	Lowercase monospace italic font represents placeholders or variables.	You can specify the <i>parallel_clause</i> . Run <i>Uold_release</i> .SQL where <i>old_release</i> refers to the release you installed prior to upgrading.

Conventions in Code Examples

Code examples illustrate SQL, PL/SQL, SQL*Plus, or other command-line statements. They are displayed in a monospace (fixed-width) font and separated from normal text as shown in this example:

```
SELECT username FROM dba_users WHERE username = 'MIGRATE';
```

The following table describes typographic conventions used in code examples and provides examples of their use.

Convention	Meaning	Example
[]	Brackets enclose one or more optional items. Do not enter the brackets.	DECIMAL (<i>digits</i> [, <i>precision</i>])
< >	Angle brackets in command syntax denote an item for which you can substitute a real value. Do not enter the angle brackets.	<host>:<port>:<oracle_sid>
{ }	Braces enclose two or more items, one of which is required. Do not enter the braces.	{ENABLE DISABLE}
	A vertical bar represents a choice of two or more options within brackets or braces. Enter one of the options. Do not enter the vertical bar.	{ENABLE DISABLE} [COMPRESS NOCOMPRESS]
...	Horizontal ellipsis points indicate either: <ul style="list-style-type: none"> That we have omitted parts of the code that are not directly related to the example That you can repeat a portion of the code 	CREATE TABLE ... AS <i>subquery</i> ; SELECT <i>col1</i> , <i>col2</i> , ... , <i>coln</i> FROM employees;
.	Vertical ellipsis points indicate that we have omitted several lines of code not directly related to the example.	
<i>Italics</i>	Italicized text indicates placeholders or variables for which you must supply particular values.	CONNECT SYSTEM/ <i>system_password</i> DB_NAME = <i>database_name</i>
UPPERCASE	Uppercase typeface indicates elements supplied by the system. We show these terms in uppercase in order to distinguish them from terms you define. Unless terms appear in brackets, enter them in the order and with the spelling shown. However, because these terms are not case sensitive, you can enter them in lowercase.	SELECT last_name, employee_id FROM employees; SELECT * FROM USER_TABLES; DROP TABLE hr.employees;

Convention	Meaning	Example
lowercase	Lowercase typeface indicates programmatic elements that you supply. For example, lowercase indicates names of tables, columns, or files. Note: Some programmatic elements use a mixture of UPPERCASE and lowercase. Enter these elements as shown.	<pre>SELECT last_name, employee_id FROM employees; sqlplus hr/hr CREATE USER mjones IDENTIFIED BY ty3MU9;</pre>

Introduction to Enterprise Manager Advanced Configuration

This chapter introduces you to Enterprise Manager advanced configuration and provides some basic information about your Enterprise Manager installation. It describes the directory structure, the command-line interface, and how to make Enterprise Manager accessible to all your users.

After you review this chapter, you can move on to the other advanced configuration tasks described in this manual.

Specifically, this chapter includes the following topics:

- [Types of Advanced Configuration Tasks](#)
- [Understanding the Enterprise Manager Directory Structure](#)
- [Starting and Stopping Enterprise Manager Components](#)
- [Enabling Enterprise Manager Accessibility Features](#)

1.1 Types of Advanced Configuration Tasks

Enterprise Manager is designed to install easily with a set of standard configuration settings so you can get up and running with the software quickly.

However, Oracle realizes that hardware and software management requirements vary dramatically among business enterprises. As a result, Enterprise Manager can be reconfigured after installation so you can:

- Implement Enterprise Manager security and firewall features.
- Enable End-User Performance Monitoring for your Web applications.
- Reconfigure Enterprise Manager components when you need to modify the topology of your network environment.
- Maintain and troubleshoot the Enterprise Manager components as your business grows.

1.2 Understanding the Enterprise Manager Directory Structure

Before you perform maintenance and advanced configuration tasks, you should be familiar with the directories and files that are copied to disk when you install Enterprise Manager. Understanding where specific files are located can help you if you need to troubleshoot installation or configuration problems.

The directories and files installed by Enterprise Manager vary, depending upon the installation options you select during the Enterprise Manager installation. The location of Enterprise Manager files and directories also varies slightly when Enterprise Manager is installed as part of an Oracle Application Server or Oracle Database 10g installation.

Use the following sections to become familiar with the directories that are created on your disk when you install Enterprise Manager:

- [Understanding the Enterprise Manager Directories Installed with the Oracle Enterprise Manager 10g Grid Control](#)
- [Understanding the Enterprise Manager Directories Installed with the Management Agent](#)
- [Understanding the Enterprise Manager Directories Installed with Oracle Application Server](#)
- [Understanding the Enterprise Manager Directories Installed with Oracle Database 10g](#)

1.2.1 Understanding the Enterprise Manager Directories Installed with the Oracle Enterprise Manager 10g Grid Control

When you install the Oracle Enterprise Manager 10g Grid Control, you can select from four installation types. All of these installation types, except the Oracle Management Agent installation type, install the Oracle Management Service.

When you install the Oracle Management Service, you actually install two Oracle home directories:

- The Management Service home directory
- The Management Agent home directory

1.2.1.1 About the Oracle Management Service Home Directory

The Oracle Management Service is a J2EE application that is installed and deployed using Oracle Application Server. As a result, when you install the Oracle Management Service, the installation procedure first installs Oracle Application Server. Specifically, the installation procedure installs the Oracle Application Server J2EE and Web Cache installation type, which is used to deploy the Oracle Management Service.

The installation procedure installs the Enterprise Manager components within the Oracle Application Server Home, including:

- The Oracle Management Service
- Optionally, the Oracle Management Repository

Information about the directories that are specific to the Oracle Application Server installation can be found in the Oracle Application Server documentation. For example, the location of the most of the Oracle Application Server configuration and log files are described in the Oracle Application Server documentation.

See Also: "Configuration Files and Log Files" in the *Oracle Application Server 10g Administrator's Guide*

1.2.1.2 About the Oracle Management Agent Home (AGENT_HOME) Directory

In addition to the Management Service home directory, the installation procedure installs the Oracle Management Agent that is used to gather management data and perform administration tasks for the targets on the Management Service host.

By default, if the Oracle Universal Installer (or the account used to run the Universal Installer) has the proper privileges to write to the install directories, the Management Agent is installed in a separate Oracle home directory at the same level as the Oracle Application Server home directory.

However, if the Oracle Universal Installer does not have the proper privileges, the Management Agent is installed in a subdirectory of the Oracle Application Server home directory.

1.2.1.3 Summary of the Important Directories in the Management Service Home

Figure 1–1 shows some of the important directories you should be familiar with in a typical Grid Control installation. You can use this information as you begin to maintain, troubleshoot, and configure the Oracle Management Service installation.

Figure 1–1 Important Oracle Management Service Installation Directories

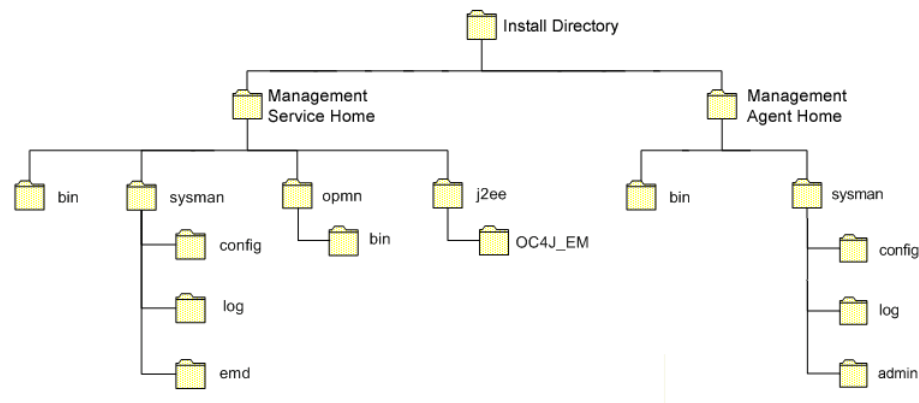

Table 1–1 describes in more detail the Management Service directories shown in Figure 1–1. In the table, ORACLE_HOME refers to the Management Service home directory in which the Oracle Management Service is installed and deployed.

Table 1–1 Important Directories in the Management Service Oracle Home

Directory	Description
ORACLE_HOME/bin	<p>The bin directory in the Oracle Application Server Home contains commands used to control the components of the Oracle Application Server J2EE and Web Cache installation, including the Application Server Control, which is used to monitor and configure Oracle Application Server instances.</p> <p>Use the <code>emctl</code> command in this directory to start and stop the Application Server Control. For more information about the Application Server Control, see the <i>Oracle Application Server 10g Administrator's Guide</i>.</p>

Table 1–1 (Cont.) Important Directories in the Management Service Oracle Home

Directory	Description
ORACLE_HOME/sysman	The <code>sysman</code> directory in the Oracle Application Server Home contains the system management files associated with this Oracle Application Server Release 2 (9.0.4) installation. Note that the <code>ORACLE_HOME/sysman/log</code> directory contains the Oracle Management Service log files (<code>emoms.log</code>) and trace files (<code>emoms.trc</code>).
ORACLE_HOME/opmn	This directory contains files used to control the Oracle Process Manager and Notification (OPMN) utility. OPMN can be used to start and stop the instances of Oracle Application Server Containers for J2EE (OC4J) associated with this instance of Oracle Application Server. The Oracle Management Service runs as an application in one of those OC4J instances.
ORACLE_HOME/j2ee	This directory contains the files associated with the OC4J instances running in this instance of Oracle Application Server. For example, you will notice a directory for the OC4J_EM instance, which is the OC4J instance used to deploy the Management Service J2EE Web application.

1.2.2 Understanding the Enterprise Manager Directories Installed with the Management Agent

The Management Agent is installed automatically when you install the Grid Control. This local instance of the Management Agent gathers management information about the targets on the Management Service host. You can then manage those targets, such as the host itself, from the Grid Control.

The Management Agent is also available as its own install type. This enables you to install the Management Agent on the hosts throughout your enterprise. The Management Agent can then gather management data about the targets on each host so those targets can be managed from the Grid Control.

When you select the Additional Management Agent installation type, you install only the files required to run the Management Agent.

Specifically, the Management Agent files are installed into the same directory structure shown in the `agent` directory when you install the Oracle Management Service (Figure 1–1).

The directory that contains the files required to run the Management Agent is referred to as the `AGENT_HOME` directory. For example, to start or stop an Oracle Management Agent, you use the `emctl` command located in the `bin` directory of the `AGENT_HOME`. Similarly, to configure the log files for the Management Agent, you modify the configuration files in the `sysman/config` directory of the `AGENT_HOME`.

1.2.2.1 Summary of the Important Directories in the Management Agent Home

Table 1–2 describes some of the important subdirectories inside the `AGENT_HOME` directory.

Table 1–2 Important Directories in the AGENT_HOME Directory

Directory	Description
AGENT_HOME	<p>The agent directory contains all the files required to configure and run the Oracle Management Agent on this host.</p> <p>This directory serves as the Oracle Home for the Management Agent. Later in this document, this directory is referred to as the AGENT_HOME.</p> <p>If you install only the Management Agent on a managed host, only the files in this directory are installed. For more information, see "Understanding the Enterprise Manager Directories Installed with the Management Agent" on page 1-4.</p>
AGENT_HOME/bin	<p>The agent/bin directory in the Oracle Application Server Home contains the emctl command that controls the Management Agent for this host.</p> <p>You use the emctl command in this directory to start and stop the Oracle Management Agent on this host.</p>
AGENT_HOME/sysman/admin	<p>This directory contains the files used by the Management Agent to define target types (such as databases, hosts, and so on), to run configuration scripts, and other administrative tasks.</p>
AGENT_HOME/sysman/config	<p>This directory contains the configuration files for the Management Agent. For example, this is where Enterprise Manager stores the emd.properties file. The emd.properties file defines settings such as the Management Service upload URL for this particular agent.</p>
AGENT_HOME/sysman/log	<p>This directory contains the log files for the Management Agent.</p>

1.2.2.2 Understanding the Management Agent Directory Structure on Windows

When you install the Management Agent on a Windows system, the directory structure of the AGENT_HOME directory is the same as the directory structure for installations on a UNIX system.

For example, if you installed the Management Agent in the E:\oracle\em10gAgent directory of your Windows system, you can locate the emctl command for the Management Agent on a Windows system, by navigating to the following directory:

```
$PROMPT> E:\oracle\em10gAgent\bin
```

1.2.3 Understanding the Enterprise Manager Directories Installed with Oracle Application Server

When you install Oracle Application Server (Oracle Application Server), you also install the Oracle Enterprise Manager 10g Application Server Control. The Application Server Control provides you with the Enterprise Manager features required to manage your Oracle Application Server installation. As a result, the Oracle Application Server installation procedure installs a set of Enterprise Manager directories and files into each Oracle Application Server home directory.

In particular, the emctl commands required to control the Application Server Control are installed into the ORACLE_HOME/bin directory. The configuration and log files for the Application Server Control are installed into the ORACLE_HOME/sysman directory structure.

See Also: ["Starting and Stopping Enterprise Manager Components"](#) on page 1-14

["Locating and Configuring Enterprise Manager Log Files"](#) on page 5-1

1.2.4 Understanding the Enterprise Manager Directories Installed with Oracle Database 10g

When you install Oracle Database 10g, you also install the Oracle Enterprise Manager 10g Database Control. The Database Control provides the tools you need to manage your Oracle Database 10g immediately after you install the database. As a result, the Oracle Database 10g installation procedure installs a set of Enterprise Manager directories and files into each Oracle Database 10g home directory.

In particular, the `emctl` commands required to control the Database Control are installed into the `ORACLE_HOME/bin` directory.

The Management Agent and Management Service support files are installed in two locations in an Oracle Database 10g installation:

- Files that are common and shared among all instances of the database are stored in the following directory of the Oracle Database 10g home:

```
ORACLE_HOME/sysman
```

For example, the administration files, which define the supported target types and the scripts used to perform Management Agent configuration tasks are stored in the `ORACLE_HOME/sysman/admin` directory.

- Files that are unique to each instance of the database are stored in following directory of the Oracle Database 10g home:

```
ORACLE_HOME/hostname_sid/
```

For example, if the database host name is `mgmt1.acme.com` and the system identifier for the database instance is `db42`, the log files for the Management Agent and Management Service for that instance are installed in the following directory:

```
ORACLE_HOME/mgmt1.acme.com_db42/sysman/log
```

See Also: ["Locating and Configuring Enterprise Manager Log Files"](#) on page 5-1

If a `hostname_sid` directory does not exist in the Oracle Database 10g home directory, then the Oracle Enterprise Manager Database Control was never configured for the database instance.

See Also: ["Configuring the Database Control During and After the Oracle Database 10g Installation"](#) on page 1-7

In addition, the files required to deploy the Database Control as a J2EE application are installed into the `ORACLE_HOME/oc4j/j2ee` directory structure. The Database Control is a J2EE application that is deployed using the standalone version of Oracle Application Server Containers for J2EE (OC4J). The `OC4J_DBConsole` directory contains the template files that are used to create database-specific deployment directories for each Database Control deployed in the Oracle home.

Figure 1–2 summarizes the location of the important Enterprise Manager directories in a typical Oracle Database 10g home directory.

Figure 1–2 Important Enterprise Manager Directories in an Oracle Database 10g Installation

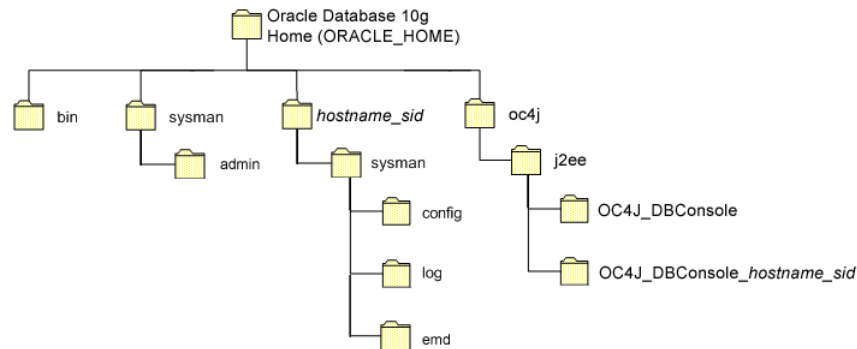

1.2.5 Configuring the Database Control During and After the Oracle Database 10g Installation

The following sections describe how the Oracle Enterprise Manager Database Control is configured during the Oracle Database 10g installation. These sections also describe how you can configure the Database Control after the installation:

- [Configuring the Database Control During Installation](#)
- [Configuring the Database Control with DBCA](#)
- [Configuring the Database Control with EMCA](#)
- [Using EMCA with Real Application Clusters](#)
- [EMCA Troubleshooting Tips](#)

1.2.5.1 Configuring the Database Control During Installation

If you create a database while installing Oracle Database 10g, you have the option of configuring your database so it can be managed by Oracle Enterprise Manager 10g Grid Control or by Oracle Enterprise Manager Database Control.

Figure 1–3 shows the Management Options page, which allows you to select your database management options while installing Oracle Database 10g.

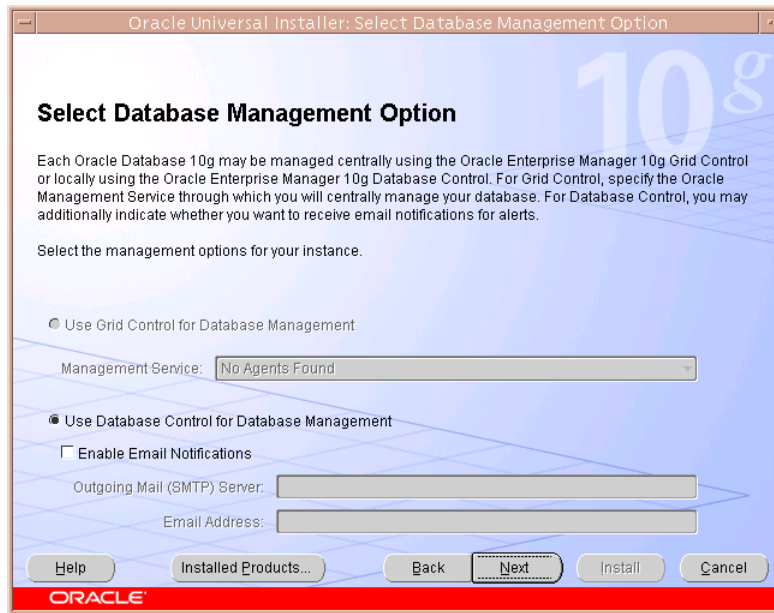
Figure 1–3 Selecting Your Management Options While Installing Oracle Database 10g

To select the Grid Control as your management option, the Oracle Management Service must be installed on a network host. In addition, the Oracle Management Agent must be installed on the host where you are installing the database. Otherwise, the Grid Control option is unavailable and you must instead choose to manage your database with the Database Control.

For most of the Oracle Database 10g installation types, you must choose either the Database Control or the Grid Control as your management option when you create a database during the installation.

However, if you create a database using one of the following methods, you can choose not to configure the Database Control:

- Choosing to create a database during a custom installation
- Choosing the Advanced database configuration option during an Enterprise or Standard Edition installation
- Running Database Configuration Assistant (DBCA) after the installation

If you do not configure the Database Control during the Oracle Database 10g installation, no *hostname_sid* directory is created in the resulting Oracle home directory (Figure 1–2).

1.2.5.2 Configuring the Database Control with DBCA

The primary method for configuring an existing Oracle Database 10g database so it can be managed with the Database Control is to use DBCA. You can use DBCA to create a new database or to reconfigure an existing database.

See Also: "Installing Oracle Software and Building the Database" in *Oracle 2 Day DBA* for more information about using DBCA to create a new database instance

To use DBCA to reconfigure your database so it can be managed with Database Control:

1. Log into the database host as a member of the administrative group that is authorized to install Oracle software and create and run the database.
2. Start DBCA, as follows:
 - On Windows, select **Start > Programs > Oracle - *home_name* > Configuration and Migration Tools > Database Configuration Assistant**.
 - On UNIX, change directory to the `ORACLE_HOME/bin` directory and enter the following command:

```
$PROMPT> ./dbca
```

The DBCA Welcome page appears.

3. Advance to the Operations page and select **Configure Database Options**.
4. Advance to the Database page and select the database you want to configure.
5. Advance to the Management Options page (Figure 1-4) and select the following options:
 - **Configure the Database with Enterprise Manager**
 - **Use Database Control for Database Management**
6. Optionally, select the options for enabling email notifications and enabling daily backups.

For more information about Enterprise Manager notifications and daily backups, click **Help** on the Management Options page.

7. Advance until the **Finish** button is available.
8. Click **Finish** to reconfigure the database so it uses Database Control.

After DBCA reconfigures the database, a new subdirectory appears in the Oracle home. This directory is named using the following format and contains Database Control configuration and state files specific to the database you just configured:

```
hostname_sid
```

For example:

```
mgmthost1.acme.com_myNewDB
```

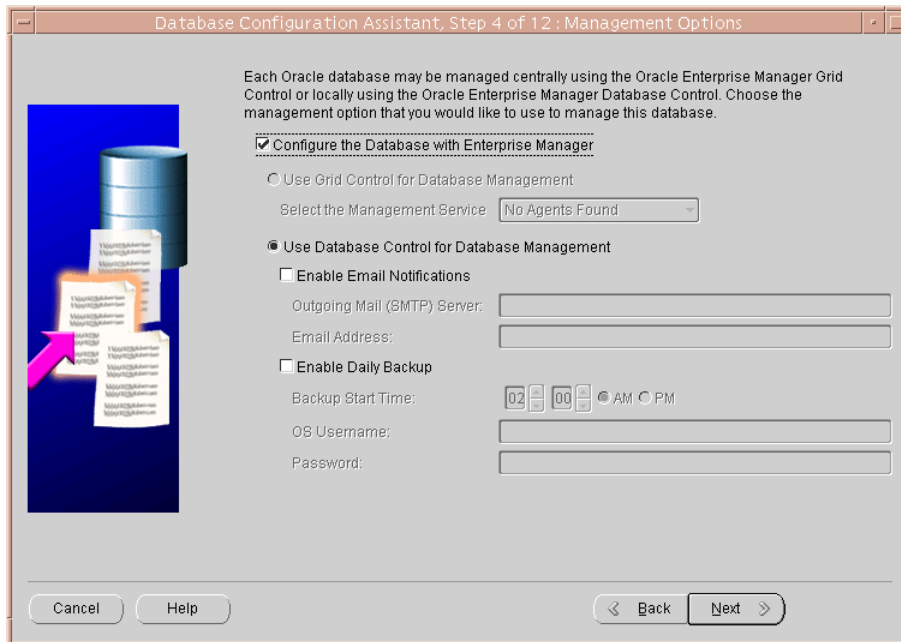
Figure 1–4 Management Options Page in DBCA

1.2.5.3 Configuring the Database Control with EMCA

When you use DBCA to configure Oracle Database 10g, DBCA provides a graphical user interface to help you select the Database Control options and to configure other aspects of your database.

However, if you want to use the operating system command-line to configure the Database Control, you can use the Enterprise Manager Configuration Assistant (EMCA).

To configure Database Control with EMCA:

1. Set the following environment variables to identify the Oracle home and the system identifier (SID) for the database you want to manage:
 - ORACLE_HOME
 - ORACLE_SID
2. Change directory to the ORACLE_HOME/bin directory.
3. Start EMCA by entering the following command with any of the optional command-line arguments shown in [Table 1–3](#):

```
$PROMPT> ./emca
```

Depending upon the arguments you include on the EMCA command line, EMCA prompts you for the information required to configure the Database Control.

For example, enter the following command to configure the Database Control so it will perform automatic daily backups of your database:

```
$PROMPT> ./emca -b
```

Table 1–3 EMCA Command-Line Arguments

Argument	Description
-a	Use this option to configure the Database Control when you are using Automatic Storage Management to store the database files.
-b	Use this option to specify the automatic daily backup options. If you use this argument, EMCA prompts you for default backup settings that Enterprise Manager uses to automatically back up your critical database files. Note: If you use this option, EMCA will use the value of the <code>db_recovery_file_dest</code> initialization parameter to identify the flashback recovery area for the automated backups. If that parameter is not set, EMCA will generate an error when you use the <code>-b</code> option. You can modify these settings later using the Maintenance page in the Database Control. For more information, see the Database Control online help.
-c	Use this option to configure the Database Control for a clustered database, as opposed to a single-instance database.
-e <i>node_name</i>	Use this option to remove the Database Control for a specified node in a clustered database. Running the <code>emca</code> command does not remove the instance; it only removes the Database Control so you will no longer be able to manage the instance with Enterprise Manager. When removing the Database Control from a node, be sure to run the <code>emca</code> command before you delete the instance, and be sure to run the command from an different node and not the node from which you are removing the Database Control. Note that this option can be used only in a Real Application Clusters environment so you do not need to use the <code>-c</code> option on the command line.
-f <i>input_file_path</i>	Use this option to specify the path to an input file for EMCA to use as it configures the Database Control. For more information, see "Using an Input File for EMCA Parameters" on page 1-12.
-h	Use this option to display the online help for the EMCA utility. The help screens lists the options described in this table, as well as the parameters you will be prompted for, based on the options you select at the command line.
-m	Use this option to configure the database so it can be centrally managed by the Oracle Enterprise Manager 10g Grid Control. To use this option, you must have previously installed the Oracle Management Service component of Enterprise Manager on a network host. In addition, the Oracle Management Agent must be installed on the host where you are installing the database.
-n <i>node_name</i>	Use this option to configure the Database Control for the specified node in a clustered database. Running the <code>emca</code> command does not create the instance; it only configures the Database Control so you can manage the instance with Enterprise Manager. When configuring the Database Control for a node, be sure to run the <code>emca</code> command after you create the instance and be sure to run the command from an existing node and not the newly created instance for which you are configuring the Database Control. Note that this option can be used only in a Real Application Clusters environment so you do not need to use the <code>-c</code> option on the command line.

Table 1–3 (Cont.) EMCA Command-Line Arguments

Argument	Description
-r	When you use this option, EMCA configures the database so it uses the Database Control, but it does not create the Management Repository. Use this option when the Management Repository has been created, but the Database Control has not been configured.
-s	Use this option to run EMCA in silent mode. EMCA will perform the operations without prompting for additional information. This option requires that you enter each of the required parameters on the command line, or that you enter the required parameters in an input file, using the -f argument on the emca command line. You can view a list of the available parameters by entering <code>emca -h</code> at the command line.
-x <i>SID</i> -x <i>DB_name</i>	Use this option to remove the Database Control for the specified database. For example, you might use this argument to remove the Database Control from a database you are planning to delete. In such a scenario, you should remove the Database Control before the database is physically deleted. Note that this option deletes only the Database Control for the database. It does not remove the database or any data files. When you use this argument in a Real Application Clusters environment, you must use it with the -c option and you should provided the name of the database and not the SID. For example: <code>\$PROMPT> ./emca -c -x CRSdb42</code>

1.2.5.4 Using an Input File for EMCA Parameters

Instead of answering a series of prompts when you run EMCA, you can use the -f argument to specify an input file. The input file you create must be in a format similar to the following example:

```
EM_HOME=/private/oraclehome
ORACLE_HOME=/private/oraclehome
PORT=1521
SID=DB
HOST=mgmthost1
DBSNMP_PWD=xpE234D
SYSMAN_PWD=KD0dk432
```

After you create an EMCA input file, you can use it on the command line as follows:

```
$PROMPT> ./emca -f input_file_path
```

For example, to configure the Database Control to perform daily backups, create an input file similar to the one shown in [Example 1–1](#) and enter the following command at the operating system prompt:

```
$PROMPT> ./emca -b -f input_file_path
```

Example 1–1 EMCA Input File that Configures the Database Control for Automatic Backup and Creates the Management Repository

```
EM_HOME=/private/oraclehome
ORACLE_HOME=/private/oraclehome
PORT=1521
SID=DB
```

```

HOST=mgmthost2
DBSNMP_PWD=dow31224
SYSMAN_PWD=squN3243
HOST_USER=johnson
HOST_USER_PWD=diTf32of
BACKUP_HOUR=5
BACKUP_MINUTE=5
NO_ARCHIVE=YES
LISTENER=LISTENER
SYS_PWD=q1Kj4352

```

1.2.5.5 Using EMCA with Real Application Clusters

Oracle Real Application Clusters provides a high availability database environment spanning multiple hosts. Each cluster may be made up of multiple cluster databases, each of which consists of multiple cluster database instances. A cluster database is available as long as one of its instances is available.

When you use EMCA to configure the Database Control for Real Application Clusters, you configure the Database Control for each instance in the cluster. After you create a new instance, you can run EMCA to configure a Database Control for that instance.

The following arguments to the EMCA command line utility can be used in a Real Application Clusters environment:

- `emca -c`, which you use to identify the fact that you are using EMCA in a Real Application Clusters environment. For example, enter `emca -c` to configure a Real Application Clusters database, create the Management Repository without enabling automatic daily backups. This option is also required when you are removing the Database Control with the `-x` option.
- `emca -e`, which you use to remove the Database Control for a specified node.
- `emca -n`, which you use to configure the Database Control for a specified node.
- `emca -x`, which you use to remove the Database Control from a specified database.

For more information, see [Table 1-3](#), which describes each of the EMCA command-line options.

1.2.5.6 EMCA Troubleshooting Tips

Sometimes, if you create a custom database and later use EMCA to add the capability to manage the database with the Database Control, you receive the following error:

```

Repository already exists. Fix the error(s) and run EM configuration assistant
again.

```

This error is generated when EMCA discovers that the SYSMAN database user and a corresponding Oracle Management Repository already exists in the database. As a result, EMCA is unable to create a new Oracle Management Repository for the Database Control.

You can work around this problem in the following ways:

- If the database has been upgraded to Oracle Database 10g and it contains a previous version of the Oracle Management Repository, drop the existing repository and run EMCA again to create a new Oracle Management Repository for Oracle Database 10g.

- If the database has not been upgraded, the problem is often caused by the fact that the custom database you created automatically included the Oracle Management Repository schema.

To work around this problem, use the `-r` argument on the EMCA command line to prevent EMCA from creating the Management Repository:

```
$PROMPT> ./emca -r
```

1.3 Starting and Stopping Enterprise Manager Components

To start and stop the Management Service, the Management Agent, the Grid Control, the Application Server Control, and the Database Control, you use the Enterprise Manager command-line utility (`emctl`).

The capabilities of the command-line utility can be broken down into the following categories:

- [Controlling the Oracle Management Agent](#)
- [Controlling the Oracle Management Service](#)
- [Controlling the Application Server Control](#)
- [Controlling the Database Control on UNIX](#)
- [Starting and Stopping the Oracle Enterprise Manager 10g Grid Control Framework](#)

1.3.1 Controlling the Oracle Management Agent

The following sections describe how to use the Enterprise Manager command-line utility (`emctl`) to control the Oracle Management Agent:

- [Starting, Stopping, and Checking the Status of the Management Agent on UNIX](#)
- [Starting and Stopping the Management Agent on Windows](#)
- [Checking the Status of the Management Agent on Windows](#)

1.3.1.1 Starting, Stopping, and Checking the Status of the Management Agent on UNIX

To start, stop, or check the status of the Management Agent on UNIX systems:

1. Change directory to the `AGENT_HOME/bin` directory.
2. Use the appropriate command described in [Table 1-4](#).

For example, to stop the Management Agent, enter the following commands:

```
$PROMPT> cd AGENT_HOME/bin
$PROMPT> ./emctl stop agent
```

Table 1-4 Starting, Stopping, and Checking the Status of the Management Agent

Command	Purpose
<code>emctl start agent</code>	Starts the Management Agent
<code>emctl stop agent</code>	Stops the Management Agent

Table 1–4 (Cont.) Starting, Stopping, and Checking the Status of the Management Agent

Command	Purpose
emctl status agent	If the Management Agent is running, this command displays status information about the Management Agent, including the Agent Home, the process ID, and the time and date of the last successful upload to the Management Repository (Example 1–2).

Example 1–2 Checking the Status of the Management Agent

```

$PROMPT> ./emctl status agent
Oracle Enterprise Manager 10g Release 10.1.0.2.0
Copyright (c) 2002, 2003 Oracle Corporation. All rights reserved.
-----
Version           : 10.1.0.2.0
Agent Home        : /private/oracle/EM_40_SH10/agent
Agent Process ID  : 8102
Parent Process ID : 8095
Agent URL         : http://usunnab08.us.oracle.com:1813/emd/main/
Started at       : 2003-01-29 12:11:39
Started by user   : oracle
Last Reload      : 2003-01-29 12:45:10
Last successful upload          : 2003-01-30 11:08:27
Total Megabytes of XML files uploaded so far :    25.21
Number of XML files pending upload           :         0
Size of XML files pending upload(MB)        :         0.00
Available disk space on upload filesystem    :    76.87%
-----
Agent is Running and Ready
$PROMPT>

```

1.3.1.2 Starting and Stopping the Management Agent on Windows

To start or stop the Management Agent on Windows systems:

1. Open the Services control panel.

For example, on Windows NT, select **Start > Settings > Control Panel** and then double-click the Services icon.

On Windows 2000, select **Start > Administrative Tools > Services**.

2. Locate the Management Agent in the list of services.

The name of the service is usually consists of "Oracle," followed by the name of the home directory you specified during the installation, followed by the word "Agent." For example, if you specified `em10g` as the Oracle Home, the Service name would be:

```
OracleORACLEem10gAgent
```

3. After you locate the service, you can use the Services control panel to start or stop the Management Agent service.

By default, the Management Agent service is configured to start automatically when the system starts.

1.3.1.3 Checking the Status of the Management Agent on Windows

To check the status of the Management Agent on Windows systems:

1. Change directory to the following location in the AGENT_HOME directory:

```
AGENT_HOME/bin
```

2. Enter the following emctl command to check status of the Management Agent:

```
$PROMPT> ./emctl status agent
```

If the Management Agent is running, this command displays status information about the Management Agent, including the Agent Home, the process ID, and the time and date of the last successful upload to the Management Repository (Example 1–2).

1.3.2 Controlling the Oracle Management Service

There are two methods for starting and stopping the Oracle Management Service.

1.3.2.1 Using OPMN to Start and Stop the Management Service

One method is to start and stop the Management Service by using the Oracle Process Management and Notification (OPMN) utility. The OPMN utility (`opmnctl`) is a standard command used to start and stop components of the Oracle Application Server instance.

The Management Service is a J2EE application running in an Oracle Application Server Containers for J2EE (OC4J) instance within the application server. As a result, the following command will start all the components of the Oracle Application Server instance, including the OC4J_EM instance and the Management Service application:

```
$PROMPT> cd opmn/bin  
$PROMPT> ./opmnctl startall
```

Similarly, the following command will stop all the components of the Oracle Application Server instance:

```
$PROMPT> ./opmnctl stopall
```

If you want to start only the components necessary to run the Management Service, you can use the Enterprise Manager command-line utility.

1.3.2.2 Using emctl to Start, Stop, and Check the Status of the Oracle Management Service

To start, stop, or check the status of the Management Service with the Enterprise Manager command-line utility:

1. Change directory to the `ORACLE_HOME/bin` directory in the Management Service home.
2. Use the appropriate command described in [Table 1–5](#).

For example, to stop the Management Agent, enter the following commands:

```
$PROMPT> cd bin  
$PROMPT> ./emctl stop oms
```

Table 1–5 Starting, Stopping, and Checking the Status of the Management Service

Command	Purpose
emctl start oms	Starts the Oracle Application Server components required to run the Management Service J2EE application. Specifically, this command starts OPMN, the Oracle HTTP Server, and the OC4J_EM instance where the Management Service is deployed. Note: The <code>emctl start oms</code> command does not start Oracle Application Server Web Cache. For more information, see "Starting and Stopping Oracle Application Server Web Cache" on page 1-17.
emctl stop oms	Stops the Management Service. Note that this command does not stop the other processes that are managed by the Oracle Process Manager and Notification (OPMN) utility. To stop the other Oracle Application Server components, such as the Oracle HTTP Server and Oracle Application Server Web Cache, see "Starting and Stopping the Oracle Enterprise Manager 10g Grid Control Framework" on page 1-19.
emctl status oms	Displays a message indicating whether or not the Management Service is running.

1.3.2.3 Starting and Stopping Oracle Application Server Web Cache

By default, when you install Oracle Enterprise Manager 10g, the Grid Control is configured to use Oracle Application Server Web Cache.

See Also: *Oracle Application Server Web Cache Administrator's Guide* for more information about Oracle Application Server Web Cache

Oracle Application Server Web Cache not only improves the performance of the Grid Control, but also makes it possible to measure the end-user performance of the Enterprise Manager Web application.

See Also: [Chapter 4, "Configuring Application Performance Management"](#) for more information about End-User Performance Monitoring and the Enterprise Manager Web Application

To view the Grid Control using Oracle Application Server Web Cache, you access the Grid Control using the standard port number assigned during the Oracle Enterprise Manager 10g installation procedure. You can find this default port number (usually 7777) in the `setupinfo.txt` file, which is copied to the following directory during the Enterprise Manager installation procedure:

```
AS_HOME/Apache/Apache
```

If Oracle Application Server Web Cache is not running, you will receive an error message, such as the following, if you try to access the Grid Control using the default port number:

```
HTTP 500 - Internal server error
```

To start Oracle Application Server Web Cache:

1. Change directory to the `ORACLE_HOME/opmn/bin` directory in the Management Service home.

- Use the appropriate command described in [Table 1–6](#).

For example, to stop Oracle Application Server Web Cache, enter the following commands:

```
$PROMPT> cd opmn/bin
$PROMPT> ./opmnctl stopproc ias-component=WebCache
```

Table 1–6 Starting, Stopping, and Checking the Status of Oracle Application Server Web Cache

Command	Purpose
<code>opmnctl startproc ias-component=WebCache</code>	Starts Oracle Application Server Web Cache.
<code>opmnctl stopproc ias-component=WebCache</code>	Stops Oracle Application Server Web Cache.
<code>opmnctl status</code>	Displays a message showing the status of all the application server components managed by OPMN, including Oracle Application Server Web Cache.

1.3.3 Controlling the Application Server Control

The Application Server Control is a component of Oracle Enterprise Manager 10g that is installed as part of any Oracle Application Server installation. To control the Application Server Control, you use the `emctl` command-line utility that is available in the `IAS_HOME/bin` directory after you install Oracle Application Server.

To start the Application Server Control, change directory to the `IAS_HOME/bin` directory and then enter the following command:

```
$PROMPT> ./emctl start iasconsole
```

To stop the Application Server Control, enter the following command:

```
$PROMPT> ./emctl stop iasconsole
```

See Also: *Oracle Application Server 10g Administrator's Guide* for more information about using `emctl` to control the Application Server Control and for information on starting and stopping the Application Server Control on Windows

1.3.4 Controlling the Database Control on UNIX

The Oracle Enterprise Manager Database Control is a component of Oracle Enterprise Manager 10g that is installed as part of any Oracle Database 10g installation.

To control the Database Control, you use the `emctl` command-line utility that is available in the `ORACLE_HOME/bin` directory after you install Oracle Database 10g.

1.3.4.1 Starting the Database Control on UNIX

To start the Database Control, as well the Management Agent and the Management Service associated with the Database Control:

- Set the following environment variables to identify the Oracle home and the system identifier (SID) for the database instance you want to manage:
 - ORACLE_HOME

- ORACLE_SID
2. Change directory to the ORACLE_HOME/bin directory.
 3. Enter the following command:

```
$PROMPT> ./emctl start dbconsole
```

1.3.4.2 Stopping the Database Control on UNIX

To stop the Database Control, as well the Management Agent and the Management Service associated with the Database Control:

1. Set the following environment variables to identify the Oracle home and the system identifier (SID) for the database instance you want to manage:
 - ORACLE_HOME
 - ORACLE_SID
2. Change directory to the ORACLE_HOME/bin directory.
3. Enter the following command:

```
$PROMPT> ./emctl stop dbconsole
```

1.3.5 Starting and Stopping the Oracle Enterprise Manager 10g Grid Control Framework

As described in the previous sections, you use separate commands to control the Oracle Management Service, Oracle Management Agent, and the Oracle Application Server components on which the Grid Control Framework depends.

The following sections describe how to stop and start all the Grid Control Framework components that are installed by the Oracle Enterprise Manager 10g Grid Control installation procedure.

You can use this procedure to start all the framework components after a system reboot or to shutdown all the components before bringing the system down for system maintenance.

1.3.5.1 Starting the Grid Control Framework

The following procedure summarizes the steps required to start all the components of the Grid Control Framework. For example, use this procedure if you have restarted the host computer and all the components of the Grid Control Framework have been installed on that host.

To start all the Grid Control Framework components on a host, use the following procedure:

1. If your Oracle Management Repository resides on the host, change directory to the Oracle Home for the database where you installed the Management Repository and start the database and the Net Listener for the database:
 - a. Set the ORACLE_HOME environment variable to the Management Repository database home directory.
 - b. Set the ORACLE_SID environment variable to the Management Repository database SID (default is asdb).
 - c. Start the Net Listener:

```
$PROMPT> $ORACLE_HOME/bin/lsnrctl start
```

- d. Start the Management Repository database instance:

```
ORACLE_HOME/bin/sqlplus /nolog
SQL> connect SYS as SYSDBA
SQL> startup
SQL> quit
```

See Also: *Oracle Database Administrator's Guide* for information about starting and stopping an Oracle Database

2. Start the Oracle Management Service:

```
$PROMPT> ORACLE_HOME/bin/emctl start oms
```

See Also: ["Controlling the Oracle Management Service"](#) on page 1-16

3. Start OracleAS Web Cache:

```
$PROMPT> $ORACLE_HOME/opmn/bin/opmnctl startproc -ias-component=WebCache
```

4. Start the Application Server Control, which is used to manage the Oracle Application Server instance:

```
$PROMPT> $ORACLE_HOME/bin/emctl start iasconsole
```

See Also: ["Controlling the Application Server Control"](#) on page 1-18

5. Change directory to the home directory for the Oracle Management Agent and start the Management Agent:

```
$PROMPT> AGENT_HOME/bin/emctl start agent
```

See Also: ["Controlling the Oracle Management Agent"](#) on page 1-14

Note: Be sure to run the `emctl start agent` command in the Oracle Management Agent home directory and not in the Management Service home directory.

1.3.5.2 Stopping the Grid Control Framework

The following procedure summarizes the steps required to stop all the components of the Grid Control Framework. For example, use this procedure if you have installed all the components of the Grid Control Framework on the same host you want to shut down or restart the host computer.

To stop all the Grid Control Framework components on a host, use the following procedure:

1. Stop the Oracle Management Service:

```
$PROMPT> $ORACLE_HOME/bin/emctl stop oms
```

See Also: ["Controlling the Oracle Management Service"](#) on page 1-16

2. Stop the Application Server Control, which is used to manage the Oracle Application Server instance used to deploy the Management Service:

```
$PROMPT> $ORACLE_HOME/bin/emctl stop iasconsole
```

See Also: ["Controlling the Application Server Control"](#) on page 1-18

3. Stop all the Oracle Application Server components, such as the Oracle HTTP Server the OracleAS Web Cache:

```
$PROMPT> $ORACLE_HOME/opmn/bin/opmnctl stopall
```

See Also: *Oracle Application Server 10g Administrator's Guide*

4. Change directory to the home directory for the Oracle Management Agent and stop the Management Agent:

```
$PROMPT> AGENT_HOME/bin/emctl stop agent
```

See Also: ["Controlling the Oracle Management Agent"](#) on page 1-14

Note: Be sure to run the `emctl stop agent` command in the Oracle Management Agent home directory and not in the Oracle Application Server home directory.

5. If your Oracle Management Repository resides on the same host, change directory to the Oracle Home for the database where you installed the Management Repository and stop the database and the Net Listener for the database:

- a. Set the ORACLE_HOME environment variable to the Management Repository database home directory.
- b. Set the ORACLE_SID environment variable to the Management Repository database SID (default is asdb).
- c. Stop the database instance:

```
$PROMPT> ORACLE_HOME/bin/sqlplus /nolog
SQL> connect SYS as SYSDBA
SQL> shutdown
SQL> quit
```

See Also: *Oracle Database Administrator's Guide* for information about starting and stopping an Oracle Database

- d. Stop the Net Listener:

```
$PROMPT> $ORACLE_HOME/bin/lsnrctl stop
```

1.4 Additional Management Agent Commands

The following sections describe additional `emctl` commands you can use to control the Management Agent:

- [Uploading and Reloading Data to the Management Repository](#)
- [Specifying New Target Monitoring Credentials](#)

- [Listing the Targets on a Managed Host](#)
- [Controlling Blackouts](#)

1.4.1 Uploading and Reloading Data to the Management Repository

Under normal circumstances, the Management Agent uploads information about your managed targets to the Management Service at regular intervals.

However, there are two Enterprise Manager commands that can help you force an immediate upload of data to the Management Service or a reload of the target definitions and attributes stored in the Management Agent home directory.

To use these commands, change directory to the `AGENT_HOME/bin` directory (UNIX) or the `AGENT_HOME\bin` directory (Windows) and enter the appropriate command as described in [Table 1-7](#).

Table 1-7 *Manually Reloading and Uploading Management Data*

Command	Purpose
<code>emctl upload</code>	Use this command to force an immediate upload of the current management data from the managed host to the Management Service. Use this command instead of waiting until the next scheduled upload of the data.
<code>emctl reload</code>	This command is for use by Oracle Support. This command can be used when manual edits are made to the Management Agent configuration (.XML) files. For example, if changes are made to the <code>targets.xml</code> file, which defines the attributes of your managed targets, this command will upload the modified target information to the Management Service, which will then update the information in the Management Repository. Note: Oracle does not support manual editing of the <code>targets.xml</code> files unless the procedure is explicitly documented or you are instructed to do so by Oracle Support.

1.4.2 Specifying New Target Monitoring Credentials

To monitor the performance of your database targets, Enterprise Manager connects to your database using a database username and password. This username and password combination is referred to as the database monitoring credentials.

Note: The instructions in this section are specific to the monitoring credentials for a database target, but you can use this procedure for any other target type that requires monitoring credentials. For example, you can use this procedure to specify new monitoring credentials for your Oracle Management Service and Management Repository.

For more information about the monitoring credentials for the Management Repository, see "[Changing the SYSMAN Password](#)" on page 6-7.

When you first add a database target, or when it is added for you during the installation of the Management Agent, Enterprise Manager uses the DBSNMP database user account and the default password for the DBSNMP account as the monitoring credentials.

If the password for the DBSNMP database user account is changed, you must modify the properties of the database target so that Enterprise Manager can continue to connect to the database and gather configuration and performance data.

You can modify the Enterprise Manager monitoring credentials by using the Oracle Enterprise Manager 10g Grid Control or by using the Enterprise Manager command-line utility (`emctl`).

1.4.2.1 Using the Grid Control to Modify the Monitoring Credentials

To modify the password for the DBSNMP account in the Oracle Enterprise Manager 10g Grid Control:

1. Click the **Targets** tab in the Grid Control.
2. Click the **Database** subtab to list the database targets you are monitoring.
3. Select the database and click **Configure**.
Enterprise Manager displays the Configure Database: Properties page.
4. Enter the new password for the DBSNMP account in the **Monitor Password** field.
5. Click **Test Connection** to confirm that the monitoring credentials are correct.
6. If the connection is successful, continue to the end of the Database Configuration wizard and click **Submit**.

1.4.2.2 Using the Enterprise Manager Command Line to Modify the Monitoring Credentials

To enter new monitoring credentials with the Enterprise Manager command-line utility:

1. Change directory to the `AGENT_HOME/bin` directory (UNIX) or the `AGENT_HOME\bin` directory (Windows).
2. Enter the following command to specify new monitoring credentials:
`$PROMPT>./emctl config agent credentials [Target_name[:Target_Type]]`

To determine the correct target name and target type, see "[Listing the Targets on a Managed Host](#)" on page 1-23.

[Example 1-3](#) shows an example of the prompts and the output you receive from the command.

Example 1-3 Modifying the Database Monitoring Credentials

```
$PROMPT>./emctl config agent credentials emrep10.acme.com:oracle_database
Oracle Enterprise Manager 10g Release 10.1.0.2.0
Copyright (c) 2002, 2003 Oracle Corporation. All rights reserved.
Name = emrep10.us.oracle.com, Type = oracle_database
Want to change for "UserName" (y/n):n
Want to change for "password" (y/n):y
Enter the value for "password" :*****
EMD reload completed successfully
```

1.4.3 Listing the Targets on a Managed Host

There are times when you need to provide the name and type of a particular target you are managing. For example, you must know the target name and type when you are setting the monitoring credentials for a target.

To list the name and type of each target currently being monitored by a particular Management Agent:

1. Change directory to the `AGENT_HOME/bin` directory (UNIX) or the `AGENT_HOME\bin` directory (Windows).
2. Enter the following command to specify new monitoring credentials:

```
$PROMPT>./emctl config agent listtargets [AGENT_HOME]
```

[Example 1-4](#) shows the typical output of the command.

Example 1-4 Listing the Targets on a Managed Host

```
./emctl config agent listtargets
Oracle Enterprise Manager 10g Release 10.1.0.2.0
Copyright (c) 2002, 2003 Oracle Corporation. All rights reserved.
[usunnab08.us.oracle.com, host]
[LISTENER_usunnab08.us.oracle.com, oracle_listener]
[EnterpriseManager.usunnab08.us.oracle.com_HTTP Server, oracle_apache]
[EnterpriseManager.usunnab08.us.oracle.com_home, oc4j]
[EnterpriseManager.usunnab08.us.oracle.com_Web Cache, oracle_webcache]
[EnterpriseManager.usunnab08.us.oracle.com, oracle_ias]
[EnterpriseManager.usunnab08.us.oracle.com_OC4J_EM, oc4j]
[EnterpriseManager.usunnab08.us.oracle.com_OC4J_Demos, oc4j]
[EM_Repository, oracle_emrep]
[usunnab08.us.oracle.com:1813, oracle_emd]
[EM Website, website]
[emrep10.us.oracle.com, oracle_database]
```

1.4.4 Controlling Blackouts

Blackouts allow Enterprise Manager users to suspend management data collection activity on one or more managed targets. For example, administrators use blackouts to prevent data collection during scheduled maintenance or emergency operations.

See Also: The "Systems Monitoring" chapter in Oracle Enterprise Manager Concepts for more information about Enterprise Manager blackouts

You can control blackouts from the Oracle Enterprise Manager 10g Grid Control or from the Enterprise Manager command-line utility (`emctl`). However, if you are controlling target blackouts from the command line, you should not attempt to control the same blackouts from the Grid Control. Similarly, if you are controlling target blackouts from the Grid Control, do not attempt to control those blackouts from the command line.

See Also: "Creating, Editing, and Viewing Blackouts" in the Enterprise Manager online help for information about controlling blackouts from the Grid Control

From the command line, you can perform the following blackout functions:

- Starting Immediate Blackouts
- Stopping Immediate Blackouts
- Checking the Status of Immediate Blackouts

Note: When you start a blackout from the command line, any Enterprise Manager jobs scheduled to run against the blacked out targets will still run. If you use the Grid Control to control blackouts, you can optionally prevent jobs from running against blacked out targets.

To use the Enterprise Manager command-line utility to control blackouts:

1. Change directory to the AGENT_HOME/bin directory (UNIX) or the AGENT_HOME\bin directory (Windows).
2. Enter the appropriate command as described in [Table 1-8](#).

Note: When you start a blackout, you must identify the target or targets affected by the blackout. To obtain the correct target name and target type for a target, see "[Listing the Targets on a Managed Host](#)" on page 1-23.

Table 1-8 Summary of Blackout Commands

Blackout Action	Command
Set an immediate blackout on a particular target or list of targets	<pre>emctl start blackout <Blackoutname> [<Target_name>[:<Target_Type>]]... [-d <Duration>]</pre> <p>Be sure to use a unique name for the blackout so you can refer to it later when you want to stop or check the status of the blackout.</p> <p>The -d option is used to specify the duration of the blackout. Duration is specified in [days] hh:mm where:</p> <ul style="list-style-type: none"> ■ days ■ indicates number of days, which is optional ■ hh ■ indicates number of hours ■ mm ■ indicates number of minutes <p>If you do not specify a target or list of targets, Enterprise Manager will blackout the local host target. All monitored targets on the host are not blacked out unless a list is specified or you use the -nodeLevel argument, which is described below.</p> <p>If two targets of different target types share the same name, you must identify the target with its target type.</p>
Stop an immediate blackout	<pre>emctl stop blackout <Blackoutname></pre>
Set an immediate blackout for all targets on a host	<pre>emctl start blackout <Blackoutname> [-nodeLevel] [-d <Duration>]</pre> <p>The -nodeLevel option is used to specify a blackout for all the targets on the host; in other words, all the targets that the Management Agent is monitoring, including the Management Agent host itself. The -nodeLevel option must follow the blackout name. If you specify any targets after the -nodeLevel option, the list is ignored.</p>
Check the status of a blackout	<pre>emctl status blackout [<Target_name>[:<Target_Type>]]...</pre>

Use the following examples to learn more about controlling blackouts from the Enterprise Manager command line:

- To start a blackout called "bk1" for databases "db1" and "db2," and for Oracle Listener "ldb2," enter the following command:

```
$PROMPT> emctl start blackout bk1 db1 db2 ldb2:oracle_listener -d 5 02:30
```

The blackout starts immediately and will last for 5 days 2 hours and 30 minutes.

- To check the status of all the blackouts on a managed host:

```
$PROMPT> emctl status blackout
```

- To stop blackout "bk2" immediately:

```
$PROMPT> emctl stop blackout bk2
```

- To start an immediate blackout called "bk3" for all targets on the host:

```
$PROMPT> emctl start blackout bk3 -nodeLevel
```

- To start an immediate blackout called "bk3" for database "db1" for 30 minutes:

```
$PROMPT> emctl start blackout bk3 db1 -d 30
```

- To start an immediate blackout called "bk3" for database "db2" for five hours:

```
$PROMPT> emctl start blackout bk db2 -d 5:00
```

1.5 Enabling Enterprise Manager Accessibility Features

As part of the effort to make Oracle products, services, and supporting documentation accessible and usable to the disabled community, Enterprise Manager offers several features that make management data available to users of assistive technology.

To enable these features and provide for full accessibility, you must modify two configuration settings, which are described in the following sections:

- [Enabling Enterprise Manager Accessibility Mode](#)
- [Providing Textual Descriptions of Enterprise Manager Charts](#)

1.5.1 Enabling Enterprise Manager Accessibility Mode

Enterprise Manager takes advantage of user interface development technologies that improve the responsiveness some user operations. For example, when you navigate to a new record set in a table, Enterprise Manager does not redisplay the entire HTML page.

However, this performance-improving technology is generally not supported by screen readers. To disable this feature, and as a result, make the Enterprise Manager HTML pages more accessible for disabled users, use the following procedure.

Note: The following procedure is valid for both Grid Control and Database Control installations. Differences in the location of configuration files is noted where applicable.

For information on enabling accessibility for the Application Server Control, see "Managing and Configuring the Application Server Control" in the *Oracle Application Server 10g Administrator's Guide*.

1. Locate the `uix-config.xml` configuration file.

To locate the `uix-config.xml` file in a Grid Control installation, change directory to the following location in the Management Service home:

```
ORACLE_HOME/j2ee/OC4J_EM/applications/em/em/WEB-INF (Grid Control)
```

To locate the `uix-config.xml` file in a Oracle Database 10g installation, change directory to the following location in the database home:

```
ORACLE_HOME/oc4j/j2ee/oc4j_applications/applications/em/em/WEB-INF (Database Control)
```

2. Open the `uix-config.xml` file using a text editor and locate the following entry:

```
<!-- An alternate configuration that disables accessibility features -->
<default-configuration>
  <accessibility-mode>inaccessible</accessibility-mode>
</default-configuration>
```

3. Change the value of the `accessibility-mode` property from `inaccessible` to `accessible`.
4. Save and close the file.
5. Restart the Oracle Management Service (if you are modifying a Grid Control installation) or restart the Database Control (if you are modifying an Oracle Database 10g installation).

1.5.2 Providing Textual Descriptions of Enterprise Manager Charts

Throughout Enterprise Manager, charts are used to display performance data. For most users, these charts provide a valuable graphical view of the data that can reveal trends and help identify minimum and maximum values for performance metrics.

However, charts do not convey information in a manner that can be read by a screen reader. To remedy this problem, you can configure Enterprise Manager to provide a complete textual representation of each performance chart. By default, support for the textual representation of charts is disabled. When textual description for charts is enabled, Enterprise Manager displays a small icon for each chart that can be used as a drill-down link to the textual representation.

Figure 1–5 shows an example of the icon that displays beneath Enterprise Manager charts when you have enabled the textual representation of charts.

Figure 1–5 Icon Representing the Textual Representation of a Chart

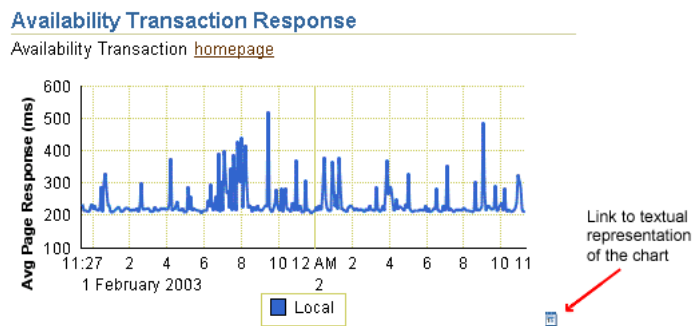

To enable the drill-down icon for the textual representation of charts:

1. Locate the `web.xml` configuration file.

To locate the `web.xml` file in a Grid Control installation, change directory to the following location in the Management Service home:

```
ORACLE_HOME/j2ee/OC4J_EM/applications/em/em/WEB-INF
```

To locate the `web.xml` file in a Oracle Database 10g installation, change directory to the following location in the database home:

```
ORACLE_HOME/oc4j/j2ee/oc4j_applications/applications/em/em/WEB-INF
```

2. Open the `web.xml` file with your favorite text editor and locate the following six lines of the file:

```
<!-- Uncomment this to enable textual chart descriptions
<context-param>
<param-name>enableChartDescription</param-name>
<param-value>true</param-value>
</context-param>
-->
```

3. Uncomment this section by deleting the first line and the last line of this section so that the section consists of only these 4 lines:

```
<context-param>
<param-name>enableChartDescription</param-name>
<param-value>true</param-value>
</context-param>
```

4. Save and exit the file.
5. Restart the Management Service (if you are modifying a Grid Control installation) or restart the Database Control (if you are modifying an Oracle Database 10g installation).

Enterprise Manager Security

This chapter describes how to configure Oracle Enterprise Manager Security. Specifically, this chapter contains the following sections:

- [About Oracle Enterprise Manager Security](#)
- [Configuring Security for the Grid Control Framework](#)
- [Configuring Security for the Enterprise Manager Application Server Control](#)
- [Configuring Security for the Oracle Enterprise Manager 10g Database Control](#)
- [Configuring Enterprise Manager for Use with Oracle Application Server Single Sign-On](#)
- [Configuring Enterprise Manager for Use with Enterprise User Security](#)
- [Additional Security Considerations](#)

2.1 About Oracle Enterprise Manager Security

Oracle Enterprise Manager provides tools and procedures to help you ensure that you are managing your Oracle environment in a secure manner. Oracle Enterprise Manager security can be divided into these categories:

- Security for the Oracle Enterprise Manager 10g Grid Control
- Security for the Oracle Enterprise Manager 10g Application Server Control

See Also: *Oracle Application Server 10g Administrator's Guide* for information about securing the Oracle Enterprise Manager 10g Application Server Control

- Security for the Oracle Enterprise Manager 10g Database Control

The following sections describe the security features that apply to these categories.

2.1.1 Oracle Enterprise Manager Security Model

The goals of Oracle Enterprise Manager security are:

- To be sure that only users with the proper privileges have access to critical monitoring and administrative data.

This goal is met by requiring username and password credentials before users can access the Enterprise Manager consoles. This includes access to the Oracle Enterprise Manager 10g Grid Control, the Oracle Enterprise Manager 10g

Database Control, and the Oracle Enterprise Manager 10g Application Server Control.

- To be sure that all data transferred between Enterprise Manager components is transferred in a secure manner and that all data gathered by each Oracle Management Agent can be transferred only to the Oracle Management Service for which the Agent is configured.

This goal is met by enabling Enterprise Manager Framework Security. Enterprise Manager Framework Security automates the process of securing the Enterprise Manager components installed and configured on your network.

See Also: ["About Enterprise Manager Framework Security"](#) on page 2-4

2.1.2 Classes of Users and Their Privileges

Oracle Enterprise Manager supports different classes of Oracle users, depending upon the environment you are managing and the context in which you are using Oracle Enterprise Manager 10g.

The types of users supported by Enterprise Manager vary depending upon the Enterprise Manager product you are using. For example:

- The Grid Control provides support for creating and managing Enterprise Manager administrator accounts.

The Enterprise Manager administrators you create and manage in the Grid Control are granted privileges and roles to log in to the Grid Control and to manage specific target types and to perform specific management tasks.

The default super administrator for the Grid Control is the SYSMAN user, which is a database user associated with the Oracle Management Repository. You define the password for the SYSMAN account during the Enterprise Manager installation procedure.

- Oracle Application Server administrators use the Oracle Application Server administrator account (`ias_admin`) to log in to the Application Server Control.
- You use the `ias_admin` account to manage the components of a specific Oracle Application Server instance. You define the password for the `ias_admin` account during the Oracle Application Server installation procedure.
- Oracle Database 10g administrators can use the SYS, SYSTEM, or SYSMAN database user accounts to log in to the Database Control.

The SYSMAN database user is the default super administrator for managing Oracle Database 10g. You define the password for the SYSMAN account during the Oracle Database 10g installation procedure.

2.1.3 Resources Protected

By restricting access to privileged users and providing tools to secure communications between Oracle Enterprise Manager 10g components, Enterprise Manager protects critical information in the Oracle Management Repository.

The Management Repository contains management data that Enterprise Manager uses to help you monitor the performance and availability of your entire enterprise. This data provides you with information about the types of hardware and software you have deployed, as well as the historical performance and specific characteristics of the applications, databases, applications servers, and other targets that you manage.

The Management Repository also contains information about the Enterprise Manager administrators who have the privileges to access the management data.

2.1.4 Authorization and Access Enforcement

Authorization and access enforcement for Enterprise Manager is controlled as follows:

- When you use the Grid Control, you create and manage Enterprise Manager administrator accounts. The SYSMAN super administrator can assign specific privileges and roles to each of the additional administrators. These privileges and roles control the targets an administrator can manage and the specific types of tasks the administrator can perform.

See Also: "About Administrators and Roles" in the Enterprise Manager online help

- When you use the Application Server Control, access to the Console is restricted to administrators who use the `ias_admin` administrator's account. The `ias_admin` account is set up automatically and you assign a password for the account during the Oracle Application Server installation procedure.

See Also: *Oracle Application Server 10g Administrator's Guide* for more information about the `ias_admin` account

- When you use the Oracle Enterprise Manager 10g Database Control, access and authorization for the Database Control is limited to specific database users who have been granted management privileges by the SYS, SYSTEM, or SYSMAN user.

See Also: "About Administrators and Roles" in the Enterprise Manager online help

2.1.5 Leveraging Oracle Application Server Security Services

As a Web-based application, Enterprise Manager relies on industry-standard technologies to provide secure access to the Oracle Enterprise Manager 10g Grid Control, Database Control, and Application Server Control.

When you configure security for the Oracle Enterprise Manager 10g Grid Control, Enterprise Manager Framework Security provides secure communications between the components of your Enterprise Manager installation. However, you should also use the security services of your Oracle HTTP Server to be sure access to the Grid Control is secure.

See Also: "[Configuring Security for the Grid Control Framework](#)" on page 2-4 for more information about the Enterprise Manager Framework Security

Oracle HTTP Server Administrator's Guide for information about configuring security for your Oracle HTTP Server.

Enterprise Manager deploys the Application Server Control and Database Control within a single, standalone Oracle Application Server Containers for J2EE (OC4J) instance. As a result, when you configure security for the Application Server Control, or for the Database Control, Enterprise Manager uses the standard security services of OC4J to protect your management data.

See Also: ["Configuring Security for the Enterprise Manager Application Server Control"](#) on page 2-17

2.1.6 Leveraging Oracle Identity Management Infrastructure

Oracle Enterprise Manager 10g takes advantage of Oracle Identity Management in two ways:

- First, you can configure the Grid Control so it uses Oracle Application Server Single Sign-On. Administrators can then use their Single Sign-On credentials to log in to the Grid Control.

Similarly, you can configure the Oracle Enterprise Manager 10g Database Control so it uses Oracle Application Server Single Sign-On credentials.

See Also: *Oracle Application Server Single Sign-On Administrator's Guide* for general information about Oracle Application Server Single Sign-On

["Configuring Enterprise Manager for Use with Oracle Application Server Single Sign-On"](#) on page 2-20

- Second, you can take advantage of the Enterprise User Security features of the Oracle database. Enterprise User Security provides single sign-on (SSO) or single password authentication for your database users.

See Also: "Managing Enterprise User Security" in the *Oracle Advanced Security Administrator's Guide*

["Configuring Enterprise Manager for Use with Enterprise User Security"](#) on page 2-24

2.2 Configuring Security for the Grid Control Framework

This section contains the following topics:

- [About Enterprise Manager Framework Security](#)
- [Overview of the Steps Required to Enable Enterprise Manager Framework Security](#)
- [Enabling Security for the Oracle Management Service](#)
- [Enabling Security for the Oracle Management Agent](#)
- [Enabling Security with Multiple Management Service Installations](#)
- [Restricting HTTP Access to the Management Service](#)
- [Managing Agent Registration Passwords](#)
- [Enabling Security for the Management Repository Database](#)

2.2.1 About Enterprise Manager Framework Security

Enterprise Manager Framework Security provides safe and secure communication channels between the components of Enterprise Manager. For example, Framework Security provides secure connections between your Oracle Management Service and its Management Agents.

See Also: *Oracle Enterprise Manager Concepts* for an overview of Enterprise Manager components

Enterprise Manager Framework Security works in concert with—but does not replace—the security features you should enable for your Oracle HTTP Server. Oracle HTTP Server is part of the Oracle Application Server instance that is used to deploy the Management Service J2EE Web application.

See Also: *Oracle Application Server 10g Security Guide*

Figure 2-1 shows how Enterprise Manager Framework Security provides security for the connections between the Enterprise Manager components. However, the secure HTTPS connection between your browser and the Grid Control should be configured like any other Web application by using the security features of your Oracle HTTP Server.

Figure 2-1 *Enterprise Manager Framework Security*

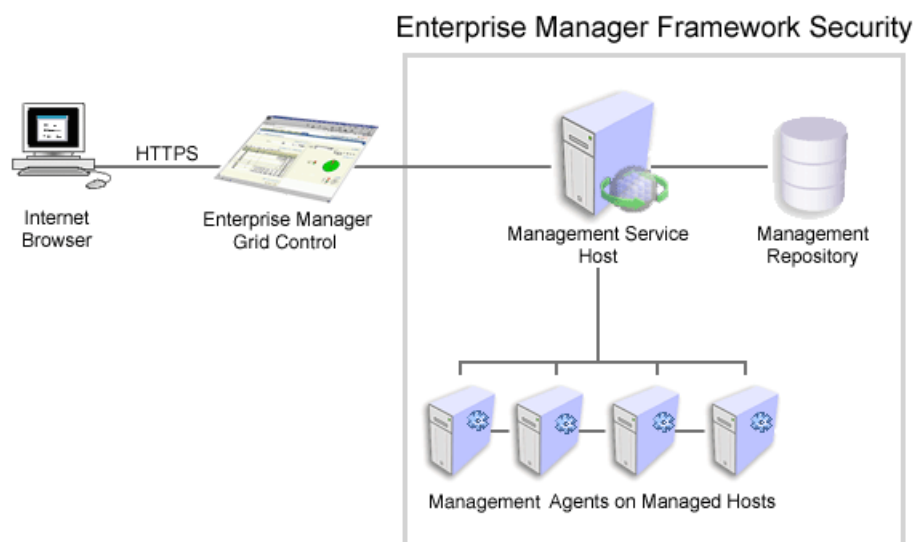

Enterprise Manager Framework Security implements the following types of secure connections between the Enterprise Manager components:

- HTTPS and Public Key Infrastructure (PKI) components, including signed digital certificates, for communications between the Management Service and the Management Agents.

See Also: *Oracle Security Overview* for an overview of Public Key Infrastructure features, such as digital certificates and public keys

- Oracle Advanced Security for communications between the Management Service and the Management Repository.

See Also: *Oracle Advanced Security Administrator's Guide*

2.2.2 Overview of the Steps Required to Enable Enterprise Manager Framework Security

To enable Enterprise Manager Framework Security, you must configure each of the Enterprise Manager components in a specific order. The following list outlines the process for securing the Management Service and the Management Agents that upload data to the Management Service:

1. Use the `opmnctl stopall` command to stop the Management Service, the Oracle HTTP Server, and the other components of the Oracle Application Server that are used to deploy the Management Service.
2. Use `emctl secure oms` to enable security for the Management Service.
3. Restart the Management Service, the Oracle HTTP Server, OracleAS Web Cache, and the other application server components using the `opmnctl startall` command.
4. For each Management Agent, stop the Management Agent, use the `emctl secure agent` command to enable security for the Agent, and restart the Management Agent.
5. After security is enabled for all the Management Agents, use the `emctl secure lock` command to restrict HTTP Access to the Management Service. This will ensure that all data gathered from the Management Agents is uploaded over a secure HTTPS connection.

The following sections describe how to perform each of these steps in more detail.

2.2.3 Enabling Security for the Oracle Management Service

To enable Enterprise Manager Framework Security for the Management Service, you use the `emctl secure oms` utility, which is located in the following subdirectory of the Management Service home directory:

```
$ORACLE_HOME/bin
```

The `emctl secure oms` utility performs the following actions:

- Generates a Root Key within your Management Repository. The Root Key is used during distribution of Oracle Wallets containing unique digital certificates for your Agents.
- Modifies your Oracle HTTP Server to enable an HTTPS channel between your Management Service and Management Agents, independent from any existing HTTPS configuration that may be present in your Oracle HTTP Server.
- Enables your Management Service to accept requests from Management Agents using Enterprise Manager Framework Security.

To run the `emctl secure oms` utility you must first choose an Agent Registration Password. The Agent Registration password is used to validate that future installation sessions of Oracle Management Agents are authorized to load their data into this Enterprise Manager installation.

To enable Enterprise Manager Framework Security for the Oracle Management Service:

1. Change directory to the following directory in the Management Service home:

```
ORACLE_HOME/opmn/bin
```

2. Stop the Management Service, the Oracle HTTP Server, and the other application server components using the following command:

```
$PROMPT> ./opmnctl stopall
```

3. Change directory to the following directory in the Management Service home:

```
ORACLE_HOME/bin
```

4. Enter the following command:

```
$PROMPT> ./emctl secure oms
```

Enterprise Manager prompts you for the Enterprise Manager Root Password.

5. Enter the password for the SYSMAN administrator account used for the Management Repository.

Enterprise Manager prompts you to specify an Agent Registration Password, which is a new password that will be required for any Management Agents that attempt to connect to the Management Service.

6. Specify an Agent Registration Password for the Management Service.

Enterprise Manager prompts you to confirm the hostname of the Management Service.

7. Enter the fully qualified name of the host (including the domain) where the Management Service resides.

The `emctl secure` utility reconfigures the Management Service to enable Framework Security. [Example 2-1](#) shows a sample of the output you should receive from the `emctl secure oms` command.

8. When the operation is complete, restart the Management Service, the Oracle HTTP Server, and OracleAS Web Cache:

```
$PROMPT> cd $ORACLE_HOME/opmn/bin
$PROMPT> ./opmnctl startall
```

9. After the Management Service restarts, test the secure connection to the Management Service by browsing to the following secure URL using the HTTPS protocol:

```
https://hostname.domain:4888/
```

For example:

```
https://mgmthost1.acme.com:4888/
```

If the Management Service security has been enabled, your browser displays the Oracle Application Server Welcome page.

The 4888 port number is the default secure port used by the Management Agents to upload data to the Management Service. This port number may vary if the default port is unavailable.

See Also: ["Viewing a Summary of the Ports Assigned During the Application Server Installation"](#) on page 3-9

Caution: While the `emctl secure oms` command provides immediate HTTPS browser access to the Grid Control via the secure Management Agent upload port, it does not enable security for the default OracleAS Web Cache or Oracle HTTP Server ports that your administrators use to display the Grid Control.

To enable security for users who access the Grid Control through OracleAS Web Cache and the default Oracle HTTP Server ports, refer to *Oracle Application Server 10g Security Guide*.

Example 2–1 Sample Output of the `emctl secure oms` Command

```
$PROMPT> ./emctl secure oms
Oracle Enterprise Manager 10g Release 10.1.0.2.0.
Copyright (c) 1996, 2003 Oracle Corporation. All rights reserved.
Enter Enterprise Manager Root Password :
Enter Agent Registration password :
Enter a Hostname for this OMS : hsunab14.us.oracle.com
Checking Repository... Done.
Checking Repository for an existing Enterprise Manager Root Key... Done.
Generating Enterprise Manager Root Key (this takes a minute)... Done.
Fetching Root Certificate from the Repository... Done.
Generating Registration Password Verifier in the Repository... Done.
Generating Oracle Wallet Password for Enterprise Manager OMS... Done.
Generating Oracle Wallet for Enterprise Manager OMS... Done.
Generating Oracle Wallet for iAS HTTP Server... Done.
Updating HTTPS port in emoms.properties file... Done.
Generating Oracle Wallet Distribution Service... Done.
Generating HTTPS Virtual Host for Enterprise Manager OMS... Done.
```

Note: Alternatively, you can enter the `emctl secure oms` command all on one line, but if you enter the command on one line, the passwords you enter will be displayed on the screen as you type:

```
$PROMPT> emctl secure oms sysman_pwd agent_reg_pwd
```

2.2.4 Enabling Security for the Oracle Management Agent

When you install the Management Agent on a host, you must identify the Management Service that will be used by the Management Agent. If the Management Service you specify has been configured to take advantage of Enterprise Manager Framework Security, you will be prompted for the Agent Registration Password and Enterprise Manager Framework Security will be enabled for the Agent during the installation.

Otherwise, if the Management Service has not been configured for Enterprise Manager Framework Security, then security will not be enabled for the Management Agent. In those cases, you can later enable Enterprise Manager Framework Security for the Management Agent.

To enable Enterprise Manager Framework Security for the Management Agent, you use the `emctl secure agent` utility, which is located in the following directory of the Management Agent home directory:

```
AGENT_HOME/bin (UNIX)
AGENT_HOME\bin (Windows)
```

The `emctl secure agent` utility performs the following actions:

- Obtains an Oracle Wallet from the Management Service that contains a unique digital certificate for the Management Agent. This certificate is required in order for the Management Agent to conduct SSL communication with the secure Management Service.
- Obtains an Agent Key for the Management Agent that is registered with the Management Service.
- Configures the Management Agent so it is available on your network over HTTPS and so it uses the Management Service HTTPS upload URL for all its communication with the Management Service.

To enable Enterprise Manager Framework Security for the Management Agent:

1. Ensure that your Management Service and the Management Repository are up and running.
2. Change directory to the following directory:

```
AGENT_HOME/bin (UNIX)
AGENT_HOME\bin (Windows)
```

3. Stop the Management Agent:

```
$PROMPT> ./emctl stop agent
```

4. Enter the following command:

```
$PROMPT> ./emctl secure agent (UNIX)
$PROMPT> emctl secure agent (Windows)
```

The `emctl secure agent` utility prompts you for the Agent Registration Password, authenticates the password against the Management Service, and reconfigures the Management Agent to use Enterprise Manager Framework Security.

Note: Alternatively, you can enter the command all on one line, but if you enter the command on one line, the password you enter will be displayed on the screen as you type:

```
$PROMPT> ./emctl secure agent agent_registration_pwd (UNIX)
$PROMPT> emctl secure agent agent_registration_pwd (Windows)
```

[Example 2-2](#) shows sample output of the `emctl secure agent` utility.

5. Restart the Management Agent:

```
$PROMPT> ./emctl start agent
```

6. Confirm that the Management Agent is secure by checking the Management Agent home page.

In the General section of the Management Agent home page ([Figure 2-2](#)), the **Secure Upload** field indicates whether or not Enterprise Manager Framework Security has been enabled for the Management Agent.

See Also: "Checking the Status of an Oracle Management Agent" in the Enterprise Manager online help

Example 2-2 Sample Output of the emctl secure agent Utility

```

$PROMPT> ./emctl secure agent
Oracle Enterprise Manager 10g Release 10.1.0.2.0.
Copyright (c) 1996, 2003 Oracle Corporation. All rights reserved.
Enter Agent Registration password :
Requesting an HTTPS Upload URL from the OMS... Done.
Requesting an Oracle Wallet and Agent Key from the OMS... Done.
Check if HTTPS Upload URL is accessible from the agent... Done.
Configuring Agent for HTTPS... Done.
EMD_URL set in /private/oracle/agent/sysman/config/emd.properties
$PROMPT>

```

Figure 2-2 Secure Upload Field on the Management Agent Home Page

General	
	Status Up
	Host usunnab05.us.oracle.com
	Management Service usunnab08.us.oracle.com:4888
	Secure Upload Yes
	Version 4.1.0.1.0
	Oracle Home /private/oracle/AGENT_SH5
	Data Pending Upload (MB) 0.000000
	Last Successful Upload Jan 14, 2003 12:53:38 PM

2.2.5 Enabling Security with Multiple Management Service Installations

If you already have a secure Management Service running and you install an additional Management Service that uses the same Management Repository, you will need to enable Enterprise Manager Framework Security for the new Management Service. This task is executed using the same procedure that you used to secure the first Management Service, by running the `emctl secure oms` utility.

Because you have already established at least one Agent Registration Password and a Root Key in your Management Repository, they must be used for your new Management Service. Your secure Management Agents can then operate against either Management Service.

All the registration passwords assigned to the current repository are listed on the Registration Passwords page in the Oracle Enterprise Manager 10g Grid Control.

See Also: ["Managing Agent Registration Passwords"](#) on page 2-12

If you install a new Management Service that uses a new Management Repository, the new New Management Service is considered to be a distinct enterprise. There is no way for the new Management Service to partake in the same security trust relationship as another Management Service that uses a different Management Repository. Secure Management Agents of one Management Service will not be able to operate against the other Management Service.

2.2.6 Restricting HTTP Access to the Management Service

By default, when you enable Enterprise Manager Framework Security on your Oracle Management Service there are no default restrictions on HTTP access. Any Oracle Management Agent can access the Grid Control and Management Service using HTTP or HTTPS connections.

However, it is important that only secure Management Agent installations that use the Management Service HTTPS channel are able to upload data to your Management Repository.

To restrict access so Management Agents can upload data to the Management Service only over HTTPS:

1. Stop the Management Service, the Oracle HTTP Server, and the other application server components:

```
$PROMPT> cd $ORACLE_HOME/opmn/bin
$PROMPT> ./opmnctl stopall
```

2. Change directory to the following location in the Management Service home:

```
$ORACLE_HOME/bin
```

3. Enter the following command to prevent Management Agents from uploading data to the Management Service over HTTP:

```
$PROMPT> emctl secure lock
```

4. Restart the Management Service, the Oracle HTTP Server, and the other application server components:

```
$PROMPT> cd $ORACLE_HOME/opmn/bin
$PROMPT> ./opmnctl startall
```

5. Verify that you cannot access the Management Agent upload URL using the HTTP protocol:

For example, navigate to the following URL:

```
http://hostname.domain:4889/em/upload
```

You should receive an error message similar to the following:

```
Forbidden
You don't have permission to access /em/upload on this server
```

6. Verify that you can access the Management Agent using the HTTPS protocol:

For example, navigate to the following URL:

```
https://hostname.domain:4888/em/upload
```

You should receive the following message, which confirms the secure upload port is available to secure Management Agents:

```
Http XML File receiver
Http Receiver Servlet active!
```

To remove the restriction for HTTPS uploads from the Management Agents, repeat the preceding procedure, but replace the `emctl secure lock` command with the following command:

```
$PROMPT> emctl secure unlock
```

Caution: The `emctl secure lock` command does not prevent users from accessing the Oracle Enterprise Manager 10g Grid Control over HTTP. It restricts non-secure access only for Management Agents that attempt to upload data to the Management Service using the upload URL, which is usually:

`http://hostname.domain:4889/em/upload`

To restrict HTTP access to the Oracle Enterprise Manager 10g Grid Control, configure your Oracle HTTP Server and OracleAS Web Cache as described in the Oracle Application Server documentation.

See Also: *Oracle HTTP Server Administrator's Guide*

2.2.7 Managing Agent Registration Passwords

Enterprise Manager uses the Agent Registration password to validate that installations of Oracle Management Agents are authorized to load their data into the proper Oracle Management Service.

You create the registration password when you use `emctl secure oms` to configure security for the Oracle Management Service installation.

2.2.7.1 Using the Grid Control to Manage Agent Registration Passwords

After you enable security for your Enterprise Manager components, you can use the Grid Control to manage your existing registration passwords or create additional registration passwords:

1. Click **Setup** at the top of any Grid Control page.
2. Click **Registration Passwords**.

Enterprise Manager displays the Registration Passwords page (Figure 2-3). After you enable security for the Management Service, the registration password you created when you ran the `emctl secure oms` command appears in the Registration Passwords table.

3. Use the Registration Passwords page to change your registration password, create additional registration passwords, or remove registration passwords associated with the current Management Repository.

Figure 2-3 Managing Registration Passwords in the Grid Control

ORACLE
Enterprise Manager

Setup Preferences Help
Home Targets Deployments Alerts Jobs Management Sys

Setup

Roles
Administrators
Notification Methods
Patching Setup
Blackouts
Registration Passwords

Registration Passwords

Registration Passwords are used by Administrators to secure Oracle Agents against any OMS that u this Repository. When defining Registration Passwords you may specify an expire date after which th password will be invalid or you may specify that the password can only be used one time after which i deleted automatically from the Repository.

Add Registration Password Edit Remove

Select	Description	Type	Expire Date
<input checked="" type="checkbox"/>	OMS: <dsunrap27.us.oracle.com:4889>:Initial IPW	persistent	No Expire Date

Home | Targets | Deployments | Alerts | Jobs | Management System | Setup | Preferences | Help | Logout
Copyright © 1996, 2003, Oracle. All rights reserved.
About Oracle Enterprise Manager

When you create or edit an Agent Registration Password on the Registration Passwords page, you can determine whether the password is persistent and available for multiple agents or to be used only once or for a predefined period of time.

For example, if an administrator requests to install a Management Agent on a particular host, you can create a one-time-only password that the administrator can use to install and configure one Management Agent.

On the other hand, you can create a persistent password that an administrator can use for the next two weeks before it expires and the administrator must ask for a new password.

2.2.7.2 Using emctl to Change the Agent Registration Password

To change an existing Agent Registration Password, use the following `emctl` command:

```
$PROMPT> emctl secure setpwd sysman_password new_Install_Password
```

Note that the `emctl secure setpwd` command requires that you provide the password of the Enterprise Manager super administrator user, `sysman`, to authorize the resetting of the Agent Registration Password.

If you change the Agent Registration Password, you must communicate the new password to other Enterprise Manager administrators who need to install new Management Agents, enable Enterprise Manager Framework Security for existing Management Agents, or install additional Management Services.

As with other security passwords, you should change the Agent Registration Password on a regular and frequent basis to prevent it from becoming too widespread.

2.2.8 Enabling Security for the Management Repository Database

This section describes how to enable Security for the Oracle Management Repository. This section includes the following topics:

- [About Oracle Advanced Security and the `sqlnet.ora` Configuration File](#)

- [Configuring the Management Service to Connect to a Secure Management Repository Database](#)
- [Enabling Oracle Advanced Security for the Management Repository](#)
- [Enabling Security for the Management Agent that is Monitoring a Secure Management Repository or Database](#)

2.2.8.1 About Oracle Advanced Security and the `sqlnet.ora` Configuration File

You enable security for the Management Repository by using Oracle Advanced Security. Oracle Advanced Security ensures the security of data transferred to and from an Oracle database.

See Also: *Oracle Advanced Security Administrator's Guide*

To enable Oracle Advanced Security for the Management Repository database, you must make modifications to the `sqlnet.ora` configuration file. The `sqlnet.ora` configuration file is used to define various database connection properties, including Oracle Advanced Security parameters.

The `sqlnet.ora` file is located in the following subdirectory of the Database home:

```
ORACLE_HOME/network/admin
```

After you have enabled Security for the Management Repository and the Management Services that communicate with the Management Repository, you must also configure Oracle Advanced Security for the Management Agent by modifying the `sqlnet.ora` configuration file in the Management Agent home directory.

See Also: "[Enabling Security for the Management Agent that is Monitoring a Secure Management Repository or Database](#)" on page 2-17

It is important that both the Management Service and the Management Repository are configured to use Oracle Advanced Security. Otherwise, errors will occur when the Management Service attempts to connect to the Repository. For example, the Management Service might receive the following error:

```
ORA-12645: Parameter does not exist
```

To correct this problem, be sure both the Management Service and the Management Repository are configured as described in the following sections.

Note: The procedures in this section describe how to manually modify the `sqlnet.ora` configuration file to enable Oracle Advanced Security. Alternatively, you can make these modifications using the administration tools described in the *Oracle Advanced Security Administrator's Guide*.

2.2.8.2 Configuring the Management Service to Connect to a Secure Management Repository Database

If you have enabled Oracle Advanced Security for the Management Service database—or if you plan to enable Oracle Advanced Security for the Management Repository database—use the following procedure to enable Oracle Advanced Security for the Management Service:

1. Stop the Management Service:

```
$PROMPT> ORACLE_HOME/bin/emctl stop oms
```

2. Locate the following configuration file in the Management Service home directory:

```
ORACLE_HOME/network/admin/emoms.properties
```

3. Using a text editor, add the entries described in [Table 2–1](#) to the `emoms.properties` file.

The entries described in the table correspond to valid parameters you can set when you configure network data encryption for the Oracle Database.

See Also: "Configuring Network Data Encryption and Integrity for Oracle Servers and Clients" in the *Oracle Application Server 10g Administrator's Guide*

4. Save your changes and exit the text editor.
5. Restart the Management Service.

See Also: "[Controlling the Oracle Management Service](#)" on page 1-16

Table 2–1 Oracle Advanced Security Properties in the Enterprise Manager Properties File

Property	Description
<code>oracle.sysman.emRep.dbConn.enableEncryption</code>	<p>Defines whether or not Enterprise Manager will use encryption between Management Service and Management Repository.</p> <p>Possible values are TRUE and FALSE. The default value is FALSE.</p> <p>For example:</p> <pre>oracle.sysman.emRep.dbConn. enableEncryption=true</pre>
<code>oracle.net.encryption_client</code>	<p>Defines the Management Service encryption requirement.</p> <p>Possible values are REJECTED, ACCEPTED, REQUESTED, REQUIRED.</p> <p>The default value is REQUESTED. In other words, if the database supports secure connections, then the Management Service uses secure connections, otherwise the Management Service uses insecure connections.</p> <p>For example:</p> <pre>oracle.net. encryption_client=REQUESTED</pre>

Table 2–1 (Cont.) Oracle Advanced Security Properties in the Enterprise Manager Properties File

Property	Description
oracle.net.encryption_types_client	<p>Defines the different types of encryption algorithms the client supports.</p> <p>Possible values should be listed within parenthesis. The default value is (DES40C).</p> <p>For example:</p> <pre>oracle.net. encryption_types_client= (DES40C)</pre>
oracle.net.crypto_checksum_client	<p>Defines the Client's checksum requirements.</p> <p>Possible values are REJECTED, ACCEPTED, REQUESTED, REQUIRED.</p> <p>The default value is REQUESTED. In other words, if the server supports checksum enabled connections, then the Management Service uses them, otherwise it uses normal connections.</p> <p>For example:</p> <pre>oracle.net. crypto_checksum_client=REQUESTED</pre>
oracle.net.crypto_checksum_types_client	<p>This property defines the different types of checksums algorithms the client supports.</p> <p>Possible values should be listed within parentheses. The default value is (MD5).</p> <p>For example:</p> <pre>oracle.net. crypto_checksum_types_client= (MD5)</pre>

2.2.8.3 Enabling Oracle Advanced Security for the Management Repository

To be sure your database is secure and that only encrypted data is transferred between your database server and other sources, review the security documentation available in the Oracle Database 10g documentation library.

See Also: *Oracle Advanced Security Administrator's Guide*

The following instructions provide an example of how you can confirm that Oracle Advanced Security is enabled for your Management Repository database and its connections with the Management Service:

1. Locate the `sqlnet.ora` configuration file in the following directory of the database Oracle Home:

```
ORACLE_HOME/network/admin
```

2. Using a text editor, look for the following entries (or similar entries) in the `sqlnet.ora` file:

```
SQLNET.ENCRYPTION_SERVER = REQUESTED
SQLNET.CRYPTO_SEED = "abcdefg123456789"
```

See Also: "Configuring Network Data Encryption and Integrity for Oracle Servers and Clients" in the *Oracle Application Server 10g Administrator's Guide*

3. Save your changes and exit the text editor.

2.2.8.4 Enabling Security for the Management Agent that is Monitoring a Secure Management Repository or Database

After you have enabled Oracle Advanced Security for the Management Repository, you must also enable Advanced Security for the Management Agent that is monitoring the repository:

1. Locate the `sqlnet.ora` configuration file in the following directory inside the home directory for the Management Agent that is monitoring the Management Repository:

`AGENT_HOME/network/admin` (UNIX)

`AGENT_HOME\network\admin` (Windows)

2. Using a text editor, add the following entry to the `sqlnet.ora` configuration file:

```
SQLNET.CRYPTO_SEED = "abcdefg123456789"
```

See Also: "Configuring Network Data Encryption and Integrity for Oracle Servers and Clients" in the *Oracle Application Server 10g Administrator's Guide*

3. Save your changes and exit the text editor.
4. Restart the Management Agent.

See Also: ["Controlling the Oracle Management Agent"](#) on page 1-14

2.3 Configuring Security for the Enterprise Manager Application Server Control

When you install Oracle Application Server 10g Release 2 (9.0.4), the installation procedure also installs and configures the Oracle Enterprise Manager 10g Application Server Control, which you use to manage your application server instances.

See Also: "Introduction to Administration Tools" in the *Oracle Application Server 10g Administrator's Guide* for more information about using the Application Server Control

The Application Server Control relies on several underlying technologies, including a version of the Oracle Management Agent that is designed to provide monitoring data to the Application Server Control.

By default, you access the Application Server Control through your Web browser using the non-secure, HTTP protocol. In addition, communications between the local Oracle Management Agent and the Application Server Control are transferred over an insecure HTTP connection.

To secure the communications between the Management Agent and the Application Server Control, and to provide HTTPS access to the Application Server Control, Enterprise Manager provides the `emctl secure em` command-line utility.

The `emctl secure em` utility enables HTTPS and Public Key Infrastructure (PKI) components, including signed digital certificates, for communications between the Application Server Control and the local Management Agent.

Caution: Before you use the `emctl secure agent` command to secure the Application Server Control, be sure to stop the Application Server Control.

To configure security for the Application Server Control, use the following procedure:

1. Stop the Application Server Control by entering the following command in the `IAS_HOME/bin` directory:

```
$PROMPT> ./emctl stop iasconsole
```

2. Enter the following command in the `ORACLE_HOME/bin` directory:

```
$PROMPT> ./emctl secure em
```

Enterprise Manager secures the Application Server Control. Sample output of the `emctl secure em` command is shown in [Example 2-3](#).

3. Start the Application Server Control by entering the following command in the `IAS_HOME/bin` directory:

```
$PROMPT> ./emctl start iasconsole
```

4. Test the security of the Application Server Control by entering the following URL in your Web browser:

```
https://hostname:port/
```

For example:

```
https://mgmthost1:1812/
```

Example 2-3 Sample Output from the `emctl secure em` Command

```
$PROMPT> ./emctl secure em
Oracle Enterprise Manager 9.0.4
Copyright (c) 2002, 2003 Oracle Corporation. All rights reserved.
Generating Standalone Console Root Key (this takes a minute)... Done.
Fetching Standalone Console Root Certificate... Done.
Generating Standalone Console Agent Key... Done.
Generating Oracle Wallet for the Standalone Console Agent... Done.
Configuring Agent for HTTPS... Done.
EMD_URL set in /dsk01/oracle/appserver1/sysman/config/emd.properties
Generating Standalone Console Java Keystore... Done.
$PROMPT>
```

2.4 Configuring Security for the Oracle Enterprise Manager 10g Database Control

This section describes the architecture and configuration of security for the Oracle Enterprise Manager 10g Database Control.

See Also: *Oracle Database Security Guide* for an overview of Oracle Database 10g security features

Oracle strongly recommends that you use the Secure Socket Layer (SSL) protocol and HTTPS for all connections to Enterprise Manager and that you use a valid digital security certificate.

To configure security for the Database Control:

1. Stop the Database Control by entering the following command in the ORACLE_HOME/bin directory (UNIX) or the ORACLE_HOME\bin (Windows):

```
$PROMPT> ./emctl stop dbconsole (UNIX)
$PROMPT> emctl stop dbconsole (Windows)
```

See Also: ["Controlling the Database Control on UNIX"](#) on page 1-18

2. Change directory to the ORACLE_HOME/bin directory or the ORACLE_HOME\bin (Windows) and enter the following emctl command

```
$PROMPT> ./emctl secure dbconsole (UNIX)
$PROMPT> emctl secure dbconsole (Windows)
```

Enterprise Manager prompts you for the Enterprise Manager Root Password.

3. Enter the password for the SYSMAN database user.

Enterprise Manager prompts you to specify an Agent Registration Password, which is a new password that will be required for any Management Agents that attempt to connect to the Management Service.

4. Specify an Agent Registration Password for the Management Service.

Enterprise Manager prompts you to confirm the hostname of the Management Service.

5. Enter the name of the host where the Management Service resides.

The emctl secure utility reconfigures the Management Service to enable Framework Security. If the Management Service is up and running, Enterprise Manager restarts the Management Service.

When the operation is complete, communications between the Enterprise Manager components is secure.

In addition, you can access the Grid Control using the HTTPS protocol.

6. Start the Database Control by entering the following command in the ORACLE_HOME/bin directory or the ORACLE_HOME\bin (Windows):

```
$PROMPT> ./emctl start dbconsole (UNIX)
$PROMPT> emctl start dbconsole (Windows)
```

See Also: ["Controlling the Database Control on UNIX"](#) on page 1-18

7. Test the security of the Database Control by entering the following URL in your Web browser:

```
https://hostname:port/em
```

For example:

```
https://dbhost1:1820/em
```

Note: Alternatively, you can enter the `emctl secure dbconsole` command all on one line, but if you enter the command on one line, the passwords you enter will be displayed on the screen as you type:

```
$PROMPT> emctl secure dbconsole sysman_pwd agent_reg_pwd
```

2.5 Configuring Enterprise Manager for Use with Oracle Application Server Single Sign-On

If you are currently using Oracle Application Server Single Sign-On to control access and authorization for your enterprise, you can extend those capabilities to the Grid Control.

By default, when you navigate to the Grid Control, Enterprise Manager displays the Enterprise Manager login page. However, you can configure Enterprise Manager so it uses Oracle Application Server Single Sign-On to authorize your Grid Control users. Instead of seeing the Enterprise Manager login page, Grid Control users will see the standard Oracle Application Server Single Sign-On login page. From the login page, administrators can use their Oracle Application Server Single Sign-On credentials to access the Oracle Enterprise Manager 10g Grid Control.

The following sections describe how to configure Enterprise Manager as a OracleAS Single Sign-On Partner Application:

- [Configuring Enterprise Manager to Use the Single Sign-On Logon Page](#)
- [Registering Single Sign-On Users as Enterprise Manager Administrators](#)
- [Grid Control as a Single Sign-On Partner Application](#)
- [Bypassing the Single Sign-On Logon Page](#)

2.5.1 Configuring Enterprise Manager to Use the Single Sign-On Logon Page

To configure the Grid Control for use with Oracle Application Server Single Sign-On:

1. Set the `ORACLE_HOME` environment variables to the Management Service home directory.

For example:

```
$PROMPT> setenv ORACLE_HOME /dev01/oracle/em10g_GridControl
```

2. Change directory to the bin directory of the Management Service Oracle home:

```
$PROMPT> cd $ORACLE_HOME/opmn/bin
```

3. Stop the Management Service, the Oracle HTTP Server, and the other components of the application server:

```
$PROMPT> ./opmnctl stopall
```

4. Change directory to the bin directory of the Management Service Oracle home:

```
$PROMPT> cd $ORACLE_HOME/bin
```

5. Enter the following command at the operating system prompt:

```
$PROMPT> ./emctl config oms sso -host ssoHost -port ssoPort -sid ssoSid -pass ssoPassword -das http://ssohost:port/
```

For example:

```
$PROMPT> ./emctl config oms sso -host sshost1.acme.com -port 1521 -sid asdb
-pass Ch22x5xt -das http://ssohost1.acme.com:7777
```

Table [Table 2–2](#) describes the arguments on the `emctl config oms sso` command line.

[Example 2–4](#) shows the typical output generated by the `emctl config oms sso` command.

- Restart the Management Service, Oracle HTTP Server, and the other application server components:

```
$PROMPT> cd $ORACLE_HOME/opmn/bin
$PROMPT> ./opmnctl startall
```

- Go the Grid Control URL.

For example:

```
http://mgmthost1.acme.com:7777/em
```

The browser is redirected to the standard Single Sign-On Logon page.

Table 2–2 Arguments for the `emctl sso` Command

Argument	Description
-host	The name of the host computer where the Oracle Application Server Single Sign-On server resides. Be sure to use the fully-qualified host name.
-port	The port for the Oracle Application Server Single Sign-On database. For example, 1521.
-sid	The system identifier (SID) for the Oracle Application Server Single Sign-On database.
-pass	The password for the Oracle Application Server Single Sign-On schema (<code>orasso</code>). The <code>orasso</code> schema password is randomized when the Oracle Application Server infrastructure is installed. To obtain the password, see "Obtaining the Single Sign-On Schema Password" in the <i>Oracle Application Server Single Sign-On Administrator's Guide</i> .
-das	The URL containing the host and port for the Delegated Administration Service (DAS). Generally, the DAS hostname and port are the same as the hostname and port of the Oracle Application Server Single Sign-On server. For example: <code>http://mgmthost1.acme.com:7777</code>

Example 2–4 Sample Output of the `emctl config oms sso` Command

```
$PROMPT> ../opmn/bin/opmnctl stopall
opmnctl: stopping opmn and all managed processes...
$PROMPT> ./emctl config oms sso -host mgmthost1.acme.com -port 1521 -sid asdb
-pass E9p36Yst -das http://mgmthost1.acme.com:7777
Oracle Enterprise Manager 10g Release 10.1.0.2.0.
Copyright (c) 1996, 2003 Oracle Corporation. All rights reserved.
/private/oracle/em10gRel5a/Apache/Apache/conf/httpd.conf has already been
set to enable SSO.
/private/oracle/em10gRel5a/sysman/config/emoms.properties has been modified.
Registering to SSO server, please wait...
```

```

Parameters passed to SSO registration tool :
param0:-oracle_home_path param1:/private/oracle/em10gRel5a param2:-host
param3:mgmthost1.acme.com param4:-port param5:1521 param6:-sid param7:asdb
param8:-schema param9:orasso param10:-pass param11:E9p36Yst param12:-site_name
param13:ssohost2.acme.com:7777 param14:-success_url
param15:http://ssohost2.acme.com:7777/osso_login_success param16:-logout_url
param17:http://ssohost2.acme.com:7777/osso_logout_success param18:-cancel_url
param19:http://ssohost2.acme.com:7777/ param20:-home_url
param21:http://ssohost2.acme.com:7777/ param22:-config_mod_osso param23:TRUE
param24:-u param25:oracle param26:-sso_server_version param27:v1.2
-DinstallType=
-DoldOracleHome=
-DoldOHSUser=root
Check /private/oracle/em10gRel5a/sso/log/ssoreg.log for the result of registration
$PROMPT> ../opmn/bin/opmnctl startall
opmnctl: starting opmn and all managed processes...
$PROMPT>

```

2.5.2 Registering Single Sign-On Users as Enterprise Manager Administrators

After you have configured Enterprise Manager to use the Single Sign-On logon page, you can register any Single Sign-On user as an Enterprise Manager administrator:

1. Go the Grid Control URL.

For example:

```
http://mgmthost1.acme.com:7777/em
```

The browser is redirected to the standard Single Sign-On Logon page.

2. Enter the credentials for a valid Single Sign-On user.

If the Single Sign-On user is not an Enterprise Manager administrator, the browser is redirected to a modified version of the Enterprise Manager logon page (Figure 2-4).

3. Log in to Enterprise Manager as a Super Administrator.
4. Click **Setup** and then click **Administrators** to display the Administrators page.

See Also: "Creating, Editing, and Viewing Administrators" in the Enterprise Manager online help

Because Enterprise Manager has been configured to use Single Sign-On, the first page in the Create Administrator wizard now offers you the option of creating an administrator based on a registered Oracle Internet Directory user (Figure 2-5).

5. Select **Oracle Internet Directory** and advance to the next page in the wizard.
6. Enter the name and email address of the Oracle Internet Directory user, or click the flashlight icon to search for a user name in the Oracle Internet Directory.
7. Use the rest of the wizard pages to define the roles, system privileges, and other characteristics of the Enterprise Manager administrator and then click **Finish**.

Enterprise Manager displays a summary page that lists the characteristics of the administrator account.

8. Click **Finish** to create the new Enterprise Manager administrator.

The OID user is now included in the list of Enterprise Manager administrators. You can now verify the account by logging out of the Grid Control and logging back in using the OID user credentials on the Single Sign-On logon page.

Figure 2–4 Modified Enterprise Manager Logon Page When Configuring SSO

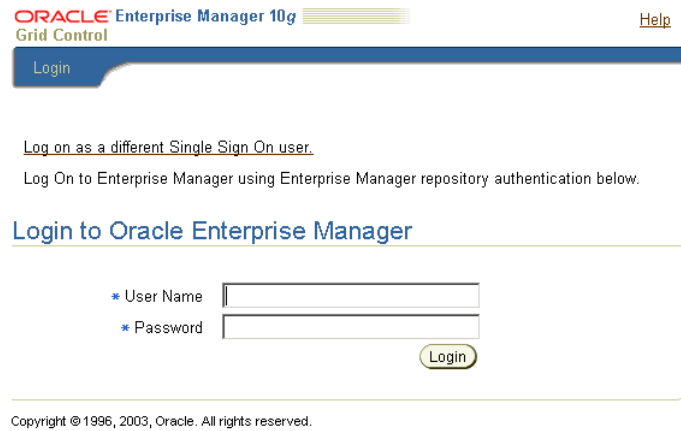
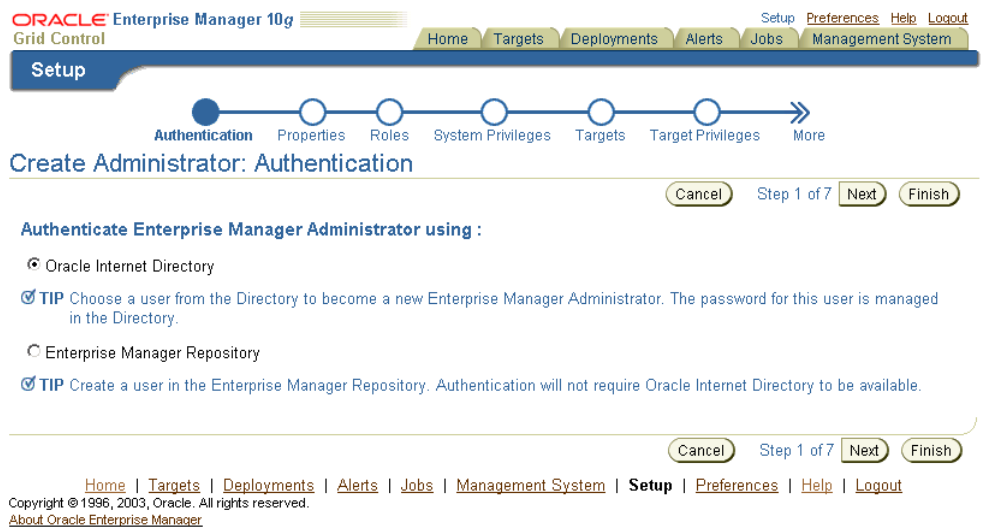

Figure 2–5 Create Administrator Page When SSO Support Is Enabled



2.5.3 Grid Control as a Single Sign-On Partner Application

The `emctl config oms sso` command adds the Oracle Enterprise Manager 10g Grid Control as an Oracle Application Server Single Sign-On partner application. Partner applications are those applications that have delegated authentication to the Oracle Application Server Single Sign-On Server.

To see the list of partner applications, navigate to the following URL:

`http://hostname:port/pls/orasso/orasso.home`

For example:

`http://ssohost1.acme.com:7777/pls/orasso/orasso.home`

2.5.4 Bypassing the Single Sign-On Logon Page

After you configure Enterprise Manager to use the Single Sign-On logon page, you can bypass the Single Sign-On page at any time and go directly to the Enterprise Manager logon page by entering the following URL:

```
http://hostname.domain:port/em/console/logon/logon
```

For example:

```
http://mgmthost1.acme.com:7777/em/console/logon/logon
```

2.6 Configuring Enterprise Manager for Use with Enterprise User Security

Enterprise User Security enables you to create and store Oracle9i database information as directory objects in an LDAP-compliant directory server. For example, an administrator can create and store enterprise users and roles for the Oracle9i database in the directory, which helps centralize the administration of users and roles across multiple databases.

See Also: "Enterprise User Security Configuration Tasks and Troubleshooting" in the *Oracle Advanced Security Administrator's Guide*

If you currently use Enterprise User Security for all your Oracle9i databases, you can extend this feature to Enterprise Manager. Configuring Enterprise Manager for use with Enterprise User Security simplifies the process of logging in to database targets you are managing with the Oracle Enterprise Manager 10g Grid Control.

To configure Enterprise Manager for use with Enterprise User Security:

1. Ensure that you have enabled Enterprise User Security for your Oracle Management Repository database, as well as the database targets you will be managing with the Grid Control.
2. Stop the Oracle Management Service.

See Also: "[Controlling the Oracle Management Service](#)" on page 1-16

3. Change directory to the IAS_HOME/sysman/config directory and open the `emoms.properties` file with your favorite text editor.
4. Add the following entry in the `emoms.properties` file:

```
oracle.sysman.emSDK.sec.DirectoryAuthenticationType=EnterpriseUser
```

5. Save and close the `emoms.properties` file.
6. Start the Management Service.

The next time you use the Oracle Enterprise Manager 10g Grid Control to drill down to a managed database, Enterprise Manager will attempt to connect to the database using Enterprise User Security. If successful, Enterprise Manager will connect you to the database without displaying a login page. If the attempt to use Enterprise User Security fails, Enterprise Manager will prompt you for the database credentials.

2.7 Additional Security Considerations

After you enable security for the Enterprise Manager components and framework, there are additional security considerations. This section provides the following topics:

- [Responding to Browser-Specific Security Certificate Alerts](#)
- [Configuring Beacons to Monitor Web Applications Over HTTPS](#)

2.7.1 Responding to Browser-Specific Security Certificate Alerts

This section describes how to respond to browser-specific security alert dialog boxes when you are using Enterprise Manager in a secure environment.

The security alert dialog boxes described in this section should appear only if you have enabled Enterprise Manager Framework Security, but you have not completed the more extensive procedures to secure your Oracle HTTP Server properly.

See Also: *Oracle Application Server 10g Security Guide*

This section contains the following topics:

- [Responding to the Internet Explorer Security Alert Dialog Box](#)
- [Responding to the Netscape Navigator New Site Certificate Dialog Box](#)
- [Preventing the Display of the Internet Explorer Security Information Dialog Box](#)

2.7.1.1 Responding to the Internet Explorer Security Alert Dialog Box

If you enable security for the Management Service, but you do not enable the more extensive security features of your Oracle HTTP Server, you will likely receive a Security Alert dialog box similar to the one shown in [Figure 2-6](#) when you first attempt to display the Grid Control using the HTTPS URL in Internet Explorer.

Note: The instructions in this section apply to Internet Explorer 5.5. The instructions may vary for other supported browsers.

Figure 2-6 *Internet Explorer Security Alert Dialog Box*

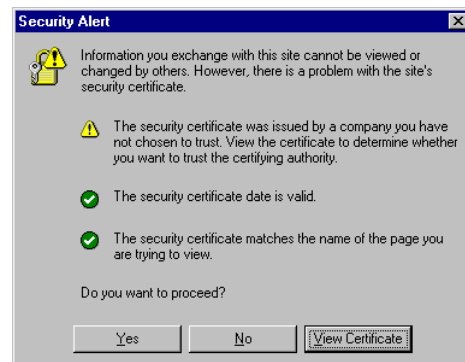

When Internet Explorer displays the Security Alert dialog box, use the following instructions to install the certificate and avoid viewing this dialog box again in future Enterprise Manager sessions:

1. In the Security Alert dialog box, click **View Certificate**.

Internet Explorer displays the Certificate dialog box.

2. Click the **Certificate Path** tab and select the first entry in the list of certificates as shown in [Figure 2–7](#).
3. Click **View Certificate** to display a second Certificate dialog box.
4. Click **Install Certificate** to display the Certificate Import wizard.
5. Accept the default settings in the wizard, click **Finish** when you are done, and then click **Yes** in the Root Certificate Store dialog box.

Internet Explorer displays a message box indicating that the Certificate was imported successfully.

6. Click **OK** to close each of the security dialog boxes and click **Yes** on the Security Alert dialog box to continue with your browser session.

You should no longer receive the Security Alert dialog box in any future connections to Enterprise Manager when you use this browser.

Figure 2–7 Certificate Path Tab on the Internet Explorer Certificate Dialog Box

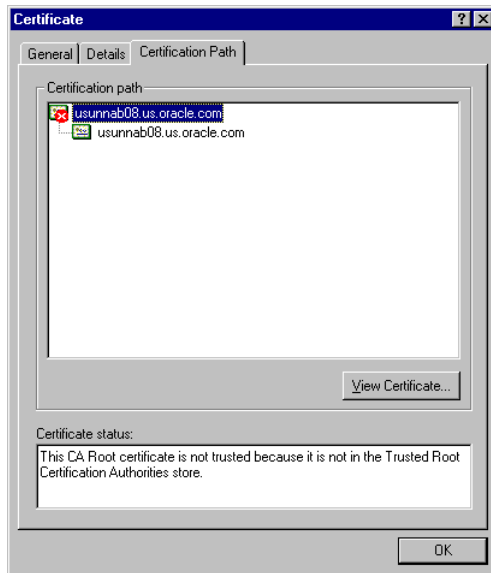

2.7.1.2 Responding to the Netscape Navigator New Site Certificate Dialog Box

If you enable security for the Management Service, but you do not enable the more extensive security features of your Oracle HTTP Server, you will likely receive a New Site Certificate dialog box similar to the one shown in [Figure 2–8](#) when you first attempt to display the Grid Control using the HTTPS URL in Netscape Navigator.

Note: The instructions in this section apply to Netscape Navigator 4.79. The instructions may vary for other supported browsers.

When Netscape Navigator displays the New Site Certificate dialog box, use the following instructions to install the certificate and avoid viewing this dialog box again in future Enterprise Manager sessions:

1. Review the instructions and information on each wizard pages; click **Next** until you are prompted to accept the certificate.
2. Select **Accept this certificate forever (until it expires)** from the list of options.

3. On the last screen of the wizard, click **Finish** to close the wizard and continue with your browser session.

You should no longer receive the Security Alert dialog box when using the current browser.

Figure 2–8 Netscape Navigator New Site Certificate Dialog Box



2.7.1.3 Preventing the Display of the Internet Explorer Security Information Dialog Box

After you enable Security for the Management Service, you may receive a dialog box similar to the one shown in [Figure 2–9](#) whenever you access certain Enterprise Manager pages.

Note: The instructions in this section apply to Internet Explorer 6.0. The instructions may vary for other supported browsers.

Figure 2–9 Internet Explorer Security Information Dialog Box

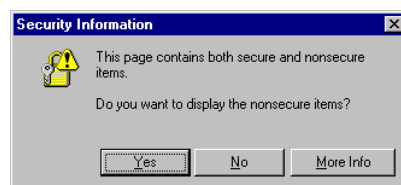

To stop this dialog box from displaying:

1. Select **Internet Options** from the Internet Explorer **Tools** menu.
2. Click the **Security** tab.
3. Select **Internet** and then click **Custom Level**.

Internet Explorer displays the Security Settings dialog box.

4. Scroll down to **Miscellaneous** settings and enable the **Display Mixed Content** option.

2.7.2 Configuring Beacons to Monitor Web Applications Over HTTPS

Oracle Beacons provide application performance availability and performance monitoring. They are part of the Application Performance Management features of Enterprise Manager.

See Also: "About Application Performance Management" in the Enterprise Manager Online Help

When a Beacon is used to monitor a URL over SSL (using an HTTPS URL), the Beacon must be configured to recognize the Certificate Authority that has been used by the Web site where that URL resides.

See Also: "The Public Key Infrastructure Approach to Security" in *Oracle Security Overview* for an overview of Public Key Infrastructure features, such as Certificate Authorities

The Beacon software is preconfigured to recognize most commercial Certificate Authorities that are likely to be used by a secure Internet Web Site. However, you may encounter Web Sites that, although available over HTTPS, do not have a Certificate that has been signed by a commercial Certificate Authority recognized by the Beacon.

In those cases, for example, if you attempt to use the Test section of the Beacon Performance page to test the HTTP Response of the secure URL, the following error appears in the **Status Description** column of the Response Metrics table on the URL Test Page:

```
javax.net.ssl.SSLException: SSL handshake failed:  
X509CertChainIncompleteErr--https://mgmtsys.acme.com/OracleMyPage.Home
```

See Also: "Using Beacons to Monitor Remote URL Availability" in the Enterprise Manager online help

To correct this problem you must allow the Beacon to recognize the Certificate Authority that was used by the Web Site to support HTTPS. You must add the Certificate of that Certificate Authority to the list of Certificate Authorities recognized by Beacon.

To configure the Beacon to recognize the Certificate Authority:

1. Obtain the Certificate of the Web Site's Certificate Authority, as follows:
 - a. In Microsoft Internet Explorer, connect to the HTTPS URL of the Web Site you are attempting to monitor.
 - b. Double-click the lock icon at the bottom of the browser screen, which indicates that you have connected to a secure Web site.

The browser displays the Certificate dialog box, which describes the Certificate used for this Web site. Other browsers offer a similar mechanism to view the Certificate detail of a Web Site.

- c. Click the **Certificate Path** tab and select the first entry in the list of certificates as shown in [Figure 2-7](#).
- d. Click **View Certificate** to display a second Certificate dialog box.
- e. Click the **Details** tab on the Certificate window.
- f. Click **Copy to File** to display the Certificate Manager Export wizard.

Configuring Enterprise Manager for Firewalls

Firewalls protect a company's Information Technology (IT) infrastructure by providing the ability to restrict network traffic by examining each network packet and determining the appropriate course of action.

Firewall configuration typically involves restricting the ports that are available to one side of the firewall, for example the Internet. It can also be set up to restrict the type of traffic that can pass through a particular port such as HTTP. If a client attempts to connect to a restricted port (a port not covered by a security "rule") or uses a protocol that is incorrect, then the client will be disconnected immediately by the firewall. Firewalls can also be used within a company Intranet to restrict user access to specific servers.

You can deploy the components of Oracle Enterprise Manager on different hosts throughout your enterprise. These hosts can be separated by firewalls. This chapter describes how firewalls can be configured to allow communication between the Enterprise Manager components.

This chapter contains the following topics:

- [Considerations Before Configuring Your Firewall](#)
- [Firewall Configurations for Enterprise Management Components](#)
- [Viewing a Summary of the Ports Assigned During the Application Server Installation](#)

3.1 Considerations Before Configuring Your Firewall

Firewall configuration should be the last phase of Enterprise Manager deployment. Before you configure your firewalls, make sure you are able to log in to the Grid Control and that your Management Agents are up and monitoring targets.

If you are deploying Enterprise Manager in an environment where firewalls are already installed, open the default Enterprise Manager communication ports for all traffic until you have completed the installation and configuration processes and are certain that you are able to log in to the Oracle Enterprise Manager 10g Grid Control and that your Oracle Management Agents are up and monitoring targets.

The default communication ports for Enterprise Manager are assigned during the installation. If you modify the default ports, be sure to use the new port assignments when you configure the firewalls.

See Also: [Chapter 7, "Reconfiguring the Management Agent and Management Service"](#) for information about locating and changing the default ports for the Oracle Management Service and the Oracle Management Agent

If you are enabling Enterprise Manager Framework Security for the Management Service, the final step in that configuration process is to restrict uploads from the Management Agents to secure channels only. Before completing that step, configure your firewalls to allow both HTTP and HTTPS traffic between the Management Agent and Management Repository and test to be sure that you can log in to Enterprise Manager and that data is being uploaded to the repository.

After you have confirmed that the Management Service and Management Agents can communicate with both protocols enabled, complete the transition to secure mode and change your firewall configuration as necessary. If you incrementally configure your firewalls, it will be easier to troubleshoot any configuration problems.

3.2 Firewall Configurations for Enterprise Management Components

Your main task in enabling Enterprise Manager to work in a firewall-protected environment is to take advantage of proxy servers whenever possible, to make sure only the necessary ports are open for secure communications, and to make sure that only data necessary for running your business is allowed to pass through the firewall.

The following sections describe the ports and types of data required by Enterprise Manager in a secure, firewall-protected environment:

- [Firewalls Between Your Browser and the Grid Control](#)
- [Configuring the Management Agent on a Host Protected by a Firewall](#)
- [Configuring the Management Service on a Host Protected by a Firewall](#)
- [Firewalls Between the Management Service and the Management Repository](#)
- [Firewalls Between the Grid Control and a Managed Database Target](#)
- [Firewalls Used with Multiple Management Services](#)
- [Configuring Firewalls to Allow ICMP and UDP Traffic for Beacons](#)

3.2.1 Firewalls Between Your Browser and the Grid Control

Connections from your browser to the Oracle Enterprise Manager 10g Grid Control are performed over the default port used for your Oracle HTTP Server.

For example, the default, non-secure port for the Oracle HTTP Server is usually port 7777. If you are accessing the Grid Control using the following URL and port, then you must configure the firewall to allow the Grid Control to receive HTTP traffic over port 7777:

```
http://mgmthost.acme.com:7777/em
```

On the other hand, if you have enabled security for your Oracle HTTP Server, you are likely using the default secure port for the server, which is usually port 4443. If you are accessing the Grid Control using the following URL and port, then you must configure the firewall to allow the Grid Control to receive HTTP traffic over port 4443:

```
https://mgmthost.acme.com:4443/em
```

See also: *Oracle Application Server 10g Security Guide*

Figure 3–1 shows the typical configuration of a firewall between your browser and the Grid Control Web-based console that is rendered by the Management Service.

Figure 3–1 Firewall Between Your Browser and the Grid Control

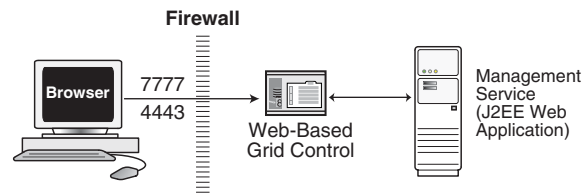

3.2.2 Configuring the Management Agent on a Host Protected by a Firewall

If your Management Agent is installed on a host that is protected by a firewall and the Management Service is on the other side of the firewall, you must perform the following tasks:

- Configure the Management Agent to use a proxy server for its uploads to the Management Service.
- Configure the firewall to allow incoming HTTP traffic from the Management Service service on the Management Agent port, which is 1830 by default, regardless of whether or not Enterprise Manager Framework Security has been enabled.

Figure 3–2 illustrates the connections the Management Agent must make when it is protected by a firewall.

Figure 3–2 Configuration Tasks When the Management Agent is Behind a Firewall

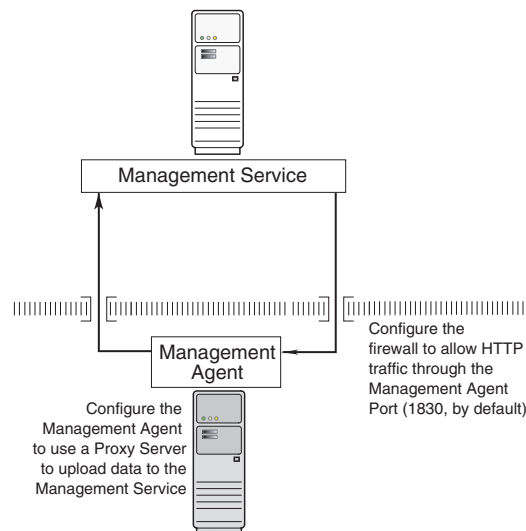

3.2.2.1 Configuring the Management Agent to Use a Proxy Server

You can configure the Management Agent to use a proxy server for its communications with a Management Service outside the firewall, or to manage a target outside the firewall:

1. Use a text editor to open the following Management Agent configuration file:

```
AGENT_HOME/sysman/config/emd.properties (UNIX)
AGENT_HOME\sysman\config\emd.properties (Windows)
```

2. Locate the following entry in the `emd.properties` file:

```
# If it is necessary to go through an http proxy server to get to the
# repository, uncomment the following two lines
#REPOSITORY_PROXYHOST=
#REPOSITORY_PROXYPORT=
```

3. Edit the following properties by removing the pound sign (#) at the start of each line and entering a value as follows:

```
# If it is necessary to go through an http proxy server to get to the
# repository, uncomment the following two lines
REPOSITORY_PROXYHOST=proxyhostname.domain
REPOSITORY_PROXYPORT=proxy_port
```

For example:

```
REPOSITORY_PROXYHOST=proxy42.acme.com
REPOSITORY_PROXYPORT=80
```

4. Save your changes and close the `emd.properties` file.
5. Stop and start the Management Agent.

See Also: ["Controlling the Oracle Management Agent"](#) on page 1-14

3.2.2.2 Configuring the Firewall to Allow Incoming Communication From the Management Service

While the Management Agents in your environment must upload data from your managed hosts to the Management Service, the Management Service must also communicate with the Management Agents. As a result, if the Management Agent is protected by a firewall, the Management Service must be able to contact the Management Agent through the firewall on the Management Agent port.

By default, the Enterprise Manager installation procedure assigns port 1830 to the Management Agent. However, if that port is occupied, the installation may assign an alternate port number.

Note: The port number for the Agent does not change when you enable Enterprise Manager Framework Security. For more information, see ["Configuring Security for the Grid Control Framework"](#) on page 2-4

In addition, administrators can change the Management Agent port after the installation.

See Also: ["Chapter 7, "Reconfiguring the Management Agent and Management Service"](#) for information about locating and changing the default ports for the Oracle Management Service and the Oracle Management Agent.

After you determine the port number assigned to the Management Agent, you must then configure the firewall to allow incoming HTTP or HTTPS traffic (depending upon whether or not you have enabled Enterprise Manager Framework Security) on that port.

See Also: Your firewall documentation for more information about opening specific ports for HTTP or HTTPS traffic.

"[Configuring Security for the Grid Control Framework](#)" on page 2-4 for information about Enterprise Manager Framework Security

3.2.3 Configuring the Management Service on a Host Protected by a Firewall

If your Management Service is installed on a host that is protected by a firewall and the Management Agents that provide management data are on the other side of the firewall, you must perform the following tasks:

- Configure the Management Service to use a proxy server for its communications to the Management Agents.
- Configure the firewall to allow incoming HTTP traffic from the Management Agents on the repository upload port.

If you have enabled Enterprise Manager Framework Security, the upload URL uses port 4888; if you have *not* enabled Enterprise Manager Framework Security, the upload port is 4889.

See also: "[Enabling Security for the Oracle Management Service](#)" on page 2-6

Figure 3-3 illustrates the connections the Management Service must make when it is protected by a firewall.

Figure 3-3 Configuration Tasks When the Management Service is Behind a Firewall

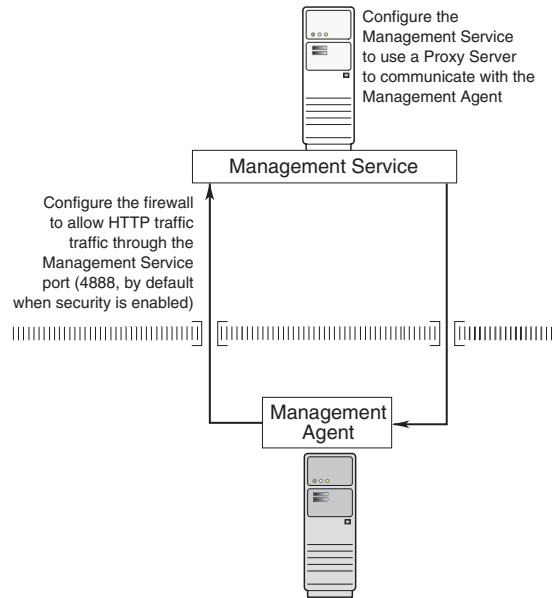

3.2.3.1 Configuring the Management Service to Use a Proxy Server

This section describes how to configure the Management Service to use a proxy server for its communications with Management Agents outside the firewall.

Note: The proxy configuration properties described in this section are same Management Service properties you must modify if your network is protected by a firewall and you want Enterprise Manager to search automatically for critical patches and patch sets. For more information, see "Specifying Patching Credentials" in the Enterprise Manager online help.

To configure the Management Service to use a proxy server:

1. Use a text editor to open the following configuration file in the Management Service home directory:

```
ORACLE_HOME/sysman/config/emoms.properties
```

2. Add the following entries to `emoms.properties` file:

```
proxyHost=proxyhost.domain
proxyPort=proxy_port
dontProxyFor=.domain1, .domain2, .domain3, ...
```

For example:

```
proxyHost=proxy42.acme.com
proxyHost=80
dontProxyFor=.acme.com, .acme.us.com
```

The `dontProxyFor` property identifies specific URL domains for which the proxy will not be used.

See Also: ["About the dontProxyfor Property"](#) on page 3-6 for guidelines on when to use the `dontProxyFor` property

3. Save your changes and close the `emoms.properties` file.
4. Stop and start the Management Service:

```
$PROMPT> ORACLE_HOME/bin/emctl stop oms
$PROMPT> ORACLE_HOME/bin/emctl start oms
```

3.2.3.2 About the dontProxyfor Property

When you configure the Management Service to use a proxy server, it is important to understand the purpose of the `dontProxyFor` property, which identifies specific URL domains for which the proxy will not be used.

For example, suppose the following were true:

- You have installed the Management Service and several Management Agents on hosts that are inside the company firewall. These hosts are in the internal `.acme.com` and `.acme.us.com` domains.
- You have installed several additional Management Agents on hosts that are outside the firewall. These hosts are installed in the `.acme.uk` domain.
- You have configured Enterprise Manager to automatically check for critical software patches on the *OracleMetaLink* Internet site.

In this scenario, you want the Management Service to connect directly to the Management Agents inside the firewall without using the proxy server. On the other hand, you want the Management Service to use the proxy server to contact the

Management Agents outside the firewall, as well as the Oracle*MetaLink* Internet site, which resides at the following URL:

```
http://metalink.oracle.com
```

The following entry in the `emoms.properties` file will prevent the Management Service from using the proxy server for connections to the Management Agents inside the firewall. Connections to Oracle*MetaLink* and to Management Agents outside the firewall will be routed through the proxy server:

```
proxyHost=proxy42.acme.com
proxyHost=80
dontProxyFor=.acme.com, .acme.us.com
```

3.2.3.3 Configuring the Firewall to Allow Incoming Management Data From the Management Agents

While the Management Agents in your environment must contact the Management Agents on your managed hosts, the Management Service must also be able to receive upload data from the Management Agents. If the the Management Service is behind a firewall, you must configure the firewall to allow the Management Agents to upload data on the upload port.

By default, the Enterprise Manager installation procedure assigns port 4889 to the as the Repository upload port. However, if that port is occupied, the installation will assign an alternate port number.

In addition, when you enable Enterprise Manager Framework Security, the upload port is automatically changed to the secure 4888 HTTPS port.

See Also: ["Configuring Security for the Grid Control Framework"](#) on page 2-4 for information about Enterprise Manager Framework Security

Administrators can also change the upload port after the installation.

See Also: [Chapter 7, "Reconfiguring the Management Agent and Management Service"](#) for information about locating and changing the default ports for the Oracle Management Service and the Oracle Management Agent.

After you determine the port number assigned to the Management Service upload port, you must then configure the firewall to allow incoming HTTP or HTTPS traffic (depending upon whether or not you have enabled Enterprise Manager Framework Security) on that port.

See Also: Your firewall documentation for more information about opening specific ports for HTTP or HTTPS traffic

3.2.4 Firewalls Between the Management Service and the Management Repository

Secure connections between the Management Service and the Management Repository are performed using features of Oracle Advanced Security. As a result, if the Management Service and the Management Repository are separated by a firewall, you must configure the firewall to allow Oracle Net firewall proxy access.

See Also: "Configuring Secure Sockets Layer Authentication" in the *Oracle Advanced Security Administrator's Guide*

Figure 3–4 shows a typical configuration of a firewall between the Management Service and the Management Repository.

Figure 3–4 Firewall Between the Management Service and the Management Repository

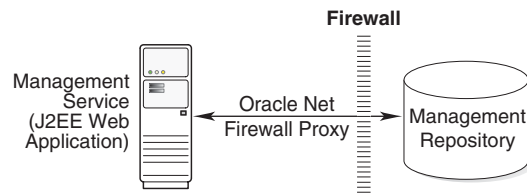

3.2.5 Firewalls Between the Grid Control and a Managed Database Target

When you are using the Grid Control to manage a database, you must log in to the database from the Grid Control in order to perform certain monitoring and administration tasks. If you are logging in to a database on the other side of a firewall, you will need to configure the firewall to allow Oracle Net firewall proxy access.

Specifically, to perform any administrative activities on the managed database, you must be sure that the firewall is configured to allow the Oracle Management Service to communicate with the database through the Oracle Listener port.

You can obtain the Listener port by reviewing the Listener home page in the Grid Control.

See Also: *Oracle Advanced Security Administrator’s Guide*

Figure 3–5 shows a typical configuration of a firewall between the Management Service and the Management Repository.

Figure 3–5 Firewall Between the Grid Control and a Managed Database Target

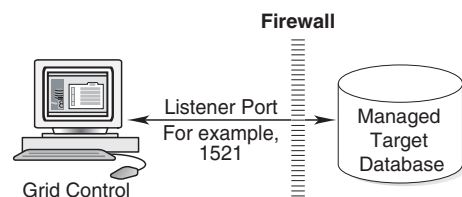

3.2.6 Firewalls Used with Multiple Management Services

Enterprise Manager supports the use of multiple Management Services that communicate with a common Management Repository. For example, using more than one Management Service can be helpful for load balancing as you expand your central management capabilities across a growing e-business enterprise.

When you deploy multiple Management Services in an environment protected by firewalls, be sure to consider the following:

- Each Management Agent is configured to upload data to one Management Service. As a result, if there is a firewall between the Management Agent and its Management Service, you must configure the firewall to allow the Management Agent to upload data to the Management Service using the upload URL.

See Also: ["Configuring the Management Agent on a Host Protected by a Firewall"](#) on page 3-3

["Configuring the Management Service on a Host Protected by a Firewall"](#) on page 3-5

- In addition, each Management Service must be able to contact any Management Agent in your enterprise so it can check for the availability of the Management Agent. As a result, you must be sure that your firewall is configured so that each Management Service you deploy can communicate over HTTP or HTTPS with any Management Agent in your enterprise.

Otherwise, a Management Service without access to a particular Agent may report incorrect information about whether or not the Management Agent is up and running.

See Also: "About Availability" in the Enterprise Manager online help for information about how Enterprise Manager determines host and Management Agent availability

3.2.7 Configuring Firewalls to Allow ICMP and UDP Traffic for Beacons

Oracle Beacons provide application performance availability and performance monitoring. They are part of the Application Performance Management features of Enterprise Manager.

See Also: "About Application Performance Management" in the Enterprise Manager Online Help

Enterprise Manager uses the industry-standard Internet Control Message Protocol (ICMP) and User Datagram Protocol (UDP) to transfer data between Beacon and the network components you are monitoring. There may be situations where your Web application components and the Beacons you use to monitor those components are separated by a firewall. In those cases, you must configure your firewall to allow ICMP, UDP, and HTTP traffic.

See Also: ["Configuring Beacons to Monitor Web Applications Over HTTPS"](#) on page 2-28

3.3 Viewing a Summary of the Ports Assigned During the Application Server Installation

As described in the previous sections of this chapter, it is important to understand and identify the ports used by each of the Oracle Enterprise Manager 10g components before you configure your firewalls.

When you install the Oracle Application Server 10g or the Oracle Enterprise Manager 10g Grid Control, you can view a list of the ports assigned during the application server installation by viewing the contents of the following file

```
ORACLE_HOME/install/portlist.ini
```

Note: The `portlist.ini` file lists the port numbers assigned during the installation. This file is not updated if port numbers are changed after the installation.

In addition, you can use the Application Server Control to view a list of all the ports in use by the application server:

1. Navigate to the Application Server home page in the Application Server Control.
2. Click **Ports**.

See Also: "Viewing and Modifying Application Server Port Assignments" in the Enterprise Manager online help

Configuring Application Performance Management

This chapter describes how to configure Application Performance Management. Application Performance Management is a feature available to users of the Oracle Enterprise Manager 10g Grid Control.

This chapter contains the following sections:

- [Before You Begin Configuring Application Performance Management](#)
- [Summary of Application Performance Management Configuration Tasks](#)
- [Configuring Transaction Performance Monitoring](#)
- [Configuring End-User Response Time Monitoring](#)
- [Configuring OC4J for Middle-Tier URL Performance Monitoring](#)

4.1 Before You Begin Configuring Application Performance Management

Before you configure Application Performance Management, you should:

- Be familiar with the concepts of systems monitoring and Application Performance Management, as described in Oracle Enterprise Manager Concepts and in the Enterprise Manager online help.
- Review the Enterprise Manager Web Application target, which is created automatically when you install the Oracle Management Service.

See Also: "Application Performance Management" in *Oracle Enterprise Manager Concepts*

"About Application Performance Management" in the Enterprise Manager online help

4.2 Summary of Application Performance Management Configuration Tasks

The configuration tasks in this chapter allow you to take advantage of four distinct features of Application Performance Management. Each of these features is available from the Web Application target home page ([Figure 4-1](#)).

Figure 4–1 Web Application Target Home Page

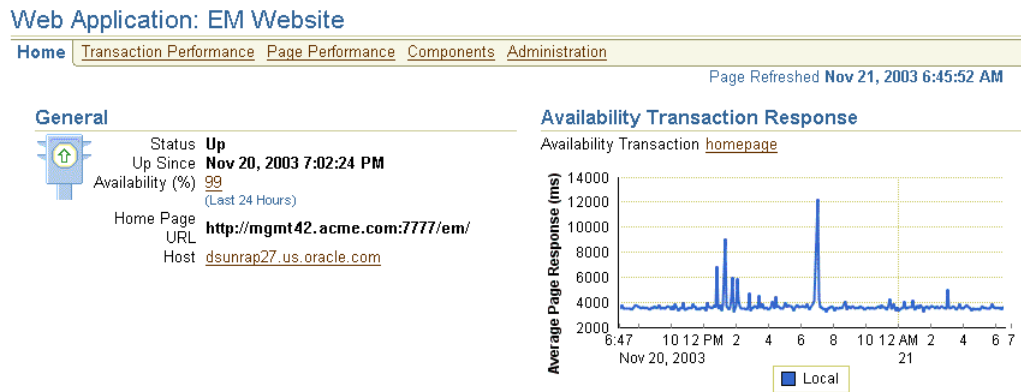

Table 4–1 describes each of the four major Application Performance Management features and how they can be accessed from the Web Application target home page.

Table 4–1 Summary of the Application Performance Management Configuration Tasks

Feature	Description	Requirements	Reference to Configuration Information
Transaction Performance Monitoring	<p>Allows you to use the Transaction Performance page to:</p> <ul style="list-style-type: none"> ■ Proactively monitor business transactions ■ Use Beacons to model the performance of various end user communities <p>Click Manage Transactions on the Transaction Performance page and play back your transactions to review performance data.</p>	Microsoft Internet Explorer 5.5 or later for creating and playing back transactions.	" Basic Configuration of Transaction Performance Monitoring " on page 4-4

Table 4–1 (Cont.) Summary of the Application Performance Management Configuration Tasks

Feature	Description	Requirements	Reference to Configuration Information
Interactive Tracing for Business Transactions	Allows you to click Manage Transactions on the Transaction Performance page and use the Play with Trace button so you can: <ul style="list-style-type: none"> Diagnose performance problems at the transaction level Interactively trace transactions and analyze breakout of J2EE server activity times (servlet/JSP, EJB, JDBC time), including individual SQL statements. 	Microsoft Internet Explorer 5.5 or later for creating and playing back transactions Oracle Application Server 10g (9.0.4) for playing back a transaction with trace to view J2EE server activity times	" Configuring Business Transaction Tracing " on page 4-4
End-User Response Time Monitoring	Allows you to use the Page Performance page to: <ul style="list-style-type: none"> Understand real end-user page response times within your application Assess the user impact of performance problems Analyze end user response times by page, domain, region, visitors, and Web server. 	Oracle Application Server Web Cache (9.0.2, 9.0.3, or 9.0.4)	" Configuring End-User Response Time Monitoring " on page 4-6
Middle-Tier URL Performance	Allows you to use the Page Performance page to: <ul style="list-style-type: none"> Diagnose root cause of performance problems View historical tracing of J2EE middle tier activity View breakouts of J2EE server processing times (servlet, JSP, EJB, JDBC times), including individual SQL statements Correlate server activity to other Web Application component metrics View the full URL processing call stack. 	Oracle Application Server 10g (9.0.4)	" Configuring OC4J for Middle-Tier URL Performance Monitoring " on page 4-14

4.3 Configuring Transaction Performance Monitoring

Configuring Transaction Performance Monitoring involves three levels of configuration:

- Basic configuration, in which you create a Web Application target and Enterprise Manager automatically begins monitoring your application based on the home page URL you provide when you create the target
- Advanced configuration, in which you optionally identify multiple remote Beacons and transactions to more accurately measure the availability and performance of you application
- Transaction tracing configuration, in which you configure Oracle Application Server Containers for J2EE (OC4J) so you can analyze the performance of the servlets, JSPs, EJB, and JDBC components that comprise your Web application

The following sections describe these configuration levels in more detail.

4.3.1 Basic Configuration of Transaction Performance Monitoring

To begin monitoring a Web application with Enterprise Manager:

1. Install an Oracle Management Agent on each of the host computers where your Web application components reside.

This step is required so you can manage all the components of your Web Application with the Oracle Enterprise Manager 10g Grid Control. For example, if your Web application depends upon a back-end database as a data source, install the Management Agent on the database host so you can manage the database from the Grid Control.

2. Create a new Web Application target in the Oracle Enterprise Manager 10g Grid Control.

See Also: "Creating Web Application Targets" in the Enterprise Manager online help

3. As you create this new Web Application target, add each of the managed targets that comprise the Web application.

For example, be sure to include components such as the Oracle HTTP Server and the OC4J instance you used to deploy your application. Also include any backend databases you are using as a data source and the Oracle Application Server Web Cache instance you are using to improve the performance of your Web application.

See Also: "About Beacons" in the Enterprise Manager online help

As soon as the Web Application appears in your list of managed targets, Enterprise Manager begins monitoring your application using the Local Beacon that is provided with the Management Agent you identified as the Monitoring Agent when you created the Web Application target.

This Local Beacon uses the home page URL you provided when you created the Web Application target to check the availability and performance of the application at periodic intervals.

Note: If the home page URL you provided while creating the Web Application target uses the HTTPS protocol, you must configure the Local Beacon so it can monitor the URL over the secure HTTPS protocol. For more information, see "[Configuring Beacons to Monitor Web Applications Over HTTPS](#)" on page 2-28

You can see the results of the home page URL transaction by viewing the Web Application home page, which includes a chart that shows the average response time of the home page URL each time it is run by the Local Beacon ([Figure 4-1](#)).

4.3.2 Advanced Configuration of Transaction Performance Monitoring

By default, when you first create a Web Application target, the Local Beacon attempts to access the application's home page URL at periodic intervals. When the Beacon successfully accesses this URL, Enterprise Manager considers your Web application available to your users.

See Also: "About Web Application Availability" in the Enterprise Manager online help

Beyond the default home page URL and Local Beacon, you can customize your Web application as follows:

- To obtain more detailed information about the performance of pages other than the home page URL, you can create additional transactions to measure the availability and performance of specific pages or features of your application.

You create additional transactions by using the Manage Transactions link on the Administration page of the Web Application target home page.

See Also: "Creating Transactions" in the Enterprise Manager online help

- To monitor the availability and performance of your application from multiple locations on your Intranet or on the Internet, you can identify additional Beacons to run your availability transactions.

You add additional Beacon targets to the Grid Control by selecting **Beacon** from the **Add** drop-down list on the Agent home page. Use the **Manage Beacons** link on the Administration page of the Web Application target home page to identify which Beacon targets are used to monitor your Web application.

See Also: "Using Beacons to Monitor Web Application Availability" in the Enterprise Manager online help

4.3.3 Configuring Business Transaction Tracing

When you use transactions to monitor your Web application, some of the transactions you create often involve application components such as servlets, Java Server Pages (JSPs), Enterprise Java Beans (EJBs), and JDBC connections. Often, the best way to solve a performance problem is to trace these more complex transaction and analyze the time spent processing each back-end application component.

Enterprise Manager provides a mechanism for tracing these transactions. Use the **Manage Transactions** link on the Administration page on the Web Application target home page to create your transactions and to trace the transactions as they are processed by the servlets, JSPs, EJBs, or JDBC connections of your application.

However, before you can take advantage of transaction tracing, you must first enable tracing for the OC4J instance used to deploy the application.

To enable tracing for an OC4J instance:

1. Navigate to the OC4J Home page in the Oracle Enterprise Manager 10g Application Server Control.
2. Click **Administration** to display the Administration page.
3. On the Administration page, click **Server Properties**.
4. In the Command Line Options section of the Server Properties page, click **Tracing Properties**.

Enterprise Manager displays the Tracing Properties page.

5. Select the three check boxes to enable general, interactive, and historical tracing. Click **Help** for more information about enabling OC4J tracing.

See Also: "Enabling OC4J Tracing" in the Enterprise Manager online help

6. Click **Apply**.
Enterprise Manager prompts you to restart the OC4J instance.
7. Click **Yes** to restart the instance.

4.4 Configuring End-User Response Time Monitoring

After you have performed the basic configuration tasks for Transaction Performance Monitoring, you can then configure End-User Response Time Monitoring.

See Also: ["Basic Configuration of Transaction Performance Monitoring"](#) on page 4-4

The following steps describe how to enable End-User Response Time Monitoring after you have configured Transaction Performance Monitoring in the Grid Control. Specifically, this procedure assumes you have created a Web Application target that includes at least one instance of Oracle Application Server Web Cache.

Note: To enable End-User Response Time Monitoring for a Web Application target, you must be using Oracle Application Server Web Cache to improve the performance of your Web application and the Oracle Application Server Web Cache instance you are using must be listed as a managed target in the Grid Control.

In addition, you must include the Oracle Application Server Web Cache target as a component of the Web Application target you created in the section ["Basic Configuration of Transaction Performance Monitoring"](#) on page 4-4.

The procedure you use to enable End-User Response Time Monitoring depends upon the version of Oracle Application Server Web Cache you are using. The following sections provide more information:

- [Configuring End-User Response Time Monitoring Using Oracle Application Server Release 2 \(9.0.4\)](#)
- [Configuring End-User Response Time Monitoring Using Earlier Versions of Oracle Application Server Web Cache](#)
- [Configuring End-User Response Time Monitoring Using Standalone Oracle Application Server Web Cache](#)

4.4.1 Configuring End-User Response Time Monitoring Using Oracle Application Server Release 2 (9.0.4)

The following sections describe how to configure and start End-User Response Time Monitoring:

- [Configuring Oracle Application Server Web Cache 9.0.4 for End-User Response Time Monitoring](#)
- [Starting and Stopping End-User Response Time Monitoring](#)

See Also: "Overview of Configuring End-User Response Time Monitoring" in the Enterprise Manager online help

4.4.1.1 Configuring Oracle Application Server Web Cache 9.0.4 for End-User Response Time Monitoring

End-User Response Time Monitoring uses data from Oracle Application Server Web Cache to gather statistics about the performance of pages within your Web applications. As a result, you must configure Oracle Application Server Web Cache so it logs your Oracle Application Server Web Cache activity and that the data is in the correct format.

When Oracle Application Server Web Cache is properly configured, End-User Response Time Monitoring can begin collecting the end-user performance data and load it into the Oracle Management Repository. After the data is collected and loaded into the repository, the performance data can be viewed on the End-User Performance page of the Web Application home page in the Oracle Enterprise Manager 10g Grid Control.

See Also: "Configuring End-User Performance Monitoring" in the *Oracle Application Server Web Cache Administrator's Guide*

To configure the Oracle Application Server Web Cache Manager:

1. Navigate to the Web Application home page in the Grid Control and click **Administration**.

Enterprise Manager displays the Web Application Administration page.

2. Click **Configure Web Application Web Caches**.

Enterprise Manager displays the Configure Web Application Web Caches page.

3. Click **Configure Logging**.

A new browser windows opens. It displays the OracleAS Web Cache Welcome page.

4. Click **Log on to Web Cache Manager**.

OracleAS Web Cache displays a dialog box so you can log in to OracleAS Web Cache Manager.

5. Log in to the Oracle Application Server Web Cache Manager.

See Also: *Oracle Application Server Web Cache Administrator's Guide* for information about the default passwords for Oracle Application Server Web Cache

You can also log in to the OracleAS Web Cache Manager using the `ias_admin` username and password you selected during the Oracle Application Server installation.

6. Enable OracleAS Web Cache logging for End-User Response Time Monitoring:
 - a. Select **Logging and Diagnostics > End-User Performance Monitoring** in the OracleAS Web Cache Manager navigator frame.

You can enable monitoring for a particular cache or for an entire site.

- b. To enable monitoring for a particular cache, select the cache from the Cache-Specific End-User Performance Monitoring section and click **Enable**.

Note: Before you can enable End-User Response Time Monitoring, you should have already configured Transaction Performance Monitoring, as described in the section "[Basic Configuration of Transaction Performance Monitoring](#)" on page 4-4.

In addition, the Oracle Application Server Web Cache instance you are using for your Web application must be included as a component of the Web Application target you created.

4.4.2.1 About the `chronos_setup` Configuration Script

Before you begin, consider the following:

- The `chronos_setup` script is installed in the `bin` directory of your Management Agent home when you install the Management Agent using the instructions in *Oracle Enterprise Manager Grid Control Installation and Basic Configuration*.
- You must run the `chronos_setup` script as an operating system user with the privilege to write to the document root of your Oracle HTTP Server.
- If you have trouble running the script, run it with no arguments to display the help text.

To enable End-User Response Time Monitoring for Oracle Application Server Web Cache 9.0.2 or Oracle Application Server Web Cache 9.0.3, you must run the `chronos_setup` script three times, each time with a different argument:

- Once to configure the document root for each Web server in your Web site
- Once to configure Oracle Application Server Web Cache
- Once to start collecting response time data

The following sections describe each step of enabling End-User Response Time Monitoring for Oracle Application Server Web Cache 9.0.2 or Oracle Application Server Web Cache 9.0.3.

4.4.2.2 Configuring the Document Root for Each Web Server

When you run the `chronos_setup` script with the `webserver` argument, the script:

- Creates a new directory inside the document root. The directory is called:

```
oracle_smp_chronos
```

- Installs two files into the `oracle_smp_chronos` directory:

```
oracle_smp_chronos.js
oracle_smp_chronos.gif
```

The `oracle_smp_chronos.js` must be installed in the document root of each Web server that serves content for your Web site.

Note: If you have more than one document root, you must run the `chronos_setup` script on each document root.

For example, if Oracle Application Server Web Cache and your Web server are on different machines and an Oracle Management Agent is present on the Web server machine, you must run the `chronos_setup` script with the `webserver` option on the Web Server host to configure the document root for the remote Web server.

If Oracle Application Server Web Cache and your Web server are installed on different machines and you have no plans to install a Management Agent or to monitor the Web server, you will need to create a directory called `oracle_smp_chronos` under the Web server document root directory, and using FTP, place the `oracle_smp_chronos.js` file in the `oracle_smp_chronos` directory.

To configure the document root for each Web server:

1. Change directory to the `/bin` directory in the Management Agent home directory.

For example:

```
$PROMPT> cd AGENT_HOME/bin
```

2. Make sure you have write access to the Web server document root directory and then run the script as follows:

```
$PROMPT> ./chronos_setup webservice location_of_the_webservice_DocumentRoot
```

An example of a Document Root is as follows:

```
$ORACLE_HOME/Apache/Apache/htdocs
```

To find the location of the document root:

- Log in to the Oracle Application Server Release 2 (9.0.2) Enterprise Manager Web site and navigate to the Oracle HTTP Server Home Page. The document root is displayed in the General section of the HTTP Server Home Page.

OR

- Use a text editor or a command-line search utility to search for the term `DocumentRoot` in the following Oracle HTTP Server configuration file:

```
$ORACLE_HOME/Apache/Apache/conf/httpd.conf
```

4.4.2.3 Configuring Oracle Application Server Web Cache for End-User Response Time Monitoring

To configure Oracle Application Server Web Cache for End-User Response Time Monitoring, you run the `chronos_setup` script with the `webcache` argument. The script sets up Oracle Application Server Web Cache for End-User Response Time Monitoring, and stops and restarts Oracle Application Server Web Cache automatically.

To configure Oracle Application Server Web Cache for End-User Response Time Monitoring:

1. Make sure you have write access to the Oracle Application Server Web Cache directory.

For example, if Web Cache is installed in an Oracle Application Server home directory, you will need access to the `IAS_HOME/webcache` directory.

2. Change directory to the `/bin` directory in the Management Agent home directory.

For example:

```
$PROMPT> cd /private/agent_home/bin
```

3. Run the script as follows:

```
$PROMPT> ./chronos_setup webcache webcache_installation_directory
```

Note: After running `chronos_setup`, if you cannot restart Oracle Application Server Web Cache, back out of the configuration process by copying the following files back to their original name and location:

- `internal.xml<timestamp>`
 - `webcache.xml<timestamp>`
-
-

4.4.2.4 Starting End-User Response Time Monitoring

To start End-User Response Time Monitoring, you run the `chronos_setup` script with the `collection` argument. The script creates a collection file for the specified target and restarts the agent.

To start End-User Response Time Monitoring:

1. Log in as the user who installed the Management Agent so you have write access to the following directory:

```
AGENT_HOME/sysman/emd/collection
```

2. Change directory to the `/bin` directory in the Management Agent home directory.

For example:

```
$PROMPT> cd AGENT_HOME/bin
```

3. Locate the name of the Oracle Application Server Web Cache target.

You can locate the name of the target in one of three ways:

- From the Oracle Enterprise Manager 10g Grid Control, locate the Oracle Application Server Web Cache target on the Targets tab. The name listed in the first column of the Target table is the name you must enter as an argument to the `chronos_setup` script. Note the use of spaces and underscores.
- Search the contents of the `targets.xml` configuration file, which lists all the targets managed by the Management Agent. Locate the Oracle Application Server Web Cache entry in the file and use the `NAME` attribute for the Web Cache target. The `targets.xml` file is located in the following directory of the Management Agent home:

```
AGENT_HOME/sysman/emd/targets.xml
```

- Use the `emctl config agent listtargets` command to list the target names and target types currently being monitored by the Management Agent.

See Also: ["Listing the Targets on a Managed Host"](#) on page 1-23

4. Start the collection for the Oracle Application Server Web Cache target by running the script as follows:

```
$PROMPT> ./chronos_setup collection webcache_targetname
```

Note: If the name of the Oracle Application Server Web Cache target includes spaces, you must use quotation marks around the name.

See Also: "Creating Web Application Targets" in the Enterprise Manager online help

4.4.3 Configuring End-User Response Time Monitoring Using Standalone Oracle Application Server Web Cache

Oracle Application Server Web Cache is available as a standalone download from the Oracle Technology Network (OTN). The standalone version of Oracle Application Server Web Cache allows you to improve the performance and reliability of your Web server even if you are not using Oracle Application Server.

If you are using standalone Oracle Application Server Web Cache with a third-party Web server, you can still manage Oracle Application Server Web Cache using the Oracle Enterprise Manager 10g Grid Control. As a result, you can also use End-User Response Time Monitoring to monitor the Web applications that your users access through Oracle Application Server Web Cache.

Configuring End-User Response Time Monitoring for standalone Oracle Application Server Web Cache involves the following steps, which are described in the following sections:

- [Installing Standalone Oracle Application Server Web Cache](#)
- [Configuring Standalone Oracle Application Server Web Cache](#)
- [Enabling End-User Response Time Monitoring for Standalone Oracle Application Server Web Cache](#)

4.4.3.1 Installing Standalone Oracle Application Server Web Cache

To install the standalone version of Oracle Application Server Web Cache:

1. Navigate to the Oracle Technology Network (OTN):
`http://otn.oracle.com/software/content.html`
2. Locate and select the Oracle Application Server Web Cache download option and follow the links for your operating system.
3. Use the instructions on the OTN Web site to download Oracle Application Server Web Cache.
4. Use the instructions in the Web Cache readme file to install Oracle Application Server Web Cache in its own Oracle Home.

4.4.3.2 Configuring Standalone Oracle Application Server Web Cache

End-User Response Time Monitoring uses data from Oracle Application Server Web Cache to gather statistics about the performance of pages within your Web applications. As a result, Enterprise Manager obtains End-User Response Time Monitoring data only when Oracle Application Server Web Cache is configured to improve the performance and reliability of your Web server.

See Also: *Oracle Application Server Web Cache Administrator's Guide* for complete instructions for configuring Oracle Application Server Web Cache

Specifically, you must perform the following Oracle Application Server Web Cache configuration tasks:

1. Change the default listening port of your HTTP Server (for example, 7777) to a new port number (for example, 7778) and restart the HTTP Server.

See Also: "Specifying Listening Addresses and Ports" in the Enterprise Manager online help if you are using Oracle HTTP Server and managing the server with Enterprise Manager

Oracle HTTP Server Administrator's Guide for information about modifying the `httpd.conf` file if you are not managing the server with Enterprise Manager

2. Start Oracle Application Server Web Cache and its administration tools.
3. Configure Oracle Application Server Web Cache so it receives requests on the default port previously assigned to your Web server (for example, 7777).
4. Configure Oracle Application Server Web Cache so it so it sends cache misses to your newly defined Web server default port number (for example, 7778), which is also referred to as the origin server.
5. Create an Oracle Application Server Web Cache *site* and map the site to your origin server.
6. Apply the changes and restart Oracle Application Server Web Cache.
7. Test the installation to be sure Oracle Application Server Web Cache and your Web server are working properly.

4.4.3.3 Enabling End-User Response Time Monitoring for Standalone Oracle Application Server Web Cache

After you have installed and configured Oracle Application Server Web Cache and tested the configuration to be sure your Web site data is being cached, you can then enable End-User Response Time Monitoring.

The procedure for enabling End-User Response Time Monitoring is similar to the procedures documented earlier in this chapter; however, the steps vary depending upon the version of standalone Oracle Application Server Web Cache you are using.

To enable End-User Response Time Monitoring for standalone Oracle Application Server Web Cache:

1. Perform the basic configuration tasks to enable Transaction Performance Monitoring.

Basic configuration of Transaction Performance Monitoring involves adding the Oracle Application Server Web Cache target and creating a Web Application target.

See Also: ["Basic Configuration of Transaction Performance Monitoring"](#) on page 4-4

2. Use the Oracle Application Server Web Cache Manager to configure End-User Response Time Monitoring, and use the Grid Control to start End-User Response Time Monitoring, as described in ["Configuring End-User Response Time Monitoring Using Oracle Application Server Release 2 \(9.0.4\)"](#) on page 4-6.

4.4.4 Confirming that End-User Response Time Monitoring is Enabled

When End-User Response Time Monitoring is properly enabled, you will see response time data on the End-User Performance tab of the Web Application home page as shown in [Figure 4-2](#).

However, note that it may take some time for Enterprise Manager to gather and display the end-user monitoring data. You must also be sure that enough users are accessing your Web application so that enough end-user performance data can be gathered and stored in the Oracle Management Repository.

See Also: "Verifying and Troubleshooting End-User Response Time Monitoring" in the Enterprise Manager online help for more information about confirming that End-User Response Time Monitoring is configured and operating correctly.

Figure 4-2 End-User Performance Data on the Web Application Home Page

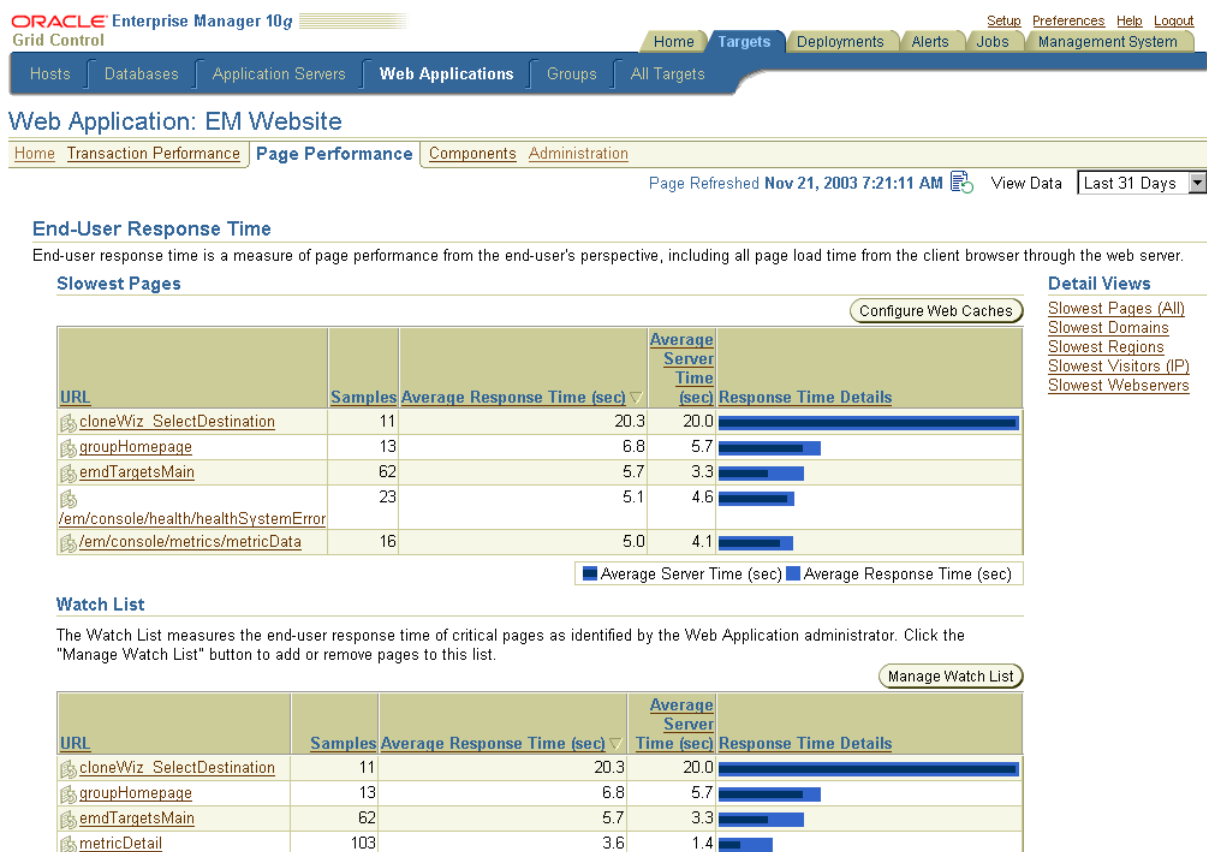

4.5 Configuring OC4J for Middle-Tier URL Performance Monitoring

When combined with the tracing features of OC4J, Application Performance Management can gather critical middle-tier performance data about your Web application. Enterprise Manager displays this performance data on the Web Application Performance Page, just below the End-User Response Time Monitoring data.

This feature can be instrumental when you are diagnosing application server and back-end performance issues.

See Also: "About Monitoring Page Performance" in the Enterprise Manager online help

Before you can begin collecting middle-tier URL performance data and before this data can appear on the Web Application Page Performance page, you must first enable the logging and tracing capabilities of the OC4J instance that you used to deploy your application.

For more information, see the following:

- [Configuring OC4J Tracing for Middle-Tier URL Monitoring](#)
- [Additional Configuration for Monitoring UIX Applications](#)

4.5.1 Configuring OC4J Tracing for Middle-Tier URL Monitoring

To configure OC4J tracing so you can begin collecting middle-tier URL performance data:

1. Navigate to the Web Application home page and click **Administration**.
2. Click **Configure Web Application OC4Js**.
Enterprise Manager displays the Configure Web Application OC4Js page.
3. For the OC4J instance that you used to deploy your application, select the check box in the **Collecting** column.
4. In the **Interval (minutes)** column, enter the interval at which to collect OC4J tracing data.

The recommended interval setting is 60 minutes.

5. Click **Enable Logging**.

Enterprise Manager opens another browser window and displays the Tracing Properties page for the OC4J instance in the Application Server Control.

If you are prompted to log in to the Application Server Control, enter the credentials for the `ias_admin` administrator's account.

6. Select the following options on the Tracing Properties page:
 - **Enable JDBC/SQL Performance Details**
 - **Enable Interactive Trace**
 - **Enable Historical Trace**

You can use the default values for most of the tracing properties. However, Oracle recommends that you set the **Frequency to Generate Trace File (seconds)** field to 3600 seconds (equivalent to 60 minutes).

Note that modifying the value in the **Trace File Directory** field is not supported.

7. Click **Apply**.

If this is the first time you are enabling OC4J tracing for this application server, Enterprise Manager displays a message stating that the transtrace application is being deployed. The Application Server Control then prompts you to restart the OC4J instance.

8. Click **Yes** to restart the instance and enable the tracing properties.
9. Return to the Grid Control.

Middle-Tier Performance data should begin to appear on the Web Application Page Performance page as soon as data for the OC4J instance is collected and uploaded into the Management Repository.

4.5.2 Additional Configuration for Monitoring UIX Applications

If you used Oracle User Interface XML (UIX) to build your application, there is an additional configuration step you must perform before you can monitor the middle-tier URLs of your application.

See Also: Your JDeveloper documentation for information on using UIX to develop Web applications

Before you can monitor the middle-tier URLs of your UIX application, you must do the following:

1. Enable tracing for the OC4J instance you used to deploy your application, as described in "[Configuring OC4J Tracing for Middle-Tier URL Monitoring](#)" on page 4-15.
2. Locate the following configuration file in the Application Server home directory where you deployed your UIX application:

```
$ORACLE_HOME/j2ee/OC4J_instance_name/config/oc4j.properties
```

For example, if you deployed your application in the OC4J instance called "home," locate the following configuration file:

```
$ORACLE_HOME/j2ee/home/config/oc4j.properties
```

3. Open the `oc4j.properties` file using your favorite text editor and add the following line to the end of the file:

```
oracle.dms.transtrace.dollarstrippingenabled=true
```

4. Save your changes and close the `oc4j.properties` file.
5. Restart the OC4J instance.

Locating and Configuring Enterprise Manager Log Files

When you install the Oracle Management Agent or the Oracle Management Service, Enterprise Manager automatically configures the system to save certain informational, warning, and error information to a set of log files.

Log files can help you troubleshoot potential problems with an Enterprise Manager installation. They provide detailed information about the actions performed by Enterprise Manager and whether or not any warnings or errors occurred.

This chapter not only helps you locate and review the contents of Enterprise Manager log files, but also includes instructions for configuring the log files to provide more detailed information to help in troubleshooting or to provide less detailed information to save disk space.

This chapter contains the following sections:

- [Locating and Configuring Management Agent Log and Trace Files](#)
- [Locating and Configuring Management Service Log and Trace Files](#)

5.1 Locating and Configuring Management Agent Log and Trace Files

The following sections provide information on the log and trace files for the Oracle Management Agent:

- [About the Management Agent Log and Trace Files](#)
- [Locating the Management Agent Log and Trace Files](#)
- [About Management Agent Rollover Files](#)
- [Controlling the Size and Number of Management Agent Log and Trace Files](#)
- [Controlling the Size and Number of Fetchlet Log and Trace Files](#)
- [Controlling the Contents of the Fetchlet Trace File](#)

5.1.1 About the Management Agent Log and Trace Files

Oracle Management Agent log and trace files store important information that support personnel can later use to troubleshoot problems. The Management Agent uses three types of log files:

- The Management Agent log file (`emagent.log`)

The Agent saves information to the log file when the Agent performs an action (such as starting, stopping, or connecting to a Management Service) or when the

Agent generates an error (for example, when the Agent cannot connect to the Management Service).

- The Management Agent trace file (`emagent.trc`)

The Management Agent trace file provides an advanced method of troubleshooting that can provide support personnel with even more information about what actions the Agent was performing when a particular problem occurred.

- The Management Agent startup log file (`emagent.nohup`)

The Management Agent saves information to the startup log file when there is a problem starting the agent. This file is updated by the Management Agent Watchdog Process. When the Watchdog Process logs any problems it finds to this file.

See Also: ["About the Management Agent Watchdog Process"](#) on page 7-4

In addition, Enterprise Manager also provides a log file and a trace file for the fetchlets, which are software programs used by the Management Agent for certain data-gathering tasks:

- `emagentfetchlet.log`
- `emagentfetchlet.trc`

5.1.2 Locating the Management Agent Log and Trace Files

The Management Agent log files are stored in the following directory when you install the Management Agent:

`AGENT_HOME/sysman/log/`

See Also: [Chapter 1, "Introduction to Enterprise Manager Advanced Configuration"](#) for information about locating the Agent home directory.

5.1.3 About Management Agent Rollover Files

Both the Management Agent log file and the Management Agent trace file are designed to increase in size over time as information is written to the files. However, they are also designed to reach a maximum size. When the files reach the predefined maximum size, the Management Agent renames (or rolls) the logging or trace information to a new file name and starts a new log or trace file. This process keeps the log files from growing too large.

To be sure you have access to important log or trace file information, the Management Agent will rollover the log and trace files four times by default. When it rolls the log or trace file over the fourth time, the Agent deletes the oldest rollover file.

As a result, you will often see a total of four log files and four trace files in the log directory. The following example shows three archived trace files and the current trace file in the `AGENT_HOME/sysman/log` directory:

```
emagent.trc
emagent.trc.1
emagent.trc.2
emagent.trc.3
```

5.1.4 Controlling the Size and Number of Management Agent Log and Trace Files

You can control how large the log file and the trace file can get before the Management Agent creates a rollover file. You can also control how many rollover files are created before the Management Agent deletes any logging or tracing data.

To control the size and number of Management Agent Log and Trace Files:

1. Stop the Management Agent.

See Also: ["Starting, Stopping, and Checking the Status of the Management Agent on UNIX"](#) on page 1-14

2. Locate the `emd.properties` file, which is located in the following directory:

`AGENT_HOME/sysman/config/` (UNIX)

`AGENT_HOME\sysman\config` (Windows)

3. Use a text editor to open the `emd.properties` file.
4. Use the information in [Table 5–1](#) to locate and modify the Agent logging and tracing properties in the `emd.properties` file.
5. Restart the Management Agent.

Table 5–1 Management Agent Log and Trace File Properties

Property	Purpose	Example
<code>LogFilewithPID</code>	When set to TRUE, this property appends the process ID of the Management Agent to the log file name. This makes it easier to identify the process ID of the Management Agent you are monitoring.	<code>LogFilewithPID=true</code>
<code>LogFileMaxSize</code>	When the Agent log file reaches this size (in kilobytes), the Management Agent copies the logging data to a new rollover file and creates a new <code>emagent.log</code> logging file.	<code>LogFileMaxSize=4096</code>
<code>LogFileMaxRolls</code>	By the default, the Agent will rollover the log file four times before it deletes any logging data. The number of rollover files is controlled by this property.	<code>LogFileMaxRolls=4</code>
<code>TrcFileMaxSize</code>	When the Agent trace file reach this size (in kilobytes), the Management Agent copies the logging data to a new rollover file and creates a new <code>emagent.trc</code> logging file.	<code>TrcFileMaxSize=4096</code>
<code>TrcFileMaxRolls</code>	By the default, the Agent will rollover the trace file four times before it deletes any tracing data. The number of rollover files is controlled by this property.	<code>TrcFileMaxRolls=4</code>

5.1.5 Controlling the Contents of the Management Agent Trace File

To modify the amount of information saved in the Management Agent trace file:

1. Stop the Management Agent.

See Also: ["Starting, Stopping, and Checking the Status of the Management Agent on UNIX"](#) on page 1-14

2. Locate the `emd.properties` file, which is located in the following directory:

`AGENT_HOME/sysman/config`

3. Open the `emd.properties` file using your favorite text editor and look for the following entries near the bottom of the file:

```

tracelevel.main=WARN
tracelevel.emdSDK=WARN
tracelevel.emdSDK.util=WARN
tracelevel.ResMonitor=WARN
tracelevel.Dispatcher=WARN
tracelevel.ThreadPool=WARN
tracelevel.pingManger=WARN
.
.
.
    
```

Each of these properties controls the level of logging detail for the various subcomponents of the Management Agent.

4. Modify the amount of information that is included in the trace file by replacing the WARN value for each property to one of the values shown in [Table 5-2](#).

Note: The values described in [Table 5-2](#) are case-sensitive.

5. Restart the Management Agent.

Table 5-2 Enterprise Manager Component Tracing Levels

Level	Purpose
ERROR	Include only critical errors in the trace file. This setting generates the least amount of tracing data. The trace file will likely grow at a relatively slow rate when you select this logging level.
WARN	Include warning information, in addition to critical errors.
INFO	Include informational messages, in addition to warning and critical error information.
DEBUG	Include debugging information, as well as informational tracing, warning, and critical errors. This setting generates the greatest amount of tracing data. Note: The trace file will likely grow at a relatively fast rate when you select this logging level.

5.1.6 Controlling the Size and Number of Fetchlet Log and Trace Files

Like the Management Agent log and trace files, the Management Agent fetchlet log and trace files are designed to reach a maximum size before the Management Agent renames (or rolls) the information to a new file name and starts a new log or trace file.

To control the maximum size of the Management Agent fetchlet log and trace files, as well as the number of rollover files:

1. Stop the Management Agent.

See Also: ["Starting, Stopping, and Checking the Status of the Management Agent on UNIX"](#) on page 1-14

2. Locate the `emagentlogging.properties` file in the following directory:

`AGENT_HOME/sysman/config`

3. Open the `emagentlogging.properties` file with a text editor and modify the entries described in [Table 5-3](#).

4. Restart the Management Agent.

Table 5-3 Management Agent Servlet Log and Trace File Properties

Property	Purpose	Example
log4j.appender. emagentlogAppender. MaxFileSize	When the fetchlet log file reaches this size, the Management Agent copies the logging data to a new rollover file and creates a new <code>emagentfetchlet.log</code> file.	log4j.appender. emagentlogAppender. MaxFileSize=2000000
log4j.appender. emagentlogAppender. MaxBackupIndex	This optional property indicates how many times the Management Agent will rollover the fetchlet log file to a new file name before deleting logging data. Note: Because the log file does not contain as much data as the trace file, it is usually not necessary to create more than one rollover file. As a result, this entry is not included in the properties file by default.	log4j.appender.emagentlogAppender. MaxBackupIndex=1
log4j.appender. emagenttrcAppender. MaxFileSize	When the fetchlet trace file reaches this size, the Management Agent copies the logging data to a new rollover file and creates a new <code>emagentfetchlet.trc</code> log file.	log4j.appender. emagenttrcAppender. MaxFileSize=5000000
log4j.appender. emagenttrcAppender. MaxBackupIndex	This property indicates how many times the Management Agent will rollover the trace file to a new file name before deleting tracing data.	log4j.appender. emagenttrcAppender. MaxBackupIndex=10

5.1.7 Controlling the Contents of the Fetchlet Trace File

By default, the Management Agent will save all critical and warning messages generated by the Management Agent fetchlets to the `emagentfetchlet.trc` file. However, you can adjust the amount of logging information that the fetchlets generate.

To change the amount of tracing information generated by the Management Agent fetchlets:

1. Stop the Management Agent.

See Also: ["Starting, Stopping, and Checking the Status of the Management Agent on UNIX"](#) on page 1-14

2. Locate the `emagentlogging.properties` file in the following directory:

`AGENT_HOME/sysman/config`

3. Open the `emagentlogging.properties` file with a text editor and locate the following entry:

```
log4j.rootCategory=WARN, emagentlogAppender, emagenttrcAppender
```

4. Change the value of the `log4j.rootCategory` parameter to one of the values shown in [Table 5-2](#).

Note: The the values described in [Table 5-2](#) are case-sensitive.

5. Restart the Management Agent.

5.2 Locating and Configuring Management Service Log and Trace Files

The following sections describe how to locate and configure the Management Service log files:

- [Locating the Management Service Log and Trace Files](#)
- [Controlling the Size and Number of Management Service Log and Trace Files](#)
- [Controlling the Contents of the Management Service Trace File](#)

5.2.1 About the Management Service Log and Trace Files

Oracle Management Service log and trace files store important information that support personnel can later use to troubleshoot problems. The Management Service uses three types of log files:

- The Management Service log file (`emoms.log`)
The Oracle Management Service saves information to the log file when the Management Service performs an action (such as starting or stopping) or when the Management Service generates an error.
- The Management Service trace file (`emoms.trc`)
The Management Service trace file provides an advanced method of troubleshooting that can provide support personnel with even more information about what actions the Management Service was performing when a particular problem occurred.

5.2.2 Locating the Management Service Log and Trace Files

The Management Service log and trace files are stored in the following directory inside the Oracle Application Server Home where the Oracle Management Service is installed and deployed:

```
AS_HOME/sysman/log/
```

5.2.3 Controlling the Size and Number of Management Service Log and Trace Files

The Management Service log and trace files increases in size over time as information is written to the files. However, the files are designed to reach a maximum size. When the files reach the predefined maximum size, the Management Service renames (or rolls) the logging information to a new file name and starts a new log or trace file. This process keeps the log and trace files from growing too large.

As a result, you will often see multiple log and trace files in the Management Service log directory. The following example shows one archived log file and the current log file in the `AS_HOME/sysman/log` directory:

```
emoms.log
emoms.log.1
```

To control the maximum size of the Management Service log and trace files, as well as the number of rollover files:

1. Stop the Management Service.

See Also: ["Controlling the Oracle Management Service"](#) on page 1-16

2. Locate the `emomslogging.properties` file in the following directory:

```
AS_HOME/sysman/config
```

3. Open the `emomslogging.properties` file with a text editor and modify the entries described in [Table 5-4](#).
4. Restart the Management Service.

Table 5-4 Management Service Log File Properties in the `emomslogging.properties` File

Property	Purpose	Example
<code>log4j.appender.emlogAppender.MaxFileSize</code>	When the Management Service log file reaches this size, the Management Service copies the logging data to a new rollover file and creates a new <code>emoms.log</code> log file.	<code>log4j.appender.emdAppender.MaxFileSize=2000000</code>
<code>log4j.appender.emlogAppender.MaxBackupIndex</code>	This optional property indicates how many times the Management Service will rollover the log file to a new file name before deleting logging data. Note: Because the log file does not contain as much data as the trace file, it is usually not necessary to create more than one rollover file. As a result, this entry is not included in the properties file by default.	<code>log4j.appender.emdAppender.MaxBackupIndex=1</code>
<code>log4j.appender.emtrcAppender.MaxFileSize</code>	When the Management Service trace file reaches this size, the Management Service copies the logging data to a new rollover file and creates a new <code>emoms.trc</code> log file.	<code>log4j.appender.emtrcAppender.MaxFileSize=5000000</code>
<code>log4j.appender.emtrcAppender.MaxBackupIndex</code>	This property indicates how many times the Management Services will rollover the trace file to a new file name before deleting tracing data.	<code>log4j.appender.emtrcAppender.MaxBackupIndex=10</code>

5.2.4 Controlling the Contents of the Management Service Trace File

By default, the Management Service will save all critical and warning messages to the `emoms.trc` file. However, you can adjust the amount of logging information that the Management Service generates.

To change the amount of logging information generated by the Management Service:

1. Stop the Management Service.

See Also: ["Controlling the Oracle Management Service"](#) on page 1-16

2. Locate the `emomslogging.properties` file in the following directory:

`AS_HOME/sysman/config`

3. Open the `emomslogging.properties` file with a text editor and locate the following entry:

`log4j.rootCategory=WARN, emlogAppender, entrcAppender`

4. Modify the value of the `log4j.rootCategory` parameter to one of the values shown in [Table 5-2](#).

Note: The the values described in [Table 5-2](#) are case-sensitive.

5. Restart the Management Service.

Maintaining and Troubleshooting the Repository

This chapter describes maintenance and troubleshooting techniques for maintaining a well-performing Management Repository.

Specifically, this chapter contains the following sections:

- [Management Repository Deployment Guidelines](#)
- [Management Repository Data Retention Policies](#)
- [Requirement to Manually Analyze Specific Management Repository Tables](#)
- [Changing the SYSMAN Password](#)
- [Dropping and Recreating the Management Repository](#)
- [Troubleshooting Management Repository Creation Errors](#)

6.1 Management Repository Deployment Guidelines

To be sure that your management data is secure, reliable, and always available, consider the following settings and configuration guidelines when you are deploying the Management Repository:

- Install a RAID-capable Logical Volume Manager (LVM) on the system where the Management Repository resides. At a minimum the operating system must support disk mirroring and stripping. Configure all the repository data files with some redundant configuration.
- Use Real Application Clusters to provide the highest levels of availability for the repository.
- If you use Enterprise Manager to alert administrators of errors or availability issues in a production environment, be sure that the Grid Control Framework components are configured with the same level of availability. At a minimum, consider using Oracle Data Guard to mirror the Management Repository database. Configure the Data Guard environment for no data loss.

See Also: *Oracle High Availability Architecture and Best Practices*

Oracle Data Guard Concepts and Administration

- You should configure your database to use at least three redo logs no less than 100MB each in size.

- Oracle strongly recommends that archive logging be turned on and that a comprehensive backup strategy be in place prior to an Enterprise Manager implementation going live in a production environment. The backup strategy should include both incremental and full backups as required.

See Also: *Oracle Enterprise Manager Grid Control Installation and Basic Configuration* for information about the database initialization parameters required for Management Repository

- If you are using an Oracle9i database with Partitioning, you should manually analyze three specific tables in the Management Repository each time the number of targets you manages changes significantly.

See Also: ["Requirement to Manually Analyze Specific Management Repository Tables"](#) on page 6-5

6.2 Management Repository Data Retention Policies

When the various components of Enterprise Manager are configured and running efficiently, the Oracle Management Service gathers large amounts of raw data from the Agents running on your managed hosts and loads that data into the Management Repository. This data is the raw information that is later aggregated, organized, and presented to you in Enterprise Manager Console.

After the Oracle Management Service loads information into the Repository; Enterprise Manager aggregates and purges the data over time.

The following sections describe:

- The default aggregation and purging policies used to maintain data in the Management Repository
- How you can modify how long the data is retained before it is aggregated and then purged from the repository

6.2.1 Management Repository Default Aggregation and Purging Policies

Enterprise Manager aggregates your management data by hour and by day to minimize the size of the Management Repository. Before the data is aggregated, each data point is stored in a raw data table. Raw data is rolled up, or aggregated, into a one-hour aggregated metric table. One-hour records are then rolled up into a one-day table.

After Enterprise Manager aggregates the data, the data is then considered eligible for purging. A certain period of time has to pass for data to actually be purged. This period of time is called the retention time.

The raw data, with the highest insert volume, has the shortest default retention time, which is set to 7 days. As a result, 7 days after it is aggregated into a one-hour record, a raw data point is eligible for purging.

One-hour aggregate data records are purged 31 days after they are rolled up to the one-day data table. The highest level of aggregation, one day, is kept for 365 days.

The default data retention policies are summarized in [Table 6-1](#).

Table 6–1 Default Repository Purging Policies

Aggregate Level	Retention Time
Raw metric data	7 days
One-hour aggregated metric data	31 days
One-day aggregated metric data	365 days

Note: When you delete a target, Enterprise Manager automatically deletes all historical metric data in the next repository purge interval.

If you have configured and enabled Application Performance Management, Enterprise Manager also gathers, saves, aggregates, and purges response time data. The response time data is purged using policies similar to those used for metric data. The Application Performance Management purging policies are shown in [Table 6–2](#).

Table 6–2 Default Repository Purging Policies for Application Performance Management Data

Aggregate Level	Retention Time
Raw response time data	24 hours
One-hour aggregated response time data	7 days
One-hour distribution response time data	24 hours
One-day aggregated response time data	31 days
One-day distribution aggregated response time data	31 days

6.2.2 Management Repository Default Aggregation and Purging Policies for Other Management Data

Besides the metric data and Application Performance Monitoring data, other types of Enterprise Manager data accumulates over time in the Management Repository. These other types of data, such as severities, availability records, and string metric history are retained indefinitely.

For example, the last availability record for a target will also remain in the repository indefinitely, so the last known state of a target is preserved.

6.2.3 Modifying the Default Aggregation and Purging Policies

The Enterprise Manager default aggregation and purging policies were designed to provide the most available data for analysis while still providing the best performance and disk-space requirements for the repository. As a result, you should not modify these policies to improve performance or increase your available disk space. Modifying these default policies can affect the performance of the repository and have adverse reactions on the scalability of your Enterprise Manager installation.

However, if you plan to extract or review the raw or aggregated data using data analysis tools other than Enterprise Manager, you may want to increase the amount of

raw or aggregated data available in the repository. You can accomplish this by increasing the retention times for the raw or aggregated data.

To modify the default retention time for each level of management data in the repository, you must insert additional rows into the MGMT_PARAMETERS table in the repository database. Table 6-3 shows the parameters you must insert into the MGMT_PARAMETERS table to modify the retention time for each of the raw data and aggregate data tables.

Table names that contain "_RT_" indicate tables used for Application Performance Monitoring response time data. In the **Table Name** column, replace *datatype* with one of the three response time data types: DOMAIN, IP, or URL.

Table 6-3 Parameters for Modifying Default Data Retention Times in the Management Repository

Table Name	Parameter in MGMT_PARAMETERS Table	Default Retention Value
MGMT_METRICS_RAW	mgmt_raw_keep_window	7 days
MGMT_METRICS_1HOUR	mgmt_hour_keep_window	31 days
MGMT_METRICS_1DAY	mgmt_day_keep_window	365 days
MGMT_RT_METRICS_RAW	mgmt_rt_keep_window	24 hours
MGMT_RT_ <i>datatype</i> _1HOUR	mgmt_rt_hour_keep_window	7 days
MGMT_RT_ <i>datatype</i> _1DAY	mgmt_rt_day_keep_window	31 days
MGMT_RT_ <i>datatype</i> _DIST_1HOUR	mgmt_rt_dist_hour_keep_window	24 hours
MGMT_RT_ <i>datatype</i> _DIST_1DAY	mgmt_rt_dist_day_keep_window	31 days

For example, to change the default retention time for the table MGMT_METRICS_RAW from seven days to 14 days:

1. Use SQL*Plus to connect to the repository database as the Management Repository user.

The default Management Repository user is `sysman`.

2. Enter the following SQL to insert the parameter and change the default value:

```
INSERT INTO MGMT_PARAMETERS (PARAMETER_NAME, PARAMETER_VALUE)
VALUES ('mgmt_raw_keep_window', '14');
```

Similarly, to change from the default retention time for all of the MGMT_RT_*datatype*_1DAY tables from 31 days to 100 days:

1. Use SQL*Plus to connect to the repository database as the Management Repository user.

The default Management Repository user is `sysman`.

2. Enter the following SQL to insert the parameter and change the default value:

```
INSERT INTO MGMT_PARAMETERS (PARAMETER_NAME, PARAMETER_VALUE)
VALUES ('mgmt_rt_day_keep_window', '100');
```

6.2.4 Modifying Data Retention Policies When Targets Are Deleted

By default, when you delete a target from the Grid Control, Enterprise Manager automatically deletes all target data, including raw metric data and aggregated data, from the Management Repository.

However, deleting raw and aggregated metric data for database and other data-rich targets is a resource consuming operation. Targets can have hundreds of thousands of rows of data and the act of deleting this data can degrade performance of Enterprise Manager for the duration of the deletion, especially when several targets are deleted at once.

To avoid this resource-consuming operation, you can prevent Enterprise Manager from performing this task each time you delete a target. When you prevent Enterprise Manager from performing this task, the metric data for deleted targets is not purged as part of target deletion task; instead, it is purged as part of the regular purge mechanism, which is more efficient.

In addition, Oracle strongly recommends that you do not add new targets with the same name and type as the deleted targets within 24 hours of target deletion. Adding a new target with the same name and type will result in the Grid Control showing data belonging to the deleted target for the first 24 hours.

To disable raw metric data deletion:

1. Use SQL*Plus to connect to the repository as the Management Repository user.

The default repository user is SYSMAN. For example:

```
SQL> connect sysman/oldpassword;
```

2. To disable metric deletion, run the following SQL.

```
SQL> EXEC MGMT_ADMIN.DISABLE_METRIC_DELETION();  
SQL> COMMIT;
```

To enable metric deletion at a later point, run the following SQL:

1. Use SQL*Plus to connect to the repository as the Management Repository user.

The default repository user is SYSMAN. For example:

```
SQL> connect sysman/oldpassword;
```

2. To enable metric deletion, run the following SQL.

```
SQL> EXEC MGMT_ADMIN.ENABLE_METRIC_DELETION();  
SQL> COMMIT;
```

6.3 Requirement to Manually Analyze Specific Management Repository Tables

If the Management Repository is stored in an Oracle9i database and the Partitioning option is enabled, Oracle strongly recommends that you manually analyze three specific tables in the database on a regular basis:

- MGMT_METRICS_RAW
- MGMT_METRICS_1HOUR
- MGMT_METRICS_1DAY

This requirement does not apply to Oracle Database 10g. To determine if Partitioning is available in your Oracle9i database, connect to the database using SQL*Plus and enter the following query:

```
SQL> SELECT VALUE FROM V$OPTION WHERE PARAMETER='Partitioning';
```

If the query returns "TRUE," then partitioning is enabled in the database and you should use the following guidelines when deciding when to analyze these tables:

- The analysis should be done after the number of targets in the EM has after you stabilized.

For example, after you first install the Grid Control, there will be a period of time when you are actively adding new targets to manage. After you have deployed the Oracle Enterprise Manager 10g Grid Control Framework, and after you have added most of the targets that you plan to manage, you should perform the table analysis.

- Thereafter, you should perform the analysis of the tables each time a large number of targets is added to the Grid Control installation.

The statistics generated by the analysis should stay valid as long as the number of targets and collections for the targets stays the same. In other words, the manual analysis should be required only when the number of targets managed changes significantly.

Before analyzing the tables, you must stop the Enterprise Manager rollup DBMS job. You can restart the rollup job after the table analysis has completed. If the rollup job is allowed to run during the analysis, the rollup job will cause the analysis to fail by invalidating all the SQL cursors used in the analysis.

[Example 6-1](#) shows a SQL*Plus session that demonstrates how to stop and restart the rollup job and perform the analysis on the tables.

Example 6-1 Stopping the rollup DBMS Job and Manually Analyzing Selected Management Repository Tables with SQL-Plus

Connected to:

Oracle9i Enterprise Edition Release 9.2.0.4.0 - Production

With the Partitioning, Real Application Clusters, Oracle Label Security, OLAP
and Oracle Data Mining options

JServer Release 9.2.0.4.0 - Production

```
SQL> exec emd_maintenance.remove_em_dbms_jobs;
```

PL/SQL procedure successfully completed.

```
SQL> exec dbms_stats.gather_table_stats('SYSMAN', 'MGMT_METRICS_1DAY', NULL,  
DBMS_STATS.AUTO_SAMPLE_SIZE, FALSE, 'FOR ALL  
COLUMNS', NULL, 'GLOBAL', FALSE, NULL, NULL, NULL);
```

PL/SQL procedure successfully completed.

```
SQL> exec dbms_stats.gather_table_stats('SYSMAN', 'MGMT_METRICS_1HOUR', NULL,  
DBMS_STATS.AUTO_SAMPLE_SIZE, FALSE, 'FOR ALL  
COLUMNS', NULL, 'GLOBAL', FALSE, NULL, NULL, NULL);
```

PL/SQL procedure successfully completed.

```
SQL> exec dbms_stats.gather_table_stats('SYSMAN', 'MGMT_METRICS_RAW', NULL,  
DBMS_STATS.AUTO_SAMPLE_SIZE, FALSE, 'FOR ALL
```



```
COLUMNS' , NULL, ' GLOBAL' , FALSE, NULL, NULL, NULL);
```

PL/SQL procedure successfully completed.

```
SQL> exec emd_maintenance.submit_em_dbms_jobs
```

PL/SQL procedure successfully completed.

6.4 Changing the SYSMAN Password

The SYSMAN account is the default super user account used to set up and administer Enterprise Manager. It is also the database account that owns the objects stored in the Oracle Management Repository. From this account, you can set up additional administrator accounts and set up Enterprise Manager for use in your organization.

The SYSMAN account is created automatically in the Management Repository database during the Enterprise Manager installation. You also provide a password for the SYSMAN account during the installation.

See Also: *Oracle Enterprise Manager Grid Control Installation and Basic Configuration* for information about installing Enterprise Manager

If you later need to change the SYSMAN database account password, you can do so by using the following procedure:

1. Shut down all the Oracle Management Service instances that are associated with the Management Repository.

See Also: ["Controlling the Oracle Management Service"](#) on page 1-16

2. Change directory to the AGENT_HOME/bin directory for the Management Agent that monitors the Management Repository.

To locate the Management Agent that monitors the Management Service, click the **Management Systems** tab in the Grid Control, and note the value of the **Monitoring Agent** field in the General section of the page.

You can also determine the list of targets that are monitored by a particular Oracle Management Agent by navigating to the Oracle Management Agent home page in the Grid Control, or by using the `emctl config agent listtargets` command.

See Also: ["Listing the Targets on a Managed Host"](#) on page 1-23

3. Use the `emctl config agent credentials` command to specify the new password for the OMS and Repository target so the Oracle Management Agent can connect to the Repository.

See Also: ["Specifying New Target Monitoring Credentials"](#) on page 1-22

4. Change the password of the SYSMAN database account using the following SQL*Plus commands:

```
SQL>connect sysman/oldpassword;
SQL>alter user sysman identified by newpassword;
```

- For each Management Service associated with the Management Repository, locate the `emoms.properties` configuration file.

The `emoms.properties` file can be found in the following directory of the Oracle Application Server Home where the Oracle Management Service is installed and deployed:

```
IAS_HOME/sysman/config/
```

- Locate the following entries in the `emoms.properties` file:

```
oracle.sysman.eml.mntr.emdRepPwd=ece067ffc15edc4f
oracle.sysman.eml.mntr.emdRepPwdEncrypted=TRUE
```

- Enter your new password in the first entry and enter `FALSE` in the second entry.

For example:

```
oracle.sysman.eml.mntr.emdRepPwd=new_password
oracle.sysman.eml.mntr.emdRepPwdEncrypted=FALSE
```

- Save and exit the `emoms.properties` file and restart each Management Service associated with the Management Repository.

- After the Oracle Management Service has started, check the contents of the `emoms.properties` file to be sure the password you entered has been encrypted.

For example, the entries should appear as follows:

```
oracle.sysman.eml.mntr.emdRepPwd=ece067ffc15edc4f
oracle.sysman.eml.mntr.emdRepPwdEncrypted=TRUE
```

6.5 Dropping and Recreating the Management Repository

This section provides information about dropping the repository from your existing database and recreating the management repository after you install Enterprise Manager.

6.5.1 Dropping the Management Repository

To recreate the Management Repository, you first remove the Enterprise Manager schema from your repository database. You accomplish this task using the `-action drop` argument to the `RepManager` script, which is described in the following procedure.

To remove the Management Repository from your database:

- Locate the `RepManager` script in the following directory of the Oracle Application Server Home where you have installed and deployed the Oracle Management Service:

```
IAS_HOME/sysman/admin/emdrep/bin
```

- At the command prompt, enter the following command:

```
$PROMPT> RepManager repository_host repository_port repository_SID
-sys_password password_for_sys_account -action drop
```

In this syntax example:

- `repository_host` is the machine name where the repository database is located
- `repository_port` is the repository database listener port address, usually 1521 or 1526
- `repository_SID` is the repository database system identifier
- `password_for_sys_account` is the password of the SYS user for the database. For example, `change_on_install`.
- `-action drop` indicates that you want to drop the repository.

Alternatively, you can use a connect descriptor to identify the database on the RepManager command line. The connect descriptor identifies the host, port, and name of the database using a standard Oracle database syntax.

For example, you can use the connect descriptor as follows to create the Management Repository:

```
$PROMPT> ./RepManager -connect (DESCRIPTION=(ADDRESS=(PROTOCOL=TCP)
(HOST=host1) (PORT=1521)) (CONNECT_DATA=(SERVICE_NAME=service)))
-sys_password efkl34lmm -action drop
```

See Also: "Establishing a Connection and Testing the Network" in the *Oracle Net Services Administrator's Guide* for more information about connecting to a database using connect descriptors

6.5.2 Recreating the Management Repository

The preferred method for creating the Management Repository is to create the repository during the Enterprise Manager installation procedure, which is performed using Oracle Universal Installer.

See Also: *Oracle Enterprise Manager Grid Control Installation and Basic Configuration* for information about installing Enterprise Manager

However, if you need to recreate the repository in an existing database, you can use the RepManager script, which is installed when you install the Oracle Management Service. Refer to the following sections for more information:

- [Using the RepManager Script to Create the Management Repository](#)
- [Using a Connect Descriptor to Identify the Management Repository Database](#)

6.5.2.1 Using the RepManager Script to Create the Management Repository

To create a repository in an existing database:

1. Review the hardware and software requirements for the Management Repository as described in *Oracle Enterprise Manager Grid Control Installation and Basic Configuration*, and review the section "[Management Repository Deployment Guidelines](#)" on page 6-1.
2. Locate the RepManager script in the following directory of the Oracle Management Service home directory:

```
ORACLE_HOME/sysman/admin/emdrep/bin
```

3. At the command prompt, enter the following command:

```
$PROMPT> ./RepManager repository_host repository_port repository_SID
```

```
-sys_password password_for_sys_account -action create
```

In this syntax example:

- *repository_host* is the machine name where the repository database is located
- *repository_port* is the repository database listener port address, usually 1521 or 1526
- *repository_SID* is the repository database system identifier
- *password_for_sys_account* is the password of the SYS user for the database. For example, *change_on_install*.

Enterprise Manager creates the repository in the database you specified in the command line.

6.5.2.2 Using a Connect Descriptor to Identify the Management Repository Database

Alternatively, you can use a connect descriptor to identify the database on the RepManager command line. The connect descriptor identifies the host, port, and name of the database using a standard Oracle database syntax.

For example, you can use the connect descriptor as follows to create the Management Repository:

```
$PROMPT> ./RepManager -connect (DESCRIPTION=(ADDRESS=(PROTOCOL=TCP)
(HOST=host1) (PORT=1521)) (CONNECT_DATA=(SERVICE_NAME=servicename)))
-sys_password efkl34lmm -action create
```

See Also: "Establishing a Connection and Testing the Network" in the *Oracle Net Services Administrator's Guide* for more information about connecting to a database using a connect descriptor

The ability to use a connect string allows you to provide an address list as part of the connection string. The following example shows how you can provide an address list consisting of two listeners as part of the RepManager command line. If a listener on one host becomes unavailable, the second listener can still accept incoming requests:

```
$PROMPT> ./RepManager -connect (DESCRIPTION=
(ADDRESS_LIST=
(ADDRESS=(PROTOCOL=TCP) (HOST=host1) (PORT=1521)
(ADDRESS=(PROTOCOL=TCP) (HOST=host2) (PORT=1521)
(CONNECT_DATE=(SERVICE_NAME=servicename)))
-sys_password efkl34lmm -action create
```

See Also: *Oracle High Availability Architecture and Best Practices*

6.6 Troubleshooting Management Repository Creation Errors

Oracle Universal Installer creates the Management Repository using a configuration step at the end of the installation process. If the repository configuration tool fails, note the exact error messages displayed in the configuration tools window, wait until the other configuration tools have finished, exit from Universal Installer, and then use the following sections to troubleshoot the problem.

6.6.1 "Package Body Does Not Exist" Error While Creating the Repository

If the creation of your Management Repository is interrupted, you may receive the following when you attempt to create or drop the Management Repository at a later time:

```
SQL> ERROR:
ORA-00604: error occurred at recursive SQL level 1
ORA-04068: existing state of packages has been discarded
ORA-04067: not executed, package body "SYSMAN.MGMT_USER" does not exist
ORA-06508: PL/SQL: could not find program unit being called
ORA-06512: at "SYSMAN.SETEMUSERCONTEXT", line 5
ORA-06512: at "SYSMAN.CLEAR_EMCONTEXT_ON_LOGOFF", line 4
ORA-06512: at line 4
```

To fix this problem, see ["General Troubleshooting Techniques for Creating the Repository"](#) on page 6-11.

6.6.2 "Server Connection Hung" Error While Creating the Repository

If you receive an error such as the following when you try to connect to the repository database, you are likely using an unsupported version of the Oracle Database:

```
Server Connection Hung
```

To remedy the problem, upgrade your database to the supported version as described in *Oracle Enterprise Manager Grid Control Installation and Basic Configuration*.

6.6.3 General Troubleshooting Techniques for Creating the Repository

If you encounter an error while creating the Management Repository, drop the repository by running the `-drop` argument to the RepManager script.

See Also: ["Dropping the Management Repository"](#) on page 6-8

If the RepManager script drops the repository successfully, try creating the repository again.

If you encounter errors while dropping the repository, do the following:

1. Connect to the database as SYSDBA using SQL*Plus.
2. Check to see if the SYSMAN database user exists in the repository database.

For example, use the following command to see if the SYSMAN user exists:

```
prompt> SELECT username FROM DBA_USERS WHERE username='SYSMAN';
```

3. If the SYSMAN user exists, drop the user by entering the following SQL*Plus command:

```
prompt> DROP USER SYSMAN CASCADE;
```

4. Check to see if the following triggers exist:

```
SYSMAN.EMD_USER_LOGOFF
SYSMAN.EMD_USER_LOGON
```

For example, use the following command to see if the EMD_USER_LOGOFF trigger exists in the database:

```
prompt> SELECT trigger_name FROM ALL_TRIGGERS
```

```
WHERE trigger_name='EMD_USER_LOGOFF';
```

5. If the triggers exist, drop them from the database using the following commands:

```
prompt> DROP TRIGGER SYSMAN.EMD_USER_LOGOFF;  
prompt> DROP TRIGGER SYSMAN.EMD_USER_LOGON;
```

Reconfiguring the Management Agent and Management Service

This chapter describes how to reconfigure Enterprise Manager if you later revisit your configuration decisions after you have installed the software.

This chapter contains the following sections:

- [Reconfiguring the Oracle Management Agent](#)
- [Reconfiguring the Oracle Management Service](#)

7.1 Reconfiguring the Oracle Management Agent

The following sections describe reconfiguration and tuning changes you can make to the Management Agent after you have installed Enterprise Manager. Refer to the following sections for more information:

- [Configuring the Management Agent to Use a New Management Service](#)
- [Changing the Management Agent Port](#)
- [Controlling the Amount of Disk Space Used by the Management Agent](#)
- [About the Management Agent Watchdog Process](#)
- [Setting the Management Agent Time Zone](#)

7.1.1 Configuring the Management Agent to Use a New Management Service

When you install the Management Agent on a managed host, you associate the Agent with a particular Management Service. The Management Agent uses the Management Service URL address and port to identify and communicate with the Management Service.

After you install the Management Agent, you can later reconfigure the Management Agent so it is associated with a different Management Service. Reconfiguring the Agent requires no changes to the Management Service. The reconfigured Agent will begin communicating with the new Management Service after the Agent is restarted.

To associate the Management Agent with a new Management Service after you have installed the Agent:

1. Stop the Management Agent.

See Also: ["Starting, Stopping, and Checking the Status of the Management Agent on UNIX"](#) on page 1-14

2. Locate the `emd.properties` file in the Agent home directory:
3. Use a text editor to open the file and locate the `REPOSITORY_URL` property.
4. Modify the value for the `REPOSITORY_URL` property so it references the new Management Service.

For example:

```
REPOSITORY_URL=http://mgmthost2.acme.com:4889/em/upload
```

5. Modify the value for the `emdWalletSrcUrl` and `emdWalletDest` properties so they reference the new Management Service and the new Oracle home path, respectively:

For example, if the new Management Service is on a host called `mgmthost2.acme.com` and the new Oracle home is `/private/oracle/em10g`, modify the properties as follows:

```
emdWalletSrcUrl=http://mgmthost2.acme.com:4889/em/wallets/emd
emdWalletDest=/private/oracle/em10g/sysman/config/server
```

6. Save your changes and close the `emd.properties` file.
7. Delete all the files in the following directories:

```
AGENT_HOME/sysman/emd/upload/
AGENT_HOME/sysman/emd/state/
```

8. Restart the Management Agent.

7.1.2 Changing the Management Agent Port

The Oracle Management Agent uses a predefined port number to receive requests from the Management Service. This port number is defined by default when you install the Agent on a managed host. If you later need to modify this port, you can use the following procedure. You might need to modify this port number if you have existing software that uses the default Agent port.

To change the Management Agent port:

1. Stop the Management Agent.

See Also: ["Starting, Stopping, and Checking the Status of the Management Agent on UNIX"](#) on page 1-14

2. Locate the `emd.properties` file in the Agent home directory:
3. Use a text editor to open the file and locate the `EMD_URL` property.

For example:

```
EMD_URL=http://managed_host1.acme.com:1813/emd/main
```

4. Modify the port number in the `EMD_URL` property so the Agent uses a new unused port on the managed host.

For example:

```
EMD_URL=http://managed_host1.acme.com:1913/emd/main
```

5. Start the Management Agent.

7.1.3 Controlling the Amount of Disk Space Used by the Management Agent

Oracle designed the Management Agent to work within a set of disk space limits. These limits prevent the Management Agent from using too much disk space and causing performance or resource issues on your enterprise systems. However, if disk space becomes an issue, you can adjust the default settings that are used to control the amount of disk space used by the Management Agent.

As the Management Agent on a particular host gathers management data about the targets on the host, it saves the collected data on the local disk until the data is uploaded to the Management Repository. The agent saves this collected data and metadata in the following directory:

```
AGENT_HOME/sysman/emd/upload
```

By default, the Management Agent will save up to 50MB of collected data in the upload directory. If the amount of collected data exceeds 50MB, data collection is stopped temporarily until the data is uploaded to the repository and more disk space becomes available.

In addition, the Management Agent checks to be sure that the percentage of disk space currently in use on the local disk does not exceed 98 percent. If this value is exceeded, the Management Agent stops collected data and stops saving information to the Management Agent log and trace files.

You can modify these default settings as follows:

1. Stop the Management Agent.

See Also: ["Starting, Stopping, and Checking the Status of the Management Agent on UNIX"](#) on page 1-14

2. Locate the `emd.properties` file in the Agent home directory:

```
AGENT_HOME/sysman/config/emd.properties
```

3. Use a text editor to open the file and modify the entries shown in [Table 7-1](#).
4. Save your changes and exit the file.
5. Restart the Management Agent.

Table 7-1 Properties for Controlling the Disk Space Used by the Management Agent

Property	Explanation
UploadMaxBytesXML	Use this property in the <code>emd.properties</code> file to specify the maximum number of megabytes (MB) used by the collected data in the Management Agent upload directory. When this limit is exceeded, the Management Agent will stop collecting additional management data until the next upload to the repository reduces the amount of collected data in the upload directory.

Table 7-1 (Cont.) Properties for Controlling the Disk Space Used by the Management

Property	Explanation
UploadMaxDiskUsedPct	<p>Use this property in the <code>emd.properties</code> file to specify the maximum percentage of disk space that can be in use on the local disk before the Management Agent temporarily stops collecting additional data and stops saving information to the Management Agent log and trace files.</p> <p>The Management Agent will begin collecting data again when the percentage of disk space in use falls to less than the percentage specified in the <code>UploadMaxDiskUsedPctFloor</code> property in the <code>emd.properties</code> file.</p>

7.1.4 About the Management Agent Watchdog Process

The Oracle Management Agent is the Enterprise Manager component that gathers the data you need to manage your enterprise efficiently. As a result, Enterprise Manager includes software that keeps track of the Management Agent processes and makes sure the Management Agent stays running.

For example, if the Management Agent quits unexpectedly, this self-monitoring process—referred to as the watchdog process—will restart the Management Agent automatically.

In most situations, the watchdog process works in the background and requires no configuration or maintenance. The watchdog process is controlled by the `emwd` script located in the following directory of the Management Agent home directory:

```
AGENT_HOME/bin/emwd
```

You can identify the watchdog process by using the following command UNIX systems:

```
$PROMPT> ps -ef | grep emwd
```

7.1.5 Setting the Management Agent Time Zone

In today's global economy, it is not uncommon for the systems you manage to reside in multiple locations throughout the world. For example, if your company headquarters are in New Hampshire, USA, you may need to manage systems that reside in California, Canada, and in Europe.

As Enterprise Manager collects monitoring data from Management Agents running on these remote systems, it is important that the data is correlated accurately. A software failure on a machine in Ontario, Canada might be the cause of a performance problem on a machine in Hoboken, New Jersey.

To correlate this data, it is important that Enterprise Manager obtains the correct time zone for each Management Agent that you install. The following sections describe how the Management Agent obtains the time zone and how to correct the problem if the time zone for a Management Agent is incorrect:

- [Understanding How the Management Agent Obtains Time Zone Information](#)
- [Troubleshooting Management Agent Time Zone Problems](#)
- [Troubleshooting Oracle Management Service Time Zone Problems](#)

7.1.5.1 Understanding How the Management Agent Obtains Time Zone Information

When you install the Management Agent, the software attempts to obtain the current time zone of the host computer. If successful, the installation procedure updates the `agentTZRegion` property setting in the following configuration file:

```
AGENT_HOME/sysman/config/emd.properties
```

The `agentTZRegion` property can be set to any of the values listed in the following file, which is installed in the Management Agent home directory:

```
AGENT_HOME/sysman/admin/suportedtzs.lst
```

7.1.5.2 Troubleshooting Management Agent Time Zone Problems

Sometimes, during the Management Agent installation, the time zone detected by the Agent configuration tool is not recognized by the Management Agent. In other words, the time zone obtained by the configuration tool is not listed in the Management Agent list of supported time zones.

This problem prevents the Management Agent from starting and results in the an error similar to the following:

```
Could not determine agent time zone. Please refer to to the file:
ORACLE_HOME/sysman/admin/supportedtzs.lst and pick a timezone region with a
standard offset of +5:0 from GMT and update the property 'agentTZRegion' in the
file: ORACLE_HOME/sysman/config/emd.properties
```

This error appears in one of the log files shown in [Table 7-2](#), depending upon which Enterprise Manager product you are using.

Table 7-2 Location of Time Zone Error in the Enterprise Manager Log Files

If you are using...	Look for the Time Zone Error in This File...
Grid Control	<code>emagent.nohup</code>
Application Server Control	<code>em.nohup</code>
Database Control	<code>emdb.nohup</code>

See Also: ["Locating and Configuring Management Agent Log and Trace Files"](#) on page 5-1 for more information about the Oracle Management Agent log files

To configure the Management Agent to use a valid time zone:

1. Enter the following command in the Management Agent home directory to identify the time zone currently being used by the host computer:

```
AGENT_HOME/bin/emctl config agent getTZ
```

2. Note the time zone that is returned by this `emctl config agent getTZ` command.

This is the time zone of the host computer.

3. Use a to open the following file in the Management Agent home directory:

```
AGENT_HOME/sysman/admin/supportedtzs.lst
```

This file contains a list of all the time zones supported by the Management Agent.

4. Browse the contents of the `supportedtzs.lst` file and note the supported time zone closest to the time zone of the host computer.

5. Use a text editor to open the following Management Agent configuration file:

```
AGENT_HOME/sysman/config/emd.properties
```

6. Locate the following property near the end of the `emd.properties` file:

```
agentTZRegion=
```

7. Set the value of this property to the time zone you identified as closest the host time zone in the `supportedtzs.lst` file.

For example:

```
agentTZRegion=Europe/Warsaw
```

8. Save your changes and close the `emd.properties` file.

You should now be able to start the Management Agent without generating the error in the log file.

7.1.5.3 Troubleshooting Oracle Management Service Time Zone Problems

Section 7.1.5.2 describes how to correct potential problems that result when the Management Agent cannot determine the proper time zone. Similar problems can occur when the Management Agent finds the correct time zone, but the time zone is not recognized by the the Management Service or the database where the Management Repository resides.

When the Management Service does not recognize the time zone established by the Management Agent, Enterprise Manager generates the following error:

```
OMS does not understand the timezone region of the agent.  
Either start the OMS using the extended list of time zones supported by  
the database or pick a value of time zone from  
ORACLE_HOME/emdw/sysman/admin/nsupportedtzs.lst, update the property  
'agentTZRegion' in the file  
ORACLE_HOME/sysman/config/emd.properties and restart the agent.  
A value which is around an offset of -05:00 from GMT should be picked.
```

This error appears in one of the log files shown in Table 7-2, depending upon which Enterprise Manager product you are using.

There are two ways to correct this problem:

- Restart the Management Repository database using the more extensive list of time zones in the `timezlrq.dat` database configuration file, and then start the Management Agent.

See Also: "Specifying the Database Time Zone File" in the *Oracle Database Administrator's Guide*

- Specify a new time zone for the Management Agent that the Management Repository database will recognize.

See Also: "Troubleshooting Management Agent Time Zone Problems" on page 7-5 for instructions on changing the time zone assigned to the Management Agent

7.2 Reconfiguring the Oracle Management Service

The following sections describe configuration changes you can make to the Management Service after you install Enterprise Manager:

- [Configuring the Management Service to Use a New Repository](#)
- [Configuring the Management Service to Use a New Port](#)

7.2.1 Configuring the Management Service to Use a New Repository

When you install and deploy the Management Service, you associate the Management Service with a Management Repository. The Management Service uses the database host, database system identifier (SID), database port, management user, and management password to identify and communicate with the Repository.

This repository information is stored in the `emoms.properties` file, which can be found in the following directory of the Oracle Application Server Home where the Oracle Management Service is installed and deployed:

```
IAS_HOME/sysman/config/
```

The following sections describe how to modify the repository information in the `emoms.properties` file and provide details about how Enterprise Manager keeps the Management Repository password secure.

7.2.1.1 Changing the Repository Properties in the `emoms.properties` File

To associate the Oracle Management Service with a new repository, you must modify the repository properties saved in the `emoms.properties` configuration file:

1. Stop the Management Service.

See Also: ["Controlling the Oracle Management Service"](#) on page 1-16

2. Locate the `emoms.properties` file in the following directory of the Oracle Application Server Home where you installed and deployed the Management Service:

```
AS_HOME/sysman/config/
```

3. Edit the `emoms.properties` file by updating the appropriate values for the properties described in [Table 7-3](#).

[Example 7-1](#) shows sample entries in the `emoms.properties` file.

4. Restart the Management Service.

Table 7-3 *Repository Properties in the `emoms.properties` File*

Property	Description
<code>emdRepUser</code>	The Management Repository user name. The default value is <code>SYSMAN</code> .
<code>emdRepPwd</code>	The Management Repository password. The default value is <code>sysman</code> , but when you open the file you will notice that the value for this property is an encrypted string. Remove the encrypted string and enter the management password for the new Management Repository.

Table 7-3 (Cont.) Repository Properties in the emoms.properties File

Property	Description
emdRepSID	The System Identifier (SID) for the database where the Management Repository schema resides.
emdRepServer	The name of the server or host computer where the repository database resides.
emdRepPort	The port number for the repository database.
emdRepPwdEncrypted	This property must be set to FALSE so you can manually modify the management password (emdRepPwd) property. For more information, see " About Changing the Repository Password " on page 7-8.

Example 7-1 Sample Repository Properties in the emoms.properties File

```
oracle.sysman.eml.mntr.emdRepUser=SYSMAN
oracle.sysman.eml.mntr.emdRepPwd=sysman
oracle.sysman.eml.mntr.emdRepPwdEncrypted=false
oracle.sysman.eml.mntr.emdRepSID=oemrep1
oracle.sysman.eml.mntr.emdRepServer=system12.mycompany.com
oracle.sysman.eml.mntr.emdRepPort=1521
```

7.2.1.2 About Changing the Repository Password

For security reasons, the password stored in the `emoms.properties` file is encrypted as soon as you start the Management Service. For this reason, when you edit the `emoms.properties` file after the Management Service has been started at least once, you will notice that the `emdRepPwdEncrypted` property is set to TRUE.

As a result, to modify the repository password, you must do the following:

1. Stop the Management Service.
2. Open the `emoms.properties` file.
3. Change the `emdRepPwdEncrypted` property to FALSE.
4. Change the `emdRepPwd` property to the new password.
5. Save the changes and close the `emoms.properties` file.
6. Restart the Management Service.

When the Management Service starts, it opens the `emoms.properties` file, encrypts the password, and changes the `emdRepPwdEncrypted` property to TRUE.

7.2.2 Configuring the Management Service to Use a New Port

When you install the Management Service, the port number for the Management Service is automatically set to 4889. The following procedure describes how to manually change the port number after the Enterprise Manager installation. For example, you will have to modify the port number if you attempt to install two Oracle Management Services on the same host computer.

To change the default Management Service port:

1. Stop the Management Service.

See Also: "[Controlling the Oracle Management Service](#)" on page 1-16

2. Locate the following `httpd_em.conf` file located in the following directory in the Oracle Application Server home directory where you installed and deployed the Management Service:

```
AS_HOME/sysman/config/
```

3. Open the `http_em.conf` file with a text editor and change all occurrences of 4889 to the new port number you want to use.
4. Save and close the `http_em.conf` file.
5. Locate the `emoms.properties` file in the same `sysman/config` directory.
6. Open the `emoms.properties` file with a text editor and change the following entry so it references the new port number of the Management Service:

```
oracle.sysman.emSDK.svlt.ConsoleServerPort=4889
```

7. Restart the Management Service.
8. Reconfigure each Agent on your managed hosts to use the new management port.

See Also: ["Configuring the Management Agent to Use a New Management Service"](#) on page 7-1

Migrating from Previous Versions of Enterprise Manager

This chapter discusses the migration procedure used to move from a previous version of Oracle Enterprise Manager to the new Oracle Enterprise Manager 10g environment. This chapter contains the following topics:

- [Overview of the Enterprise Manager Migration Process](#)
- [Requirements for Migrating from Previous Versions of Enterprise Manager](#)
- [The Oracle Enterprise Manager 10g Migration Process](#)
- [Configuring Metric Thresholds](#)

8.1 Overview of the Enterprise Manager Migration Process

This chapter describes how to migrate from the following versions of Enterprise Manager:

- Oracle Enterprise Manager Release 2.2
- Oracle Enterprise Manager Release 9.0.1
- Oracle Enterprise Manager Release 9.2

Migrating your existing Enterprise Manager framework to the Oracle Enterprise Manager 10g environment involves two steps:

- Making targets within your managed environment monitorable using the new framework by installing Oracle Enterprise Manager 10g Management Agents on hosts that are running your managed targets
- Migrating information about users, privileges, groups, and preferred credentials from the old management repository to the new Oracle Enterprise Manager 10g Management Repository.

Once you have completed migrating to the new framework, you may wish to change the default metric thresholds for groups of managed targets within your enterprise.

See Also: ["Configuring Metric Thresholds"](#) on page 8-8

8.2 Requirements for Migrating from Previous Versions of Enterprise Manager

Before beginning the migration process, ensure that the following list of requirements is satisfied:

- The previous version of complete Enterprise Manager Framework (Release 2.2, 9.0.1, or 9.2) must be up and running, including the Enterprise Manager Console, Oracle Management Server, Repository, and Intelligent Agents. The migration procedure uses the Job system in the previous version of Enterprise Manager to deploy the Oracle Enterprise Manager 10g Management Agents.
- The Oracle Enterprise Manager 10g Grid Control must be installed and running on a network host. Specifically, the Management Service must be up and running and available to the Oracle Enterprise Manager 10g Management Agents that you will install on your managed hosts.
- You must have the credentials for the Enterprise Manager Administrator Account for both the previous version of Enterprise Manager, as well as for Oracle Enterprise Manager 10g. Account read/write privileges are required for any machine currently running the Release 2.2, 9.0.1 or 9.2 Intelligent Agent.
- You must have the Database User and Password for the previous version of the Enterprise Manager Repository Database, as well as for the Oracle Enterprise Manager 10g Management Repository database.
- You must have 375 Megabytes of free disk space on each host where an Management Agent is to be installed.
- You must have installed the latest system and software patches for the Oracle Enterprise Manager 10g environment. Note that the system and software patch requirements for the Oracle Enterprise Manager 10g Grid Control are significantly different from previous versions of Enterprise Manager.

See Also: *Oracle Enterprise Manager Basic Installation and Configuration*

8.3 The Oracle Enterprise Manager 10g Migration Process

Migrating from a previous version of Enterprise Manager to the Oracle Enterprise Manager 10g Grid Control Framework is a two-stage process. The following sections describe each stage in the process:

- [Deploying and Configuring Oracle Enterprise Manager 10g Management Agents](#)
- [Migrating Management Repository Data](#)

8.3.1 Deploying and Configuring Oracle Enterprise Manager 10g Management Agents

Deploying Oracle Enterprise Manager 10g Management Agents on machines running targets managed by an older version of Enterprise Manager makes these targets monitorable via Oracle Enterprise Manager 10g. To simplify and automate Management Agent deployment, a Tcl script is provided that is submitted as a job from an Enterprise Manager Release 2.2, Release 9.0.1, or Release 9.2 Job system. The deployment script (`agentInstallJob.tcl`) can be found in the Oracle Enterprise Manager 10g home directory at the following location:

```
%ORACLE_HOME/sysman/agent_download/agentInstallJob.tcl
```

Deployment of the Oracle Enterprise Manager 10g Management Agent is carried out in two phases:

- [Deploying the Oracle Enterprise Manager 10g Management Agents Using the Release 2.2, Release 9.0.1, or Release 9.2 Job System](#)

- [Configuring the Oracle Enterprise Manager 10g Management Agents for Use with the Oracle Enterprise Manager 10g Job System \(UNIX Systems Only\)](#)

8.3.1.1 Deploying the Oracle Enterprise Manager 10g Management Agents Using the Release 2.2, Release 9.0.1, or Release 9.2 Job System

The `agentInstallJob.tcl` script must be run as a Tcl job from an Enterprise Manager Release 2.2, Release 9.0.1, or Release 9.2 Console. As shown in [Figure 8–1](#), you define the job by choosing a "Node" target type and then selecting the machines on which the Oracle Enterprise Manager 10g Management Agents are to be installed.

Figure 8–1 *Selecting Machines for Management Agent Deployment*

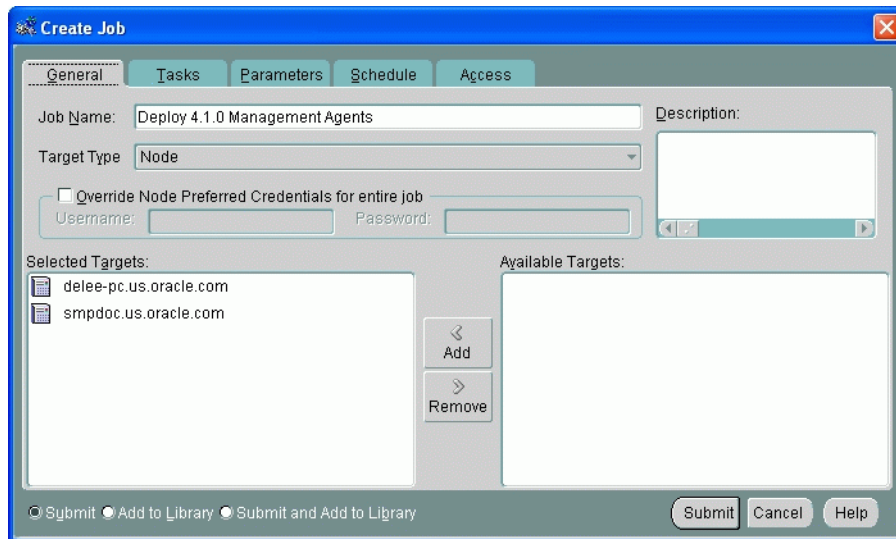

Once you have selected where the Management Agents are to be deployed, you need to define an installation task using `agentInstallJob.tcl`. As shown in [Figure 8–2](#), select the "Run TCL Script" task.

Figure 8–2 *Choosing the Run TCL Script Task*

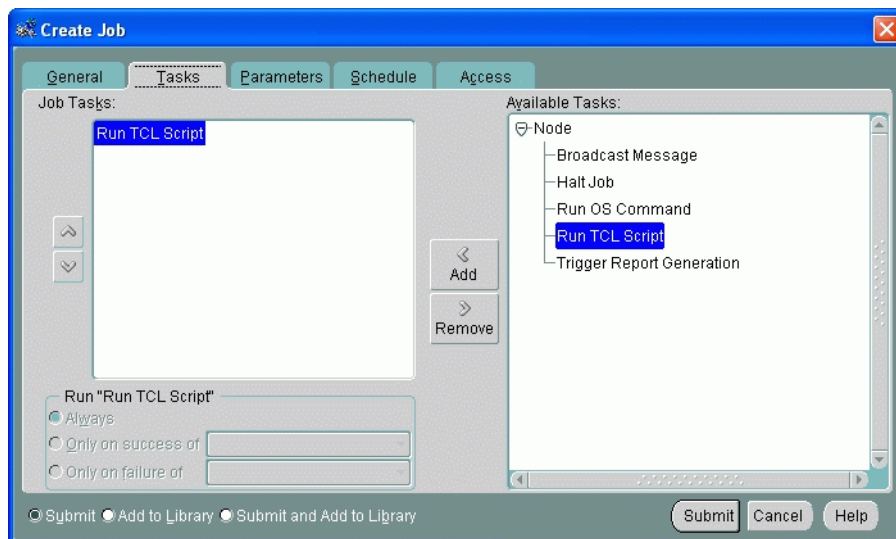

The next step involves defining the functional core of the job. As shown in [Figure 8–3](#), you need to copy the content of the `agentInstallJob.tcl` script into the text entry area using either the Import function or manually copying and pasting the entire script into the TCL Script text entry area.

Figure 8–3 Copying agentInstallJob.tcl and Specifying Job Parameters

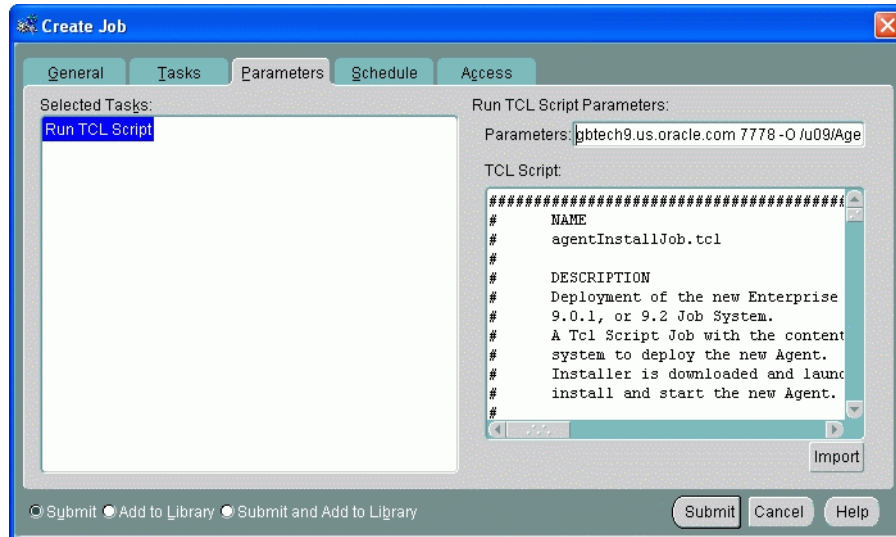

In addition to importing the script content, you must specify operational parameters required by the script to install the Oracle Enterprise Manager 10g Management Agent. As shown in [Figure 8–3](#), you enter these parameters in the **Run TCL Script Parameters** field. The parameters are:

- The Oracle Management Service host
Example: `mgmthost1.acme.com`
- HTTP Port Number
Example: `7778`
- Directory Type (`-o` or `-f`)
Usage:
 - `-o` Identical installation directory structure on all machines.
 - `-f` Different installation directory structure on various machines (specified in text file)
- Directory Argument
Example: `/u09/agent/agent_41`

[Example 8–1](#) and [Example 8–2](#) show the format and syntax used to specify these parameters in the **Run TCL Script Parameters** field.

Example 8–1 Same Installation Directory Structure on All Machines

```
mgmthost1.acme.com 7778 -o /u09/Agent/Agent_41
```

Example 8–2 Different Installation Directory Structure on Different Machines

```
mgmthost1.acme.com 7778 -f hostname_lookup.txt
```

8.3.1.1.1 More About the Directory Type Parameter The Directory Type parameter offers two options either "-o" or "-f" plus the Directory Argument which consists of either a default directory (-o option) or host lookup file (-f option). As mentioned in the previous section, the "-o" option specifies that the same Management Agent home directory structure be created on all machines where the Management Agent is to be installed. For example, if the `agentInstallJob.tcl` job is submitted against MACHINE1, MACHINE2, and MACHINE3 using the following job parameters:

```
mgmthost1.acme.com 7778 -o /u09/agent/agent_41
```

The `agentInstallJob.tcl` script will create the `/u09/agent/agent_41` directory on each of the three machines. Once created, this directory is used by the Oracle Universal Installer (OUI) as an installation staging area. This directory eventually becomes the Oracle Enterprise Manager 10g Management Agent Home.

Note: The `agentInstallJob.tcl` job runs OUI in silent mode to perform the actual Management Agent installation operations.

In contrast, the "-f" option specifies that different installation/Agent Home directory structures be created for specific machines. Before creating a TCL job with this option you must first create a flat text file listing each machine name and corresponding directory for that host. The flat file MUST reside in the Oracle Enterprise Manager 10g Management Service Home in the following directory:

```
%OMS_HOME/sysman/agent_download
```

In the following example, the lookup file parsed by the TCL job is named `hostname_lookup.txt`.

```
mgmthost1.acme.com 7778 -f hostname_lookup.txt
```

When a TCL job is submitted using the "-f" option, the job first obtains the name of the target machine by executing the "hostname" command. The result is then compared against entries in the hostname lookup file. If the hostname is found in the file, the associated directory structure is used. If the hostname is not found, then the directory structure specified for the "wildcard" character is used. The wildcard can be used as a default entry in case the TCL job cannot locate a particular hostname within the file. A wildcard entry is designated by a "*" and must be the last entry as the file is parsed from top to bottom.

[Example 8-3](#) shows the format for a sample hostname lookup file. In the example, you have 20 machines in your enterprise where you want Oracle Enterprise Manager 10g Management Agents installed. You want the same Agent Home directory structure created on all machines except HOST1, HOST2, and HOST3.

Example 8-3 Sample Hostname Lookup File

```
HOST1/oracle_home1/agent/agent_install
HOST2/ora_host2/agent_install
HOST3/orahome_host3/agent/install
*/ora_agent/agent/install
```

The TCL job (submitted to HOST2) runs the hostname command and receives HOST2 as the output. This output is then cross-referenced with all entries within the `hostname_lookup.txt` file. Since HOST2 is an entry in the `hostname_lookup.txt` file, the TCL job knows to create the Oracle Enterprise Manager 10g Management Agent Home in `/ora_host2/agent_install`. HOST1, HOST2, and HOST3 will have unique

directories. The Management Agent home directory for the remaining 17 machines will be `/ora_agent/agent/install`.

Because the TCL job, or more specifically OUI, creates files and directories on the target machines, full read/write privileges for the Enterprise Manager administrator account running the job are required. When the installation is complete the new Oracle Enterprise Manager 10g Management Agent is started automatically and begins retrieving host, database, and listener information. This information is then uploaded via HTTP or HTTPS to the new Enterprise Manager 10g management repository where it becomes available to the Grid Control for viewing.

8.3.1.2 Configuring the Oracle Enterprise Manager 10g Management Agents for Use with the Oracle Enterprise Manager 10g Job System (UNIX Systems Only)

Once the Oracle Enterprise Manager 10g Management Agents are operational, you need to configure each Management Agent for use with the new Oracle Enterprise Manager 10g job system. This step consists of running the `root.sh` script on each machine where the Management Agent is installed. This script is located in the Management Agent Home of the host machine. Specifically, the `root.sh` script grants root privileges to the Oracle Enterprise Manager 10g Management Agent. Therefore, the root user and password for that machine are required in order to run `root.sh`.

As with the `agentInstallJob.tcl` script you can automate this task by running the `root.sh` script using the Enterprise Manager Release 2.2, Release 9.0.1, or Release 9.2 Job system. To do this, you create an "OS command" job that executes "`root.sh`" on all machines requiring Management Agent configuration. As shown in the [Figure 8-4](#), preferred credentials should be overridden by the root user and password of the target host.

Note: The Preferred Credential Override is available with Enterprise Manager Release 9.2 systems only. For older versions of Enterprise Manager, you must run the job as a user with preferred credentials allowing root access.

Figure 8-4 *Overriding Preferred Credentials*

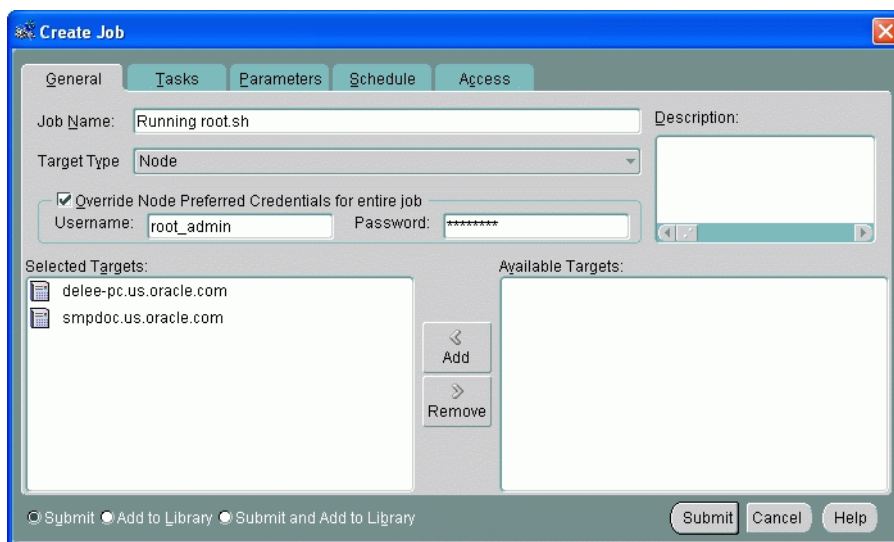

On the job Parameters page (Figure 8-5), specify "root.sh" in the **Command** field as shown in the following figure and submit the job for execution. You must specify the full path to the root.sh script. For example: /u09/agent/agent_41/root.sh

Figure 8-5 Command Parameters

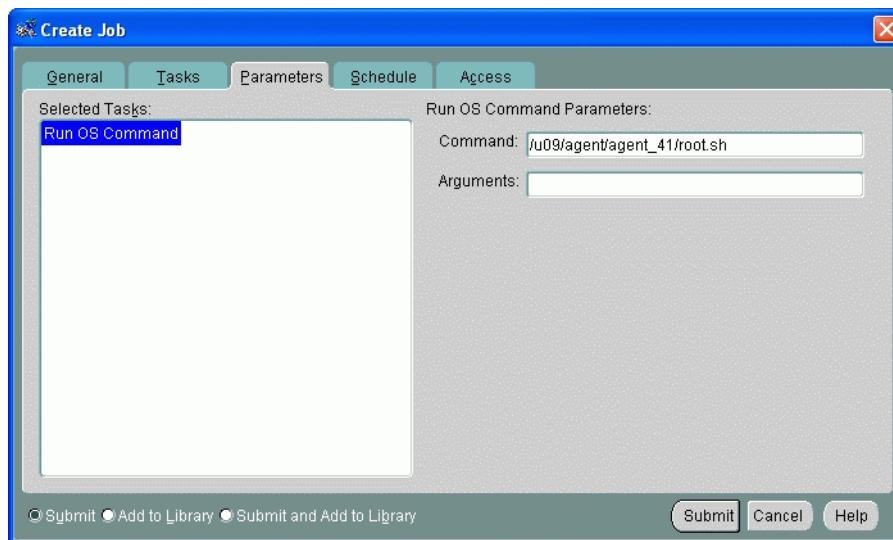

The Oracle Enterprise Manager 10g Management Agent can be up and running when root.sh is executed and does not need to be restarted after the configuration process has been completed.

Note: In previous releases of Enterprise Manager, job system configuration was part of the Intelligent Agent install. With the Enterprise Manager 10g release, this configuration is now a separate step due to architectural differences between the old and new frameworks.

8.3.2 Migrating Management Repository Data

Once the Oracle Enterprise Manager 10g Management Agents have been deployed and configured, the next step is to migrate information about users, privileges, groups, and preferred credentials from the original Management Repository to the Oracle Enterprise Manager 10g Management Repository.

Note: Privileges, group membership, and preferred credentials are migrated for databases, listeners, and hosts only.

Both Enterprise Manager 9i and Oracle Enterprise Manager 10g save and encrypt all administrator accounts and preferred credentials in the repository. In order to migrate all of these accounts over to Enterprise Manager 10g, you must run the Migration Utility from the Enterprise Manager 10g home. This command line utility can be found in the following directory:

```
%EM_HOME%\bin\repo_mig
```

The Migration Utility requires the repository user and password for both the original Management Repository database and for the new Oracle Enterprise Manager 10g

Management Repository database. You execute the utility and specify operational parameters using the following format:

```
repo_mig -preview|-migrate source_user/source_pwd@source_service dest_user/dest_pwd@dest_service
```

where:

- `-preview`: Generates a preliminary migration report without carrying out the migration.
- `-migrate`: Performs migration of groups, administrators, target privileges, and preferred credentials of hosts, databases, and listeners.
- `source_user`: Source OEM repository user name
- `source_pwd`: Source OEM repository password
- `source_service`: Source OEM repository service. For example, Host:Port:SID
- `dest_user`: Destination OEM repository user name
- `dest_pwd`: Destination OEM repository password
- `dest_service`: Destination OEM repository service. (Host:Port:SID)

Once the migration is complete, the account information is then saved and encrypted. The passwords on all of the accounts will remain the same.

8.4 Configuring Metric Thresholds

As mentioned previously, migration only involves transferring users, privileges, groups, and preferred credentials to the Enterprise Manager 10g framework; any event test thresholds that existed in your previous version of Enterprise Manager will not be transferred.

Enterprise Manger 10g provides out-of-the-box monitoring that simplifies a critical but potentially time-consuming task of setting up monitoring for managed targets. As you add targets to Enterprise Manager, options are automatically provided to monitor the target at a recommended or at a minimum level. Each level of monitoring consists of a set of metrics and predefined thresholds that are based on Oracle recommendations for those levels. You may choose to use these Oracle recommendations, or you can change these thresholds to suit your particular needs.

See Also: The Enterprise Manager online help for specific information on modifying metric thresholds

8.4.1 Copying Metric Thresholds to Multiple Targets

Your Enterprise Manager 10g installation may be monitoring a very large number of targets, making it inconvenient to manually change metric threshold values for each monitored target. Enterprise Manager 10g provides an easy way to copy metric thresholds from one target to any number of targets as long as they are the same target type: You simply set new metric thresholds for a single target and then have Enterprise Manager propagate these settings to all other targets of the same type.

To copy metric thresholds, select the Manage Metrics link (located in the Related Links section) from any target home page that offers this capability and follow the instructions given on the web page. For more information about metric threshold settings, see Enterprise Manager 10g online help.

Configuring Notifications

The notification system can, in addition to notifying administrators, automate responses to alerts by executing operating system commands (including scripts) and PL/SQL procedures. This capability allows you to implement specific IT practices in response to specific alerts. For example, if an alert is generated when monitoring the operational (up/down) status of a database, you may want the notification system to automatically open an in-house trouble-ticket using an OS script so that the appropriate IT staff can respond in a timely manner.

By using Simple Network Management Protocol (SNMP) traps, the Enterprise Manager notification system also allows you to access SNMP-enabled third-party applications such as HP OpenView. Some administrators may want to send third-party applications a notification when a certain metric has exceeded a threshold.

Specifically, this chapter contains the following sections:

- [Setting Up Notifications](#)
- [Managing Notification Methods](#)
- [Notification Rules](#)
- [Default Notification Rules](#)
- [Creating Your Own Notification Rules](#)
- [Getting Email Notifications](#)
- [Configuring Methods for Rules](#)
- [Assigning Methods to Rules](#)
- [Assigning Rules to Methods](#)
- [Management Information Base \(MIB\)](#)

9.1 Setting Up Notifications

Notifications are configured using Notification Methods and Notification Rules.

- Notification Methods are the mechanisms by which alerts are sent. Enterprise Manager superusers can setup e-mail notifications by configuring the 'e-mail' notification method. Most likely this would already have been setup as part of the Oracle Management Service installation.

Enterprise Manager superusers can also define other custom notification methods. For example, alerts may need to be forwarded to a 3rd party trouble-ticketing system. Assuming APIs to the third-party trouble-ticketing system are available, a custom notification method can be created to call a custom OS script that has the

appropriate APIs. The custom notification method can be named in a user-friendly fashion, for example, "Log trouble ticket". Once that's defined, any time an administrator needs to send alerts to the trouble-ticketing system, he merely needs to invoke the now globally available notification method called "Log trouble ticket".

Custom notification methods can be defined based on any custom OS script, any custom PL/SQL procedure, or by sending SNMP traps.

- A notification rule is a user-defined rule that instructs Enterprise Manager on how alerts should be sent. Specifically, in each rule, you can specify the alert conditions you're interested in and the notification methods that should be used for sending these alerts. For example, you can set up a rule such that when any database goes down, e-mail should be sent and the "log trouble ticket" notification method should be called. Or you can define another rule such that when the CPU or Memory Utilization of any host reach critical severities, SNMP traps should be sent to another management console. During notification rule creation, you specify the targets you are interested in, their monitored metrics and severity conditions (clear, warning, critical), and the associated notification method.

9.2 Managing Notification Methods

Notification Methods allow you to define different mechanisms for sending notifications. These include e-mail, SNMP traps, or running custom scripts, or all three. Once defined, these methods can then be used with Notification Rules for sending notifications to administrators as a result of alert occurrences.

Through the Notification Methods page, you can:

- Set up the outgoing mail servers if you plan to send e-mail notifications through notification rules
- Create other custom notification methods using OS and PL/SQL scripts and SNMP traps.

9.2.1 Setting Up a Mail Server for Notifications

Before Enterprise Manager can send e-mail notifications using Notification Rules, you must first set up the Outgoing Mail (SMTP) servers using the Notification Methods page (Figure 9-1). Display the Notification Methods page by clicking **Setup** on any page in the **Grid Control** and clicking **Notification Methods** in the vertical navigation bar. Only privileged users can configure SMTP servers.

Specify one or more outgoing mail (SMTP) server names, the name you want to appear as the sender of the notification messages, and the e-mail address you want to use to send your e-mail notifications. This address, called the Sender's Mail Address, must be a valid address on each mail server that you specify. This e-mail address will be notified by the mail server of any problem encountered during the sending of an e-mail notification. See Example 9-1.

Example 9-1 Mail Server Settings

```
Outgoing Mail (SMTP Server) smtp01.oracle.com, smtp02.oracle.com
Identify Sender As Enterprise Manager Notifications
Sender's Mail Address mgmt_rep@oracle.com
```

Figure 9–1 Defining a Mail Server

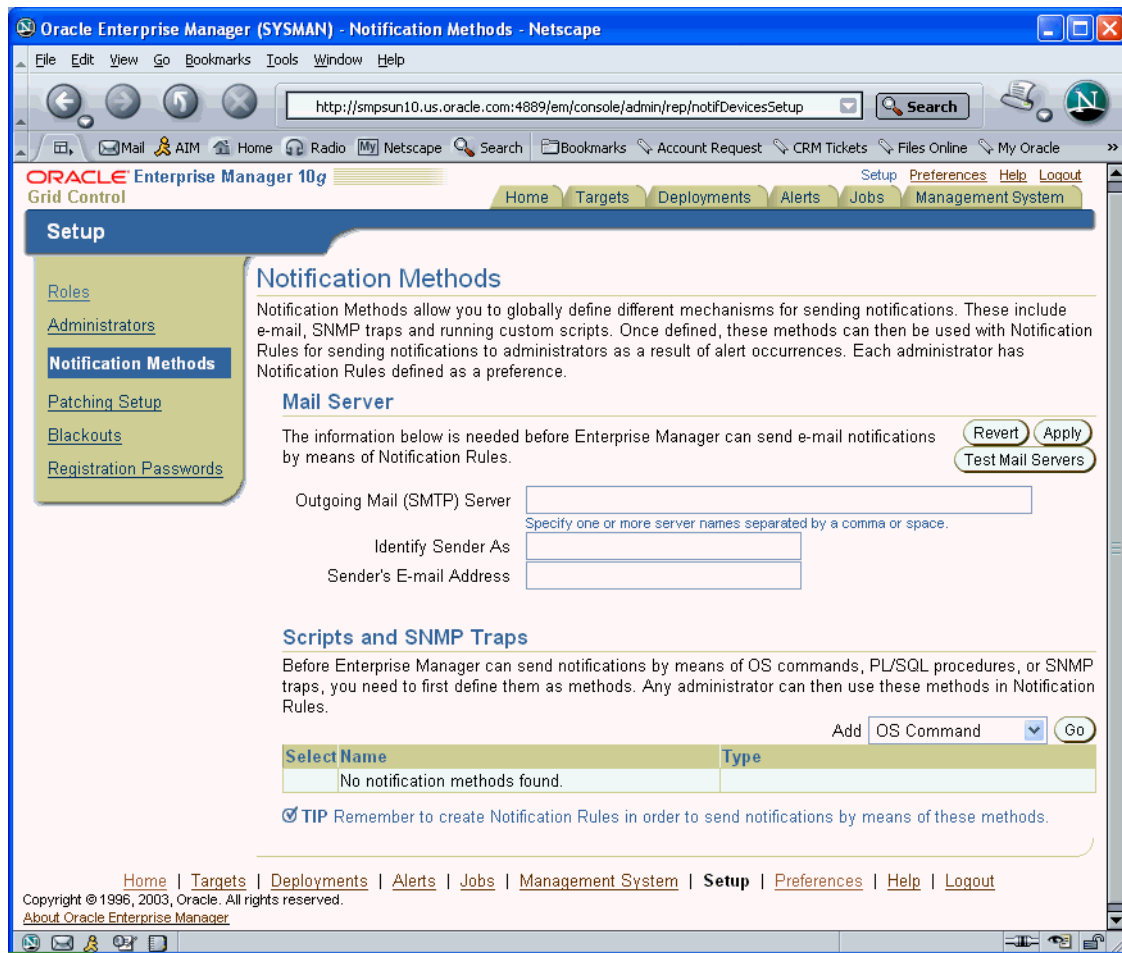

Note: The e-mail address you specify on this page is not the e-mail address to which the notification is sent. You will have to specify the e-mail address (where notifications will be sent) from the Preferences General page. For information on specifying e-mail addresses for e-mail notification, see *Specifying E-mail address for E-mail Notifications*.

After configuring the e-mail server, click **Test Mail Servers** to verify your e-mail setup. You should verify that an e-mail message was received by the e-mail account specified in the **Sender's E-mail Address** field.

Defining multiple mail servers will improve the reliability of e-mail notification delivery and spread the load across multiple systems. The Management Service makes use of each mail server to send e-mails and the behavior is controlled by the following parameters found in the \$ORACLE_HOME/sysman/config/emoms.properties file.

Example 9–2 Management Service Parameters

```
# The maximum number of emails that can be sent in a single connection to an
# email server
em.notification.emails_per_connection=20
#
# The maximum number of emails that can be sent in a minute
```

```
# em.notification.emails_per_minute=250
```

Based on the defaults in [Example 9-2](#), the first mail server is used to send 20 e-mails before the Management Service switches to the next mail server which is used to send another 20 e-mails before switching to the next mail server. This prevents one mail server from becoming overloaded and should improve overall reliability and throughput.

9.2.2 Custom Notification Methods using Scripts and SNMP Traps

You can create other custom notification methods based on OS scripts, PL/SQL procedures, or SNMP traps. Any administrator can then use these methods in Notification Rules.

9.2.2.1 Adding a Notification Method based on an OS Command

You can specify an Operating System command or script that will be called in Notification Rules. The OS Command is run as the user who started the Management Service. The OS command (or script) must exist and be placed on each Management Service host machine that connects to the Management Repository.

Note: Notification methods based on OS commands must be configured by an administrator with superuser privileges before users can choose to select one or more of these OS command methods while creating/editing a notification rule.

The following information is required for each OS command notification method:

- Name
- Description

Both Name and Description should be clear and intuitive so that the function of the method is clear to other administrators.

- OS Command

You must enter the full path of the OS command or script in the OS command field (for example, `/u1/bin/myscript.sh`). For environments with multiple Management Services, the path must be exactly the same on each machine that has a Management Service. Command line parameters can be included after the full path (for example, `/u1/bin/myscript.sh arg1 arg2`).

To define a notification method based on an OS command, perform the following steps.

1. Create an OS command on the repository host machine.

Create an OS Command on each Management Service machine that connects to the Management Repository. The OS Command should be an absolute path name and must be the same on each Management Service host machine, for example, `/u1/bin/logSeverity.sh`. The command is run by the user who started the Management Service. If an error is encountered during the running of the OS Command, the Notification System can be instructed to retry the sending of the notification to the OS Command by returning an exit code of 100. The procedure is initially retried after one minute, then two minutes, then three minutes and so on, until the notification is a day old, at which point it will be purged.

[Example 9-3](#) shows the parameter in `emoms.properties` that controls how long the OS Command can execute without being killed by the Management Service. This is to prevent OS Commands from running for an inordinate length of time and blocking the delivery of other notifications. By default the command is allowed to run for 30 seconds before it is killed.

Example 9-3 Parameter in `emoms.properties` File

```
# The amount of time in seconds after which an OS Command started by the
# Notification System will be killed if it has not exited
# em.notification.os_cmd_timeout=30
```

2. Add this OS command as a notification method that can be called in Notification Rules. See ["Adding a Notification Method based on an OS Command"](#) on page 9-4.
3. Define a notification rule (choose the targets and conditions for which you want to be notified), and associate the OS command with the rule. See ["Creating Your Own Notification Rules"](#) on page 9-17.

[Example 9-4](#) shows an example of the required information.

Example 9-4 OS Command Notification Method

```
Name Trouble Ticketing
Description Notification method to log trouble ticket for a severity occurrence
OS Command /private/mozart/bin/logTicket.sh
```

Note: There can be more than one OS Command configured per system.

Information about the metrics in alert can be made available to your OS notification method. See ["Passing Metric Severity Information"](#) on page 9-8 for more details.

9.2.2.2 Adding a Notification Method Based on a PL/SQL Procedure

Before setting up the method, the procedure must be created on the repository database. Using the database account of the repository owner (such as SYSMAN).

The procedure must have the following signature:

```
PROCEDURE p(severity IN MGMT_NOTIFY_SEVERITY)
```

Note: The notification method based on a PL/SQL procedure must be configured by an administrator with superuser privileges before a user can select it while creating/editing a notification rule.

Information about the metrics in alert can be made available to your PL/SQL procedure. See ["Passing Metric Severity Information"](#) on page 9-8 for more details.

Next, create a notification method based on your PL/SQL procedure. The following information is required when defining the method:

- Name
- Description
- PLSQL Procedure

You must enter a fully qualified procedure name (for example, OWNER.PKGNAME.PROCNAME) and ensure that the owner of the Management Repository has execute privilege on the procedure.

To define a notification method based on a PL/SQL procedure, perform the following steps.

1. Create the PL/SQL procedure on the repository database using the following procedure specification:

```
PROCEDURE p(severity IN MGMT_NOTIFY_SEVERITY)
```

If an error is encountered during the running of the procedure, the Notification System can be instructed to retry the sending of the notification to the procedure by raising a user defined exception that uses the error code -20000. See the example above. The procedure initially retried after one minute, then two minutes, then three minutes and so on, until the notification is a day old, at which point it will be purged.

2. Add this PLSQL procedure as a notification method that can be called in Notification Rules. See "[Adding a Notification Method Based on a PL/SQL Procedure](#)" on page 9-5.

Make sure to use a fully qualified name that includes the schema owner, package name and procedure name. The procedure will be executed by the repository owner and so the repository owner must have execute permission on the procedure.

3. Associate the PL/SQL procedure with a notification rule.

An example of the required information is shown in [Example 9-5](#).

Example 9-5 PL/SQL Procedure Required Information

Name	Cleanup error log
Description	Notification method to clean up the error log table
PLSQL Procedure	mgmt_rep.log_util.cleanup_log

There can be more than one PL/SQL-based method configured per system.

For information about the severity types that relate to a target's availability, and how metric severity information is passed to the PLSQL procedure, see "[Passing Metric Severity Information](#)" on page 9-8 for more details.

9.2.2.3 Adding a Notification Method Based on an SNMP Trap

Enterprise Manager supports integration with third-party management tools through the SNMP. For example, you can use SNMP to notify a third-party application that a selected metric has exceeded its threshold.

The trap is an SNMP Version 1 trap and is described by the MIB definition shown at the end of this chapter. See "[Management Information Base \(MIB\)](#)" on page 9-21.

For more comprehensive configuration information, see the documentation specific to your platform; SNMP configuration differs from platform to platform.

Note: Notification methods based on SNMP traps must be configured by an administrator with superuser privileges before any user can then choose to select one or more of these SNMP trap methods while creating/editing a notification rule.

You must provide the name of the host (machine) on which the SNMP master agent is running and other details as shown in the following example. In [Example 9-6](#), the SNMP host will receive your SNMP traps.

Example 9-6 SNMP Trap Required Information

```
Name HP OpenView Console
Description Notification method to send trap to HP OpenView console
SNMP Trap Host Name machine1.us.oracle.com
SNMP Host Port 162
SNMP Community public
This SNMP host will receive your SNMP traps.
```

Note: A Test Trap button exists for you to test your setup.

Metric severity information will be passed as a one-line message in the SNMP trap.

An example SNMP Trap is shown in [Example 9-7](#). All information is in one line which is sent as a variable embedded in the SNMP Trap.

Example 9-7 SNMP Trap

```
Tue Oct 28 05:00:02 2003

Command: 4
  Enterprise: 1.3.6.1.4.1.111.15.2
  Agent: 138.1.6.200
  Generic Trap: 6
  Specific Trap: 1
  Time Stamp: 8464:39.99
  Count: 11

Name: 1.3.6.1.4.1.111.15.1.1.1.2.1
  Kind: OctetString
  Value: "mydatabase"

Name: 1.3.6.1.4.1.111.15.1.1.1.3.1
  Kind: OctetString
  Value: "Database"

Name: 1.3.6.1.4.1.111.15.1.1.1.4.1
  Kind: OctetString
  Value: "myhost.com"

Name: 1.3.6.1.4.1.111.15.1.1.1.5.1
  Kind: OctetString
  Value: "Owner's Invalid Object Count"

Name: 1.3.6.1.4.1.111.15.1.1.1.6.1
  Kind: OctetString
  Value: "Invalid Object Owner"

Name: 1.3.6.1.4.1.111.15.1.1.1.7.1
  Kind: OctetString
  Value: "SYS"

Name: 1.3.6.1.4.1.111.15.1.1.1.8.1
  Kind: OctetString
  Value: "28-OCT-2003 04:59:10 (US/Eastern GMT) "
```

```

Name: 1.3.6.1.4.1.111.15.1.1.1.9.1
  Kind: OctetString
  Value: "Warning"

Name: 1.3.6.1.4.1.111.15.1.1.1.10.1
  Kind: OctetString
  Value: "12 object(s) are invalid in the SYS schema."

Name: 1.3.6.1.4.1.111.15.1.1.1.11.1
  Kind: OctetString
  Value: "Database Metrics"

Name: 1.3.6.1.4.1.111.15.1.1.1.12.1
  Kind: OctetString
  Value: "SYSMAN"

```

9.2.3 Passing Metric Severity Information

Passing metric severity attributes (severity level, type, notification rule, rule owner, or rule owner, and so on) to PL/SQL procedures or OS commands/scripts allows you to customize automated responses to alerts. For example, if an OS script opens a trouble ticket for an in-house support trouble ticket system, you will want to pass severity levels (critical, warning, and so on) to the script to open a trouble ticket with the appropriate details and escalate the problem.

9.2.3.1 Passing Information to an OS Script or Executable

The notification system passes severity information to an OS script or executable using system environment variables. Conventions used to access environmental variables vary depending on the operating system:

- UNIX: \$ENV_VARIABLE
- Windows: %ENV_VARIABLE%

The notification system sets the following environment variables before calling the script. The script can then use any or all of these variables within the logic of the script.

Table 9–1 Environment Variables

Environment Variable	Description
TARGET_NAME	Name of the target on which the severity occurred.
TARGET_TYPE	Type of target on which the severity occurred. Targets are defined as any monitorable service.
HOST	Name of the machine on which the target resides.
METRIC	Metric generating the severity.
KEY_VALUE	For metrics that monitor a set of objects, the KEY_VALUE indicates the specific object that triggered the severity. For example for the Tablespace Space Used (%) metric that monitors tablespace objects, the KEY_VALUE is 'USERS' if the USERS tablespace triggered at warning or critical severity.
KEY_VALUE_NAME	For metrics that monitor a set of objects, the KEY_VALUE_NAME indicates the type of object monitored. For example for the Tablespace Space Used (%) metric that monitors tablespace objects, the KEY_VALUE_NAME is 'Tablespace Name'.
TIMESTAMP	Time when the severity occurred.

Table 9–1 (Cont.) Environment Variables

Environment Variable	Description
SEVERITY	Type of severity. For example, severity types that relate to a target's availability are: <ul style="list-style-type: none"> ▪ UP ▪ DOWN ▪ UNREACHABLE CLEAR ▪ UNREACHABLE START ▪ BLACKOUT END ▪ BLACKOUT START Other metrics can have any of the following severities: <ul style="list-style-type: none"> ▪ WARNING ▪ CRITICAL ▪ CLEAR ▪ METRIC ERROR CLEAR ▪ METRIC ERROR START
MESSAGE	Message for the alert that provides details about what triggered the condition.
RULE_NAME	Name of the notification rule that resulted in the severity.
RULE_OWNER	Name of the Enterprise Manager administrator who owns the rule.

Your script may reference some or all of these variables.

[Example 9–8](#) shows an OS command script appending environment variable entries to a log file.

[Example 9–8](#) logs a severity occurrence to a file server. If the file server is unreachable then an exit code of 100 is returned to force the Oracle Management Service Notification System to retry the notification

Example 9–8 Sample OS Command Script

```
#!/bin/ksh

LOG_FILE=/net/myhost/logs/severity.log
if test -f $LOG_FILE
then
echo $TARGET_NAME $MESSAGE $TIMESTAMP >> $LOG_FILE
else
    exit 100
fi
```

[Example 9–9](#) shows an OS script that logs alert information to the file 'alertmsg.txt'. The file is saved to the /u1/results directory.

Example 9–9 Alert Logging Script

```
#!/usr/bin/sh
echo "Alert logged:" > /u1/results/alertmsg.txt
echo "\n" >> /u1/results/alertmsg.txt
echo "target name is " $TARGET_NAME >> /u1/results/alertmsg.txt
echo "target type is " $TARGET_TYPE >> /u1/results/alertmsg.txt
```

```

echo "target is on host " $HOST >> /u1/results/alertmsg.txt
echo "metric in alert is " $METRIC >> /u1/results/alertmsg.txt
echo "metric index is " $KEY_VALUE >> /u1/results/alertmsg.txt
echo "timestamp is " $TIMESTAMP >> /u1/results/alertmsg.txt
echo "severity is " $SEVERITY >> /u1/results/alertmsg.txt
echo "message is " $MESSAGE >> /u1/results/alertmsg.txt
echo "notification rule is " $RULE_NAME >> /u1/results/alertmsg.txt
echo "rule owner is " $RULE_OWNER >> /u1/results/alertmsg.txt
exit 0

```

Example 9–10 shows a script that sends an alert to an HP OpenView console from Enterprise Manager Grid Control. When a metric alert is triggered, the Enterprise Manager Grid Control displays the alert. The HP OpenView script is then called, invoking `opcmsg` and forwarding the information to the HP OpenView management server.

Example 9–10 HP OpenView Script

```

/opt/OV/bin/OpC/opcmsg severity="$SEVERITY" app=OEM msg_grp=Oracle msg_
text="$MESSAGE" object="$TARGET"

```

9.2.3.2 Passing Information to a PL/SQL Procedure

The notification system passes severity information to a PL/SQL procedure using the `MGMT_NOTIFY_SEVERITY` object. An instance of this object is created for every alert. When an alert occurs, the notification system calls the PL/SQL procedure associated with the notification rule and passes the populated object to the procedure. The procedure is then able to access the fields of the `MGMT_NOTIFY_SEVERITY` object that has been passed to it.

Table 9–2 lists all metric severity attributes that can be passed:

Table 9–2 Metric Severity Attributes

Attribute	Datatype	Additional Information
target_name	VARCHAR2(64)	Name of the target on which the severity occurred.
target_type	VARCHAR2(64)	Type of target on which the severity occurred. Targets are defined as any monitorable service.
timezone	VARCHAR2(64)	The target’s regional timezone
host_name	VARCHAR2(128)	Name of the machine on which the target resides.
metric_name	VARCHAR2(64)	Metric generating the severity.
metric_description	VARCHAR2(128)	Meaningful description of the metric that can be understood by other administrators.
metric_column	VARCHAR2(64)	For table metrics, the metric column contains the name of the column in the table that is being defined. If the metric that is being defined is not a table metric, the value in this column is a single space.

Table 9–2 (Cont.) Metric Severity Attributes

Attribute	Datatype	Additional Information
key_value	VARCHAR2(256)	For metrics that monitor a set of objects, the KEY_VALUE indicates the specific object that triggered the severity. For example for the Tablespace Space Used (%) metric that monitors tablespace objects, the KEY_VALUE is 'USERS' if the USERS tablespace triggered at warning or critical severity.
key_value_name	VARCHAR2(512)	For metrics that monitor a set of objects, the KEY_VALUE_NAME indicates the type of object monitored. For example for the Tablespace Space Used (%) metric that monitors tablespace objects, the KEY_VALUE_NAME is 'Tablespace Name'.
key_value_guid	VARCHAR2(256)	GUID associated with a composite key value name.
collection_timestamp	DATE	The time when the target status change was last detected and logged in the management repository.
severity_code	NUMBER	Numeric code identifying the severity level. See Severity Code table below.
message	VARCHAR2(4000)	An optional message that is generated when the alert is created that provides additional information about the alert condition.
severity_guid	RAW(16)	Severity global unique identifier.
metric_guid	RAW(16)	Metric global unique identifier.
target_guid	RAW(16)	Target global unique identifier.
rule_owner	VARCHAR2(64)	Name of the Enterprise Manager administrator who owns the rule.
rule_name	VARCHAR2(132)	Name of the notification rule that resulted in the severity.

When a severity occurs for the target, the notification system creates an instance of the MGMT_NOTIFY_SEVERITY object and populates it with values from the severity. The severity codes in [Table 9–3](#) have been defined as constants in the MGMT_GLOBAL package and can be used to determine the type of severity in the severity_code field of the MGMT_NOTIFY_SEVERITY object. See [Example 9–11](#).

Table 9–3 Severity Codes

Name	Datatype	Value
G_SEVERITY_COMMENT	NUMBER(2)	10
G_SEVERITY_CLEAR	NUMBER(2)	15
G_SEVERITY_WARNING	NUMBER(2)	20
G_SEVERITY_CRITICAL	NUMBER(2)	25
G_SEVERITY_UNREACHABLE_CLEAR	NUMBER(3)	115
G_SEVERITY_UNREACHABLE_START	NUMBER(3)	125
G_SEVERITY_BLACKout_END	NUMBER(3)	215
G_SEVERITY_BLACKout_START	NUMBER(3)	225

Table 9–3 (Cont.) Severity Codes

Name	Datatype	Value
G_SEVERITY_ERROR_END	NUMBER(3)	315
G_SEVERITY_ERROR_START	NUMBER(3)	325
G_SEVERITY_NO_BEACONS	NUMBER(3)	425
G_SEVERITY_UNKNOWN	NUMBER(3)	515

Example 9–11 PL/SQL Procedure Using a Severity Code

```

CREATE TABLE alert_log (target_name VARCHAR2(64),
alert_msg VARCHAR2(4000),
occured DATE);

PROCEDURE LOG_CRITICAL_ALERTS(severity IN MGMT_NOTIFY_SEVERITY)
IS
BEGIN
-- Log all critical severities
IF severity.severity_code = MGMT_GLOBAL.G_SEVERITY_CRITICAL
THEN
BEGIN
INSERT INTO alert_log (target_name, alert_msg, occured)
VALUES (severity.target_name, severity.message,
severity.collection_timestamp);
EXCEPTION
WHEN OTHERS
THEN
-- If there are any problems then get the notification retried
RAISE_APPLICATION_ERROR(-20000, 'Please retry');
END;
COMMIT;
END IF;
END LOG_CRITICAL_ALERTS;

```

9.3 Notification Rules

Notification rules allow you to choose the targets and conditions for which you want to receive notifications from Enterprise Manager. The methods for sending notifications include e-mail, SNMP traps, or running custom scripts, or all three.

After you set up your notification methods, you can define the rules that Enterprise Manager will use when sending notifications. When you define the notification rules, you can choose to make them 'public' to share them with other administrators, or to keep them 'private' for your own use. When logged into the Enterprise Manager Grid Control, you can see both types of rules:

1. Click the **Preferences** global link.
2. In the Notification section of vertical navigational bar, you can click **My Rules** to access all the rules that you have defined.
3. In the same navigational bar, you can click **Public Rules** to access all rules defined by other administrators that have been made public.

An Administrator with superuser privileges can see all rules (private and public).

9.4 Default Notification Rules

When you installed the Oracle Management Service, you would have been given an option to receive e-mail notifications for critical alerts. If you chose this option, then some default notification rules would have been created that covered the availability and critical states for the more common target types. If an e-mail address for the SYSMAN user was specified, then these rules would also be configured to send e-mail for these conditions.

Table 9–4 lists all the default notification rules. These are all owned by the SYSMAN user and are public rules.

Table 9–4 Default Notification Rules

Name	Description	Target Type	Send Notification on the Following Availability States	Send Notification on the Following Metrics and their CRITICAL and WARNING States
Application Server Availability and Critical/Warning States	System-generated notification rule for monitoring Application Servers' availability, and critical and warning metric statuses.	Application Servers	Down Unreachable Start Unreachable End	Metric Label: CPU Usage (%) Metric Name: ResourceUsage Metric Column: Cpu.component Metric Label: Response Time (seconds) Metric Name: Response Metric Column: Timing.sec
OC4J Availability and Critical/Warning States	System-generated notification rule for monitoring OC4J instance's availability, and critical and warning metric statuses.	OC4J	Down Unreachable Start Unreachable End	Metric Label: CPU Usage (%) Metric Name: ResourceUsage Metric Column: Cpu.components Metric Label: Request Processing Time for the OC4J Instance (seconds) Metric Name: oc4j_instance_rollup Metric Column: processRequest.time Metric Label: Active Sessions for the OC4J Instance Metric Name: oc4j_instance_rollup Metric Column: session.active

Table 9–4 (Cont.) Default Notification Rules

Name	Description	Target Type	Send Notification on the Following Availability States	Send Notification on the Following Metrics and their CRITICAL and WARNING States
HTTP Server Availability and Critical/Warning States	System-generated notification rule for monitoring HTTP Server's availability, and critical and warning metric statuses.	Oracle HTTP Server	Down Unreachable Start Unreachable End	Metric Label: CPU Usage (%) Metric Name: ResourceUsage Metric Column: cpu.component Metric Label: Request Processing Time (seconds) Metric Name: ohs_server Metric Column: request.currentProcessingTime Metric Label: Active HTTP Connections Metric Name: ohs_server Metric Column: connection.active Metric Label: Percentage of Busy Processes Metric Name: ohs_server Metric Column: busyProcesses.currentPercentage
Web Cache Availability and Critical/Warning States	System-generated notification rule for monitoring Web Cache's instance's availability, and critical and warning metric statuses.	Oracle Web Cache	Down Unreachable Start Unreachable End	Metric Label: CPU Usage (%) Metric Name: ResourceUsage Metric Column: cpu.component Metric Label: Hits (% if requests) Metric Name: HIST Metric Column: HIST__COMPUTED__HIT_RATE

Table 9–4 (Cont.) Default Notification Rules

Name	Description	Target Type	Send Notification on the Following Availability States	Send Notification on the Following Metrics and their CRITICAL and WARNING States
Database Availability and Critical/Warning States	System-generated notification rule for monitoring Databases' availability, and critical and warning metric statuses.	Databases (single instance only)	Down Unreachable Start Unreachable End	Metric Name: Alert Log Metric Column: Archiver Hung Metric Name: Alert Log Metric Column: Data Block Corruption Metric Name: User Block Metric Column: Blocking Session Count Metric Name: User Wait Time Metric Column: User Wait Time (%) Metric Name: Database Limits Metric Column: Datafile Usage (%) Metric Name: Database Limits Metric Column: Lock Limit Usage (%) Metric Name: Database Limits Metric Column: Process Limit Usage (%) Metric Name: Database Limits Metric Name: Archive Area Metric Column: Used (%) Metric Column: Session Limit Usage (%) Metric Name: Problem Tablespace Metric Column: Tablespace Space Used (%) Metric Name: Problem Tablespace Metric Column: Segments Unable to Extend Count Metric Name: Problem Tablespace Metric Column: Segments Approaching MaxExtents
Listener Availability	System-generated notification rule for monitoring database Listeners' availability, and critical and warning metric statuses.	Listeners	Down Unreachable Start Unreachable End	N/A

Table 9–4 (Cont.) Default Notification Rules

Name	Description	Target Type	Send Notification on the Following Availability States	Send Notification on the Following Metrics and their CRITICAL and WARNING States
Host Availability and Critical/Warning States	System-generated notification rule for monitoring Hosts' availability, and critical and warning metric statuses.	Hosts	Down Unreachable Start Unreachable End	Metric Label: Average Disk I/O Service Time (ms) Metric Name: DiskActivity Metric Column: DiskActivityavserv Metric Label: Average I/O Wait Time (ms) Metric Name: DiskActivity Metric Column: DiskActivityavwait Metric Label: CPU in IO-Wait (%) Metric Name: Load Metric Column: cpuIOWait Metric Label: Disk Utilization (%) Metric Name: DiskActivity Metric Column: DiskActivitybusy Metric Label: Run Queue Length (5 minute average) Metric Name: Load Metric Column: cpuLoad Metric Column: swapUtil Metric Column: PctAvailable Metric Label: File System Space Available (%) Metric Name: Filesystems Metric Label: Memory Page Scan Rate (per second) Metric Name: Load Metric Column: pgScanRate Metric Label: CPU Utilization (%) Metric Name: Load Metric Column: cpuUtil Metric Label: Memory Utilization (%) Metric Name: Load Metric Column: MemUsedPct Metric Label: Network Interface Combined Utilization (%) Metric Name: Network Metric Label: Swap Utilization (%) Metric Name: Load Metric Column: totalThroughput

Table 9–4 (Cont.) Default Notification Rules

Name	Description	Target Type	Send Notification on the Following Availability States	Send Notification on the Following Metrics and their CRITICAL and WARNING States
Repository Operations Availability	System-generated notification rule for monitoring the availability of the DBMS jobs that are part of the Management Repository.	Oracle Management Service and Repository	Critical	Metric Name: DBMS_Job_Status Metric Column: jobUpDown
Agent Upload Problems	System-generated notification rule for monitoring Agents that may have problems uploading data to the Management Service.	Oracle Management Service and Repository	Critical	Metric Name: Targets_not_uploading Metric Column: targetCount
Agents Unreachable	System-generated notification rule for monitoring Agents that lose contact with the Management Service due to network problems, host problems or Agents going down.	Agents	Unreachable Start Unreachable End	N/A

9.5 Creating Your Own Notification Rules

To create your own notification rule:

1. From the Enterprise Manager Grid Control, click **Preferences**.
2. Click **My Rules** in the vertical navigation bar.

If you are not logged in as an administrator with superuser privileges, you will see a link for **My Rules** instead of Notification Rules as in the case of an administrator with superuser privileges.

3. Click **Create**.

Enterprise Manager displays the Create Notification Rule wizard. Follow the instructions in the wizard to create your notification rule.

When you specify the notification rule properties, check **Make Public** in the Properties page of the wizard if you want other non-privileged users to be able to view and share that rule. For example, it allows other administrators to later specify that they should receive e-mail for this rule.

When you specify the notification rule, you will only be able to choose from e-mail and SNMP traps. Specifying custom commands and PL/SQL procedures is an option which is only available to privileged users.

9.6 Getting Email Notifications

If you want to receive notifications by email, you will need to specify your e-mail address in the Preferences General page. In addition to defining notification e-mail

addresses, you associate the notification message format (long or short) to be used for each e-mail address.

Each e-mail address can have up to 132 characters; there is no upper bound with the number of e-mail addresses.

To add an e-mail address:

1. From the Grid Control, click **Preferences** at the top of the page. By default the General page is selected.
2. Click **Add Another Row** to create a new e-mail entry field in the **E-mail Addresses** table.
3. Specify the e-mail associated with your Enterprise Manager account. All e-mail notifications you receive from Enterprise Manager will be sent to the e-mail addresses you specify.

For example, `user1@oracle.com`

Select the message format for your e-mail address. The Long Format sends a HTML formatted e-mail that contains detailed information about an alert. [Example 9-12](#) shows a typical notification that uses the long format.

The Short Format ([Example 9-13](#)) sends a concise text e-mail that is limited to 155 characters thereby allowing the e-mail be received as an SMS message or page. The subject contains the severity type (for example, Critical) and the target name. The body contains the time the severity occurred and the severity message. Since the message length is limited to 155 character, some of this information may be truncated. If truncation has occurred there will be a series of dots at the end of the message.

4. Click **Apply** to save your e-mail address.

Example 9-12 Long E-mail Notification

```
Name=myhost.com
Type=Host
Host=myhost.com
Metric=Filesystem Space Available (%)
Mount Point =/usr
Timestamp=06-OCT-2003 16:27:05 US/Pacific
Severity=Warning
Message=Filesystem / has only 76.07% available space
Rule Name=Host Availability and Critical States
Rule Owner=SYSMAN
```

Example 9-13 Short E-mail notification

```
Subject is :
EM:Unreachable Start:myhost
Body is :
Nov 16, 2003 2:02:19 PM EST:Agent is Unreachable (REASON = Connection refused)
but the host is UP
```

9.6.1 Notification Schedules

Once you have defined your e-mail notification addresses, you will need to define a notification schedule. For example, if your e-mail addresses are `user1@oracle.com`, `user2@oracle.com`, `user3@oracle.com`, you can choose to use one or more of these e-mail addresses for each time period in your notification schedule.

A notification schedule is a rotating schedule used by Enterprise Manager to determine how to send e-mail notifications to administrators. Each administrator has exactly one notification schedule. When an alert needs to be e-mailed to an administrator, Enterprise Manager consults that administrator's notification schedule to determine the e-mail address to be used.

To define a notification schedule:

1. From the Enterprise Manager Grid Control, click **Preferences** at the top of the page. By default the General page is selected.

2. Click **Notification Schedule** in the vertical navigation bar.

The Enterprise Manager Grid Control displays the Notification Schedule page.

3. Follow the directions on the Notification Schedule page to specify what times you should be notified by e-mail.

9.6.2 Using Out-of-Box Notification Rules

Enterprise Manager creates a comprehensive set of predefined notification rules for the most common target types. These default rules are adequate for most notification needs situations. See "[Default Notification Rules](#)" on page 9-13 for more information. If these rules meet your needs, you can choose to receive e-mail for them by selecting the rule from the Preferences Rules or Public Rules page, then click the **Assign Methods** button.

9.6.3 Creating Your Own Notification Rules

If you find that the default notification rules do not meet your needs, you can define your own custom rules. See "[Notification Rules](#)" on page 9-12.

The e-mail format is HTML. The target Name is a link to the target in the Grid Control. The metric name is a link to the metric in the Grid Control.

9.7 Configuring Methods for Rules

After you set up your notification method or methods and created rules, you can associate the rules with multiple notification methods.

1. From the Enterprise Manager Grid Control, click **Preferences** at the top of the page.

2. Click **Notification Rules** in the vertical navigation bar.

The Enterprise Manager Grid Control displays the Notification Rules page. Any notification rules already created are listed in the **Notification Rules** table.

3. Select the radio button next to the rule for which you want to configure a method.

4. Click **Configure Methods**.

5. Specify the notification methods that should occur when metric severities are met.

Choose the **Send Me E-mail** option and specify one or more e-mail addresses to which notifications will be sent; then choose a notification method from the list of notification methods.

Once you have defined your notification methods and have decided which notification rules to use (predefined or custom), you need to define the association between various methods and rules. If you have a large number of rules, methods, or both, Enterprise Manager provides an easy way to perform method-rule mapping.

"Assigning Methods to Rules" on page 9-20 and "Assigning Rules to Methods" on page 9-20 illustrate how to perform this mapping quickly and easily.

9.8 Assigning Methods to Rules

For each notification rule, you can assign one or more notification methods to be called as a result of alert occurrences.

1. From the Enterprise Manager Grid Control, click **Preferences** at the top of the page.
2. Click **Notification Rules** in the vertical navigation bar.

The Enterprise Manager Grid Control displays the Notification Rules page. Any notification rules already created are listed in the **Notification Rules** table.

3. Click **Assign Methods to Multiple Rules**.
4. Perform your assignments.

Figure 9–2 Assigning Methods to Rules

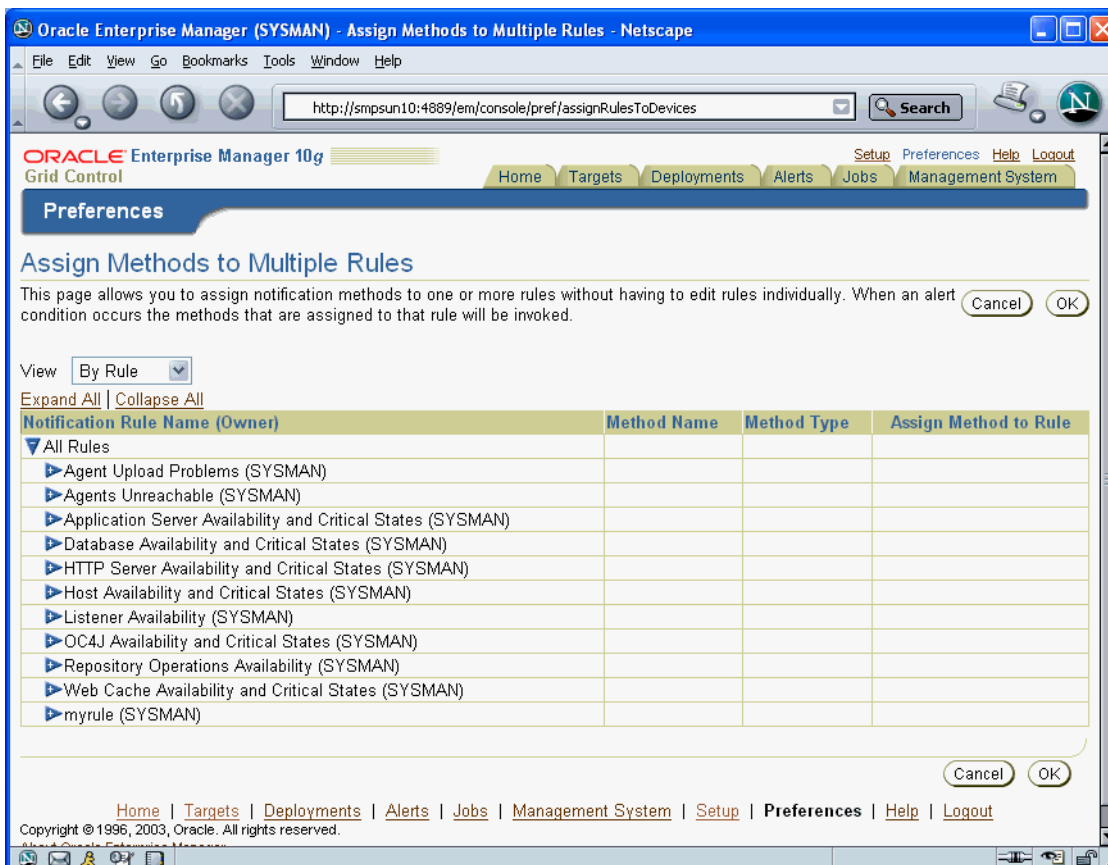

9.9 Assigning Rules to Methods

For each notification method, you can associate one or more notification rules that will use that method to send notifications.

1. From the Enterprise Manager Grid Control, click **Preferences** at the top of the page.

2. Click **Notification Rules** in the vertical navigation bar.
The Enterprise Manager Grid Control displays the Notification Rules page. Any notification rules already created are listed in the **Notification Rules** table.
3. Click **Assign Methods to Multiple Rules**.
4. From the **View** menu, select **By Method**.
5. Perform your assignments.

Figure 9–3 Assign Rules to Methods



9.10 Management Information Base (MIB)

While SNMP allows Enterprise Manager to send information to third-party SNMP-enabled applications, there may be situations where you want SNMP-enabled applications to obtain information from Enterprise Manager. This is accomplished using management information base (MIB) variables. The following sections discuss Enterprise Manager MIB variables in detail.

9.10.1 About MIBs

A MIB is a text file, written in ASN.1 notation, which describes the variables containing the information that SNMP can access. The variables described in a MIB, which are also called MIB objects, are the items that can be monitored using SNMP. There is one MIB for each element being monitored. Each monolithic or subagent consults its respective MIB in order to learn the variables it can retrieve and their characteristics. The encapsulation of this information in the MIB is what enables

master agents to register new subagents dynamically — everything the master agent needs to know about the subagent is contained in its MIB. The management framework and management applications also consult these MIBs for the same purpose. MIBs can be either standard (also called public) or proprietary (also called private or vendor).

The actual values of the variables are not part of the MIB, but are retrieved through a platform-dependent process called “instrumentation”. The concept of the MIB is very important because all SNMP communications refer to one or more MIB objects. What is transmitted to the framework is, essentially, MIB variables and their current values.

9.10.2 Reading the MIB Variable Descriptions

This section covers the format used to describe MIB variables. Note that the STATUS element of SNMP MIB definition, Version 2, is not included in these MIB variable descriptions. Since Oracle has implemented all MIB variables as CURRENT, this value does not vary.

9.10.2.1 Variable Name

Syntax

Maps to the SYNTAX element of SNMP MIB definition, Version 2.

Max-Access

Maps to the MAX-ACCESS element of SNMP MIB definition, Version 2.

Status

Maps to the STATUS element of SNMP MIB definition, Version 2.

Explanation

Describes the function, use and precise derivation of the variable. (For example, a variable might be derived from a particular configuration file parameter or performance table field.) When appropriate, incorporates the DESCRIPTION part of the MIB definition, Version 2.

Typical Range

Describes the typical, rather than theoretical, range of the variable. For example, while integer values for many MIB variables can theoretically range up to 4294967295, a typical range in an actual installation will vary to a lesser extent. On the other hand, some variable values for a large database can actually exceed this “theoretical” limit (a “wraparound”). Specifying that a variable value typically ranges from 0 to 1,000 or 1,000 to 3 billion will help the third-party developer to develop the most useful graphical display for the variable.

Significance

Describes the significance of the variable when monitoring a typical installation. Alternative ratings are Very Important, Important, Less Important, or Not Normally Used. Clearly, the DBA will want to monitor some variables more closely than others. However, which variables fall into this category can vary from installation to installation, depending on the application, the size of the database, and on the DBA’s objectives. Nevertheless, assessing a variable’s significance relative to the other variables in the MIB can help third-party developers focus their efforts on those variables of most interest to the most DBAs.

Related Variables

Lists other variables in this MIB, or other MIBs implemented by Oracle, that relate in some way to this variable. For example, the value of this variable might derive from

that of another MIB variable. Or perhaps the value of this variable varies inversely to that of another variable. Knowing this information, third-party developers can develop useful graphic displays of related MIB variables.

Suggested Presentation

Suggests how this variable can be presented most usefully to the DBA using the management application: as a simple value, as a gauge, or as an alarm, for example.

9.10.3 MIB Definition

[Example 9-14](#) shows a typical MIB definition used by Enterprise Manager.

Example 9-14 MIB Definition

```
ORACLE-ENTERPRISE-MANAGER-4-MIB DEFINITIONS ::= BEGIN

IMPORTS
TRAP-TYPE
FROM RFC-1215
DisplayString
FROM RFC1213-MIB
OBJECT-TYPE
FROM RFC-1212
enterprises
FROM RFC1155-SMI;

oracle OBJECT IDENTIFIER ::= { enterprises 111 }

oraEM4 OBJECT IDENTIFIER ::= { oracle 15 }

oraEM4Objects OBJECT IDENTIFIER ::= { oraEM4 1 }

oraEM4AlertTable OBJECT-TYPE
    SYNTAX SEQUENCE OF OraEM4AlertEntry
    ACCESS not-accessible
    STATUS mandatory
    DESCRIPTION
        "Information on alerts generated by Oracle Enterprise Manager. This table
is not queryable; it exists only to document the variables included in the
oraEM4Alert trap. Each trap contains a single instance of each variable in the
table."
    ::= { oraEM4Objects 1 }

oraEM4AlertEntry OBJECT-TYPE
    SYNTAX OraEM4AlertEntry
    ACCESS not-accessible
    STATUS mandatory
    DESCRIPTION
        "Information about a particular Oracle Enterprise Manager alert."
    INDEX { oraEM4AlertIndex }
    ::= { oraEM4AlertTable 1 }

OraEM4AlertEntry ::=
    SEQUENCE {
        oraEM4AlertIndex
            INTEGER,

        oraEM4AlertTargetName
            DisplayString,
```

```

        oraEM4AlertTargetType
DisplayString,

        oraEM4AlertHostName
DisplayString,

        oraEM4AlertMetricName
DisplayString,

        oraEM4AlertKeyName
DisplayString,

        oraEM4AlertKeyValue
DisplayString,

        oraEM4AlertTimeStamp
DisplayString,

        oraEM4AlertSeverity
DisplayString,

        oraEM4AlertMessage
DisplayString,

        oraEM4AlertRuleName
DisplayString

        oraEM4AlertRuleOwner
DisplayString
    }

oraEM4AlertIndex OBJECT-TYPE
    SYNTAX  INTEGER
    ACCESS  read-only
    STATUS  mandatory
    DESCRIPTION
        "Index of a particular alert, unique only at the moment an alert is
generated."
    ::= { oraEM4AlertEntry 1 }

oraEM4AlertTargetName OBJECT-TYPE
    SYNTAX  DisplayString
    ACCESS  read-only
    STATUS  mandatory
    DESCRIPTION
        "The name of the target to which this alert applies."
    ::= { oraEM4AlertEntry 2 }

oraEM4AlertTargetType OBJECT-TYPE
    SYNTAX  DisplayString
    ACCESS  read-only
    STATUS  mandatory
    DESCRIPTION
        "The type of the target to which this alert applies."
    ::= { oraEM4AlertEntry 3 }

oraEM4AlertHostName OBJECT-TYPE
    SYNTAX  DisplayString
    ACCESS  read-only
    STATUS  mandatory

```



```
DESCRIPTION
    "The name of the host on which this alert originated."
 ::= { oraEM4AlertEntry 4 }

oraEM4AlertMetricName OBJECT-TYPE
    SYNTAX DisplayString
    ACCESS read-only
    STATUS mandatory
    DESCRIPTION
        "The name of the metric which generated this alert."
 ::= { oraEM4AlertEntry 5 }

oraEM4AlertKeyName OBJECT-TYPE
    SYNTAX DisplayString
    ACCESS read-only
    STATUS mandatory
    DESCRIPTION
        "The name of the key-column, if present, for the metric which generated this
 alert."
 ::= { oraEM4AlertEntry 6 }

oraEM4AlertKeyValue OBJECT-TYPE
    SYNTAX DisplayString
    ACCESS read-only
    STATUS mandatory
    DESCRIPTION
        "The value of the key-column, if present, for the metric which generated this
 alert."
 ::= { oraEM4AlertEntry 7 }

oraEM4AlertTimeStamp OBJECT-TYPE
    SYNTAX DisplayString
    ACCESS read-only
    STATUS mandatory
    DESCRIPTION
        "The time at which this alert was generated."
 ::= { oraEM4AlertEntry 8 }

oraEM4AlertSeverity OBJECT-TYPE
    SYNTAX DisplayString
    ACCESS read-only
    STATUS mandatory
    DESCRIPTION
        "The severity of the alert e.g. Critical."
 ::= { oraEM4AlertEntry 9 }

oraEM4AlertMessage OBJECT-TYPE
    SYNTAX DisplayString
    ACCESS read-only
    STATUS mandatory
    DESCRIPTION
        "The message associated with the alert."
 ::= { oraEM4AlertEntry 10 }

oraEM4AlertRuleName OBJECT-TYPE
    SYNTAX DisplayString
    ACCESS read-only
    STATUS mandatory
    DESCRIPTION
        "The name of the notification rule that caused this notification."
```

```
 ::= { oraEM4AlertEntry 11 }

oraEM4AlertRuleOwner OBJECT-TYPE
    SYNTAX DisplayString
    ACCESS read-only
    STATUS mandatory
    DESCRIPTION
        "The owner of the notification rule that caused this notification."
    ::= { oraEM4AlertEntry 12 }

oraEM4Traps OBJECT IDENTIFIER ::= { oraEM4 2 }

oraEM4Alert TRAP-TYPE
    ENTERPRISE oraEM4Traps
    VARIABLES { oraEM4AlertTargetName, oraEM4AlertTargetType,
                oraEM4AlertHostName, oraEM4AlertMetricName,
                oraEM4AlertKeyName, oraEM4AlertKeyValue, oraEM4AlertTimeStamp,
                oraEM4AlertSeverity, oraEM4AlertMessage,
                oraEM4AlertRuleName, oraEM4AlertRuleOwner }
    DESCRIPTION
        "The variables included in the oraEM4Alert trap."
    ::= 1

END
```

Additional Configuration Tasks

This chapter contains the following sections:

- [Understanding Default and Custom Data Collections](#)
- [Enabling Multi-Inventory Support for Configuration Management](#)
- [Manually Configuring a Database Target for Complete Monitoring](#)
- [Modifying the Default Login Timeout Value](#)

10.1 Understanding Default and Custom Data Collections

For each target you manage, Enterprise Manager sets up a default set of metrics to collect. For example, when install the Oracle Management Agent, Enterprise Manager automatically begins gathering a default set of metrics that you can use to monitor the performance and availability of the host computer. Similarly, when you add or configure a database target, you can select from three collection options. You can select **Minimum**, **Recommended**, or **Complete**. Each of these options enables a different set of performance metrics and default thresholds for those metrics.

See Also: "About Thresholds" in the Enterprise Manager online help

10.1.1 How Enterprise Manager Stores Default Collection Information

Enterprise Manager stores the default collection criteria for each target in the following location on each Oracle Management Agent host:

`AGENT_HOME/sysman/admin/default_collection/`

For some targets, you can use the Oracle Enterprise Manager 10g Grid Control to modify the default metric collection settings. For example, you can change the level of monitoring for your database targets or modify the default thresholds for your host targets. When you make these types of modifications, Enterprise Manager creates a new default collection file in the following directory:

`AGENT_HOME/sysman/emd/collection/`

This collection file overrides the default collection information stored in the `sysman/admin/default_collection` directory.

10.1.2 Restoring Default Collection Settings

If you have made modifications to the metric thresholds for a particular target, you can restore the default metric collection settings by deleting the customized collection information in the `sysman/emd/collection` directory.

For example, if you want to restore the default collections for a particular database target, remove the customized collection file for that target from the `sysman/emd/collection` directory. Enterprise Manager will begin using the metric collection information stored in the `sysman/admin/default_collection` directory.

10.2 Enabling Multi-Inventory Support for Configuration Management

Every time you install an Oracle software product on a host computer, Oracle Universal Installer saves information about the software installation on your hard disk. The directories and files that contain this software configuration information are referred to as the Oracle Universal Installer inventory.

See Also: Oracle Universal Installer Concepts Guide

When you use Enterprise Manager to monitor your Oracle software installations, Enterprise Manager takes advantage of information saved in the Universal Installer inventory.

As it gathers information about the configuration of your host computer, by default, Enterprise Manager assumes that you have one Oracle Universal Installer inventory on the host. Specifically, Enterprise Manager recognizes the inventory that Oracle Universal Installer uses when you run the Universal Installer on the host.

However, in some cases, you may have more than one inventory. For example, you may have worked with Oracle Support to clone your Oracle software installations. For those cases, you can use the following procedure to be sure that Enterprise Manager can track and manage the software information in multiple inventories on the same host.

Caution: Enabling support for multiple inventories is optional and available only for advanced users who are familiar with the Oracle Universal Installer inventory architecture and who have previously worked with multiple inventories on a managed host. This procedure is not required for hosts where normal installations have been performed.

To set up Enterprise Manager so it can read multiple inventories on a host:

1. Locate the `OUIinventories.add` file in the following directory:

`AGENT_HOME/sysman/config/`

2. Open `OUIinventories.add` using a text editor.

Instructions within the file describe the format to use when identifying multiple inventories, as well other techniques for mapping Oracle Homes.

3. Carefully review the instructions within the file.
4. Add entries to the file for each additional inventory on the managed host.
5. Save your changes and close the file.

During its next collection of host configuration information, Enterprise Manager will start gathering software configuration information from the inventories that you identified in the `OUIinventories.add` file, in addition to the default inventory that Enterprise Manager normally collects.

Alternatively, to see the data gathered from the additional inventories before the next regularly-scheduled collection, navigate to the Host home page in the Grid Control, click the **Configuration** tab, and click the Refresh Data icon next to the page timestamp.

Note: If there are any irrecoverable problems during the collection of the default inventory (for example, if the inventory file or directory protections prevent Enterprise Manager from reading the inventory), inventories listed in `OUIinventories.add` file are also not collected.

If the Enterprise Manager is able to read the default inventory, but there is a problem reading an additional inventory listed in the `OUIinventories.add` file, Enterprise Manager issues a collection warning for those inventories, but Enterprise Manager does collect the configuration information for the other inventories.

10.3 Manually Configuring a Database Target for Complete Monitoring

When you monitor Oracle Database 10g database, no additional configuration is necessary the Grid Control requires no additional configuration required after you discover the database target.

However, when you monitor an Oracle9i database or an Oracle8i database, there is some additional configuration required if you want to monitor certain types of database performance metrics. using the Grid Control.

To monitor these additional performance metrics Enterprise Manager requires that Oracle Statspack and some additional Enterprise Manager packages be installed and configured in the database you are monitoring.

See Also: "Using Statspack" in *Oracle Database Performance Tuning Guide* in the Oracle9i Documentation Library

If these additional objects are not available and configured in the database, Enterprise Manager will not be able to gather the data for the complete set of performance metrics. In addition, Enterprise Manager will not be able to gather information that otherwise could be readily available from the Database home page, such as Bad SQL and the Top SQL Report.

You can use the Configure Database wizard in the Grid Control to install the required packages into the database, or you can use the following manual procedure.

See Also: "Modifying Target Properties" in the Enterprise Manager online help for information on configuring managed targets, including database targets.

To manually install Statspack and the other required database objects into an Oracle9i database that you are managing with Enterprise Manager, you can use SQL*Plus and the following procedure:

1. Log in to the database host using an account with privileges that allow you to write to the database home directory and to the Management Agent home directory.

For each of the commands in this procedure, replace AGENT_HOME with the actual path to the Oracle Management Agent home directory and replace ORACLE_HOME with the path to database home directory.

2. Start SQL*Plus and connect to the database using the SYS account with SYSDBA privileges.

For example:

```
$PROMPT> ./sqlplus "connect / as sysdba"
```

3. Enter the following command to run the Database dbmon script:

```
SQL> @AGENT_HOME/sysman/admin/scripts/db/config/dbmon
```

The script will display the following prompt:

```
Enter value for dbm_password:
```

4. When prompted, enter the password for the DBSNMP account.

The script performs several configuration changes and returns you to the SQL*Plus prompt.

5. Connect as the DBSNMP user.

For example:

```
SQL> connect DBSNMP
```

6. Enter the following command:

```
SQL> @AGENT_HOME/sysman/admin/scripts/db/config/response.plb
SQL> grant EXECUTE on dbsnmp.mgmt_response to OEM_MONITOR;
```

7. Connect as SYS enter the following command to create the PERFSTAT user:

```
SQL> @ORACLE_HOME/rdbms/admin/spcreate
```

Note: The spcreate script will prompt you for a default tablespace and default temporary tablespace for the PERFSTAT user. Do not specify the SYSTEM tablespace as the default tablespace for the PERFSTAT user. For more information, see "Using Statspack" in the *Oracle Database Performance Tuning Guide*.

8. Connect as the PERFSTAT user.

For example:

```
SQL> connect PERFSTAT;
```

9. Enter the following commands from the PERFSTAT user account:

```
SQL> define snap_level='6';
SQL> define cinterval='1';
SQL> define cjobno='-1';
SQL> @AGENT_HOME/sysman/admin/scripts/db/config/spset
```

10. Connect as the SYS user and enter the following command:

```
SQL> grant OEM_MONITOR to dbsnmp;
```

- 11.** If the database you are modifying is an Oracle8i database, also enter the following commands as the SYS user:

```
grant select on sys.ts$ to OEM_MONITOR;
grant select on sys.seg$ to OEM_MONITOR;
grant select on sys.user$ to OEM_MONITOR;
grant select on sys.obj$ to OEM_MONITOR;
grant select on sys.sys_objects to OEM_MONITOR;
grant select on sys.file$ to OEM_MONITOR;
grant select on sys.attrcol$ to OEM_MONITOR;
grant select on sys.clu$ to OEM_MONITOR;
grant select on sys.col$ to OEM_MONITOR;
grant select on sys.ind$ to OEM_MONITOR;
grant select on sys.indpart$ to OEM_MONITOR;
grant select on sys.indsubpart$ to OEM_MONITOR;
grant select on sys.lob$ to OEM_MONITOR;
grant select on sys.lobfrag$ to OEM_MONITOR;
grant select on sys.partobj$ to OEM_MONITOR;
grant select on sys.tab$ to OEM_MONITOR;
grant select on sys.tabpart$ to OEM_MONITOR;
grant select on sys.tabsubpart$ to OEM_MONITOR;
grant select on sys.undo$ to OEM_MONITOR;
```

- 12.** For any supported database version, enter the following command from the SYS account:

```
SQL> show parameter job_queue_processes
```

If the output from the show parameter command is zero, then perform the following steps to modify the `job_queue_processes` initialization parameter:

If you start the database using an spfile, enter the following command:

```
SQL> alter system set job_queue_processes = 2 SCOPE=BOTH;
```

Otherwise, do the following:

- a.** Enter the following command:

```
SQL> alter system set job_queue_processes = 2;
```

- b.** Exit SQL*PLUS and update the `init.ora` database configuration file with the following entry so the parameter will be applied whenever the database is restarted:

```
job_queue_processes=2
```

- 13.** Exit SQL*Plus and change directory to the following directory in the home directory of the Management Agent that is monitoring the database:

```
AGENT_HOME/bin
```

- 14.** Reload the agent by entering the following command:

```
$PROMPT> ./emctl agent reload
```

- 15.** Using Grid Control, return to the Database home page and verify that the Bad SQL and Top SQL Report metrics are now being gathered.

10.4 Modifying the Default Login Timeout Value

To prevent unauthorized access to the Grid Control, Enterprise Manager will automatically log you out of the Grid Control when there is no activity for a predefined period of time. For example, if you leave your browser open and leave your office, this default behavior prevents unauthorized users from using your Enterprise Manager administrator account.

By default, if the system is inactive for 45 minutes or more, and then you attempt to perform an Enterprise Manager action, you will be asked to log in to the Grid Control again.

To increase or decrease the default timeout period:

1. Change directory to the following location in the Oracle Application Server home directory where the Management Service was deployed:

```
IAS_HOME/sysman/config/
```

2. Using your favorite text editor, open the `emoms.properties` file and add the following entry:

```
oracle.sysman.eml.maxInactiveTime=time_in_minutes
```

3. For example, if you want to change the default timeout period to one hour, add the following entry:

```
oracle.sysman.eml.maxInactiveTime=60
```

4. Save and close the `emoms.properties` file.
5. Restart the Management Service.

Note: The default timeout value does not apply when you restart the Web server or the Oracle Management Service. In both of those cases, you will be asked to log in to the Grid Control, regardless of the default timeout value.

Index

A

accessibility

- enabling accessibility mode, 1-26
- enabling accessibility features, 1-26
- providing textual descriptions of charts, 1-27

Additional Management Agent installation type, 1-4

advanced configuration

- introduction, 1-1
- types of tasks, 1-1

Agent Registration Password, 2-6

- changing, 2-12

Agent Upload Problems

- default notification rule, 9-17

AGENT_HOME

- definition, 1-4, 1-5

AGENT_HOME/bin, 1-5

AGENT_HOME/network/admin, 2-17

AGENT_HOME/sysman, 1-5

AGENT_HOME/sysman/admin

- /scripts/db/config/response.pl, 10-4

AGENT_HOME/sysman/config, 1-5

AGENT_HOME/sysman/log, 1-5

agentInstallJob.tcl, 8-2

Agents Unreachable

- default notification rule, 9-17

aggregation and purging policies

- See* data retention policies

analyzing tables

- after adding many Grid Control targets, 6-6
- sample SQL for manually analyzing Management Repository tables, 6-6

Application Performance Management, 2-28, 3-9

- before configuring, 4-1
- configuring, 4-1
- configuring End-User Response Time Monitoring, 4-3, 4-8
- configuring Interactive Tracing for Business Transactions, 4-3
- configuring Middle-Tier URL Performance Monitoring, 4-3
- configuring Transaction Performance Monitoring, 4-2
- summary of configuration tasks, 4-1

Application Performance Monitoring

- confirming that End-User Response Time

- Monitoring is enabled, 4-14

Application Server Availability and Critical/Warning States

- default notification rule, 9-13

Application Server Control

- directory structure, 1-5
- introduction, 1-5
- Ports page, 3-10
- security, 2-17
- starting and stopping, 1-18

archive logging

- for Management Repository database, 6-2

assistive technology, 1-26

audience

- intended audience, -xi

Automatic Storage Management

- when configuring Database Control, 1-11

B

Bad SQL

- configuring the database to show Bad SQL, 10-3

Beacons

- configuring firewalls to allow ICMP traffic, 3-9
- Local Beacon, 4-4
- monitoring Web Applications over HTTPS, 2-28

blackouts

- controlling with emctl, 1-24
- examples, 1-26

Business Transaction Tracing

- configuring, 4-5

C

Certificate dialog box

- Internet Explorer, 2-25, 2-26, 2-28

charts

- providing textual descriptions for accessibility, 1-27

chronos_setup.sh, 4-9

- configuring OracleAS Web Cache, 4-10
- configuring the Web Server, 4-9
- starting End-User Response Time Monitoring, 4-11

collection directory, 10-1

connect descriptor

- using to identify the Management Repository database, 6-9, 6-10
- conventions
 - used in this guide, -xii
- Create Administrator Page
 - when SSO support is enabled, 2-23

D

- data collections
 - how Enterprise Manager stores, 10-1
 - restoring default, 10-1
 - understanding default and custom, 10-1
- Data Guard
 - configuring Enterprise Manager availability, 6-1
- data retention policies
 - default settings, 6-3
 - for Application Performance Management data, 6-3
 - for other Management data, 6-3
 - modifying default, 6-3
 - of the Management Repository, 6-2
 - when targets are deleted, 6-5
- Database Availability and Critical/Warning States
 - default notification rule, 9-15
- Database Configuration Assistant
 - See DBCA
- Database Control
 - configuring after installation, 1-7, 1-10
 - configuring during installation, 1-7
 - configuring with DBCA, 1-8
 - configuring with EMCA, 1-10
 - directory structure, 1-6
 - enabling security for, 2-18
 - introduction, 1-6
 - location of Management Agent and Management Service support files, 1-6
 - removing from a Real Application Clusters node, 1-11
 - removing with EMCA, 1-11
 - starting on UNIX, 1-18
 - stopping on UNIX, 1-19
- db_recovery_file_dest initialization parameter, 1-11
- DBCA
 - configuring Database Control with, 1-8
 - Management Options page, 1-10
 - starting on UNIX, 1-9
 - starting on Windows, 1-9
- DBSNMP database user, 1-22
 - setting the password for, 1-22
- DBSNMP user, 10-4
- default_collection directory, 10-1
- deleting targets
 - data retention policies when, 6-5
- directory structure
 - important Management Service directories, 1-3
 - introduction to, 1-1
- disk mirroring and stripping
 - Management Repository guideline, 6-1
- disk space management

- controlling Management Agent disk space, 7-3
- controlling the contents of trace files, 5-4
- controlling the size and number of log and trace files, 5-3, 5-5, 5-6
- controlling the size of log and trace files, 5-8
- document root
 - finding, 4-10
- dontProxyFor
 - description of property, 3-6
 - property in emoms.properties, 3-6
- dropping the Management Repository, 6-8

E

- EM Website Web Application target, 4-1
- emagent.log, 5-1
- emagentlogging.properties, 5-5
 - log4j.rootCategory property, 5-6
 - MaxBackupIndex property, 5-5
 - MaxFileSize property, 5-5
- emagent.nohup, 5-2
- emagent.trc, 5-2
- EMCA
 - command-line arguments, 1-11
 - configuring Database Control for Real Application Clusters, 1-13
 - configuring Database Control with, 1-10
 - sample EMCA input file, 1-12
 - troubleshooting problems with the Database Control, 1-13
 - using an input file for EMCA parameters, 1-12
- emctl, 1-14
 - controlling blackouts, 1-24
 - listing targets on a managed host, 1-23
 - location in AGENT_HOME, 1-5
 - security commands, 2-6
 - setting monitoring credentials, 1-23
 - starting, stopping, and checking the Management Service, 1-16
- emctl config agent credentials, 1-23, 6-7
- emctl config agent listtargets, 1-24, 6-7
- emctl config oms
 - sample output, 2-21
- emctl config oms sso, 2-20
- emctl reload, 1-22
- emctl secure agent, 2-8
 - sample output, 2-10
- emctl secure dbconsole, 2-19
- emctl secure em, 2-18
 - sample output, 2-18
- emctl secure lock, 2-11
- emctl secure oms, 2-6, 2-7
 - sample output, 2-8
- emctl secure setpwd, 2-13
- emctl secure unlock, 2-11
- emctl start agent, 1-14
- emctl start blackout, 1-25
- emctl start dbconsole, 1-19
- emctl start iasconsole, 1-18
- emctl start oms, 1-17

- emctl status agent, 1-15
- emctl status blackout, 1-25
- emctl status oms, 1-17
- emctl stop agent, 1-14
- emctl stop blackout, 1-25
- emctl stop dbconsole, 1-19
- emctl stop iasconsole, 1-18
- emctl stop oms, 1-17
- emctl upload, 1-22
- emd_maintenance.remove_em_dbms_jobs, 6-6
- emd_maintenance.submit_em_dbms_jobs, 6-7
- EMD_URL
 - property in the emd.properties file, 7-2
- emd.properties, 5-3, 7-2, 7-3
 - EMD_URL, 7-2
 - emdWalletDest, 7-2
 - emdWalletSrcUrl, 7-2
 - location, 1-5
 - LogFileMaxRolls, 5-3
 - REPOSITORY_PROXYHOST, 3-3
 - REPOSITORY_PROXYPORT, 3-3
 - REPOSITORY_URL, 7-2
 - TrcFileMaxrolls, 5-3
 - TrcFileMaxSize, 5-3
 - UploadMaxBytesXML, 7-3
 - UploadMaxDiskUsedPct, 7-4
- emdRepPort
 - property in the emoms.properties file, 7-8
- emdRepPwd
 - property in the emoms.properties file, 7-7
- emdRepPwdEncrypted
 - property in the emoms.properties file, 7-8
- emdRepServer
 - property in the emoms.properties file, 7-8
- emdRepSID
 - property in the emoms.properties file, 7-8
- emdRepUser
 - property in the emoms.properties file, 7-7
- emdWalletDest
 - property in emd.properties, 7-2
- emdWalletSrcUrl
 - property in emd.properties, 7-2
- em.notification.emails_per_minute
 - property in emoms.properties, 9-4
- em.notification.os_cmd_timeout
 - property in emoms.properties, 9-5
- emoms.log, 5-6, 5-7
- emomslogging.properties, 5-7, 5-8
 - MaxBackupIndex, 5-7
 - MaxFileSize, 5-7
- emoms.properties, 6-8, 7-7
 - dontProxyFor property, 3-6
 - emdRepPort, 7-8
 - emdRepPwd, 7-7
 - emdRepPwdEncrypted, 7-8
 - emdRepServer, 7-8
 - emdRepSID, 7-8
 - emdRepUser, 7-7
- em.notification.emails_per_connection, 9-3
 - property in emoms.properties, 9-3
- em.notification.emails_per_minute, 9-4
- em.notification.os_cmd_timeout, 9-5
- maxInactiveTime, 10-6
- oracle.net.crypto_checksum_client, 2-16
- oracle.net.crypto_checksum_types_client, 2-16
- oracle.net.encryption_client, 2-15
- oracle.net.encryption_types_client, 2-16
- oracle.sysman.eml.mntr.emdRepPwd, 6-8
- oracle.sysman.eml.mntr.emdRepPwdEncrypted, 6-8
- oracle.sysman.emRep.dbConn.enableEncryption, 2-15
- oracle.sysman.emSDK.sec.DirectoryAuthenticationType, 2-24
- oracle.sysman.emSDK.svlt
 - .ConsoleServerPort, 7-9
- proxyHost property, 3-6
- proxyPort property, 3-6
- sample Management Repository properties, 7-8
- emoms.trc, 5-6
- emwd watchdog script
 - in the AGENT_HOME/bin directory, 7-4
- enabling tracing
 - for an OC4J instance, 4-5
- End-User Response Time Monitoring
 - configuring, 4-3, 4-8
 - configuring for earlier versions of OracleAS Web Cache, 4-8
 - configuring for Oracle Application Server 10g Release 2 (9.0.4), 4-6
 - confirming that it is enabled, 4-14
 - starting, 4-11
- Enterprise Java Beans (EJBs), 4-5
- Enterprise Manager
 - See Oracle Enterprise Manager
- Enterprise Manager Configuration Assistant
 - See EMCA
- Enterprise Manager Framework Security
 - about, 2-4
 - compared with Oracle HTTP Server security features, 2-5
 - configuring, 2-4
 - enabling for Management Repository, 2-13
 - enabling for multiple Management Services, 2-10
 - enabling for the Management Agent, 2-8
 - in a firewall environment, 3-2
 - overview of steps required, 2-6
 - restricting HTTP access, 2-10
 - types of secure connections, 2-5
- Enterprise Manager Logon Page
 - when configuring SSO, 2-23
- Enterprise User Security
 - configuring Enterprise Manager for, 2-24

F

- fetchlet
 - log and trace files, 5-4
- firewalls
 - between browser and the Grid Control, 3-2

- between Grid Control and a managed database target, 3-8
- between Management Service and Management Agents, 3-8
- between Management Service and Management Repository, 3-7
- configuring for ICMP traffic, 3-9
- configuring for UDP traffic, 3-9
- configuring the Management Agent for, 3-3
- configuring the Management Service for, 3-5
- configuring to allow incoming data from Management Service, 3-7
- configuring to allow incoming traffic to Management Agent, 3-4
- considerations before configuring, 3-1
- considerations when using with multiple Management Services, 3-8
- flashback recovery area
 - when configuring Database Control, 1-11

G

- Grid Control
 - configuring notifications, 9-1
 - starting all components of, 1-19
 - stopping all components of, 1-20
- Grid Control Framework
 - starting, 1-19
 - stopping, 1-20
- guidelines
 - for deploying the Management Repository, 6-1

H

- home page URL, 4-4
- Host Availability and Critical/Warning States
 - default notification rule, 9-16
- hostname_lookup.txt, 8-5
- HTTP 500 - Internal server error, 1-17
- HTTP access
 - restricting, 2-10
- HTTP Server Availability and Critical/Warning States
 - default notification rule, 9-14
- http_em.conf, 7-9
- HTTPS, 2-5

I

- ICMP, 3-9
- Interactive Tracing for Business Transactions
 - configuring, 4-3
- Internet Control Message Protocol, 3-9
- Internet Explorer
 - Certificate dialog box, 2-25, 2-26, 2-28
 - requirement when playing back Business Transactions, 4-3
 - security alert dialog box, 2-25
 - Security Information dialog box, 2-27
- introduction to advanced configuration, 1-1

J

- J2EE, 1-2, 2-5
 - directory in Oracle Management Service home, 1-4
- javax.net.ssl.SSLException
 - SSL handshake failed, 2-28
- JDBC connections, 4-5
- job_queue_processes, 10-5
- JSPs, 4-5

L

- Listener Availability
 - default notification rule, 9-15
- Listener port
 - obtaining, 3-8
- Local Beacon, 4-4
- log files
 - controlling the content of, 5-4
 - controlling the size and number of, 5-6
 - controlling the size of, 5-3
 - fetchlet log files, 5-4
 - locating and configuring, 5-1
 - locating Management Agent, 5-2
 - locating Management Service, 5-6
 - Management Agent, 5-1
 - Oracle Management Service, 5-6
 - rollover files, 5-2
- log4j.appender.emagentlogAppender
 - .MaxBackupIndex, 5-5
- log4j.appender.emagentlogAppender
 - .MaxFileSize, 5-5
- log4j.appender.emagenttrcAppender
 - .MaxBackupIndex, 5-5
- log4j.appender.emagenttrcAppender
 - .MaxFileSize, 5-5
- log4j.appender.emlogAppender.
 - MaxBackupIndex, 5-7
- log4j.appender.emlogAppender. MaxFileSize, 5-7
- log4j.appender.emtrcAppender.
 - MaxBackupIndex, 5-7
- log4j.appender.emtrcAppender. MaxFileSize, 5-7
- log4j.rootCategory property in
 - emagentlogging.properties, 5-6
- log4j.rootCategory=WARN, emlogAppender, emtrcAppender, 5-8
- LogFileMaxRolls property in emd.properties, 5-3
- Login Timeout Value
 - modifying the default, 10-6
- LVM (Logical Volume Manager), 6-1

M

- Manage Beacons
 - link on the Administration page of the Web Application target home, 4-5
- Manage Transactions
 - link on the Administration page on the Web Application target home page, 4-5
 - link on the Web Application target Administration

- page, 4-5
- Management Agent
 - additional Management Agent commands, 1-21
 - checking the status on UNIX, 1-15
 - checking the status on Windows, 1-15
 - configuring to allow incoming communication from the Management Service, 3-4
 - configuring to use a proxy server, 3-3
 - starting and stopping on UNIX, 1-14
 - starting and stopping on Windows, 1-15
- Management Agent service
 - locating on Windows, 1-15
- Management Information Base (MIB), 9-21
 - definition, 9-21
 - MIB variable descriptions, 9-22
- Management Options page
 - in DBCA, 1-10
 - in Oracle Universal Installer, 1-8
- Management Repository
 - See Oracle Management Repository
- Management Service
 - See Oracle Management Service
- MaxBackupIndex
 - property in emomslogging.properties, 5-7
- MaxBackupIndex property in
 - emagentlogging.properties, 5-5
- MaxFileSize
 - property in emomslogging.properties, 5-7
- MaxFileSize property in
 - emagentlogging.properties, 5-5
- maxInactiveTime
 - property in emoms.properties, 10-6
- metric severity information
 - while using notifications, 9-8
- metric thresholds
 - configuring after migrating from previous versions of Enterprise Manager, 8-8
- MGMT_ADMIN.DISABLE_METRIC_DELETION, 6-5
- MGMT_ADMIN.ENABLE_METRIC_DELETION, 6-5
- MGMT_METRICS_1DAY table, 6-4
 - manually analyzing, 6-5
- MGMT_METRICS_1HOUR table, 6-4
 - manually analyzing, 6-5
- MGMT_METRICS_RAW table, 6-4
 - manually analyzing, 6-5
- MGMT_PARAMETERS table, 6-4
- MGMT_RT_datatype_1DAY table, 6-4
- MGMT_RT_datatype_1HOUR table, 6-4
- MGMT_RT_datatype_DIST_1DAY table, 6-4
- MGMT_RT_datatype_DIST_1HOUR table, 6-4
- MGMT_RT_METRICS_RAW table, 6-4
- MIB
 - See Management Information Base (MIB)
- Microsoft Internet Explorer
 - See Internet Explorer
- Middle-Tier URL Performance
 - configuring, 4-3
- migrating

- configuring metric thresholds, 8-8
- deploying and configuring Management Agents, 8-2
- from previous versions of Enterprise Manager, 8-1
- migrating management repository data, 8-7
- overview of the Enterprise Manager migration process, 8-1
- requirements, 8-1
- supported versions, 8-1
- using the repo_mig script, 8-7
- monitoring credentials
 - defined, 1-22
 - example of setting, 1-23
 - setting, 1-22
 - setting in Grid Control, 1-23
 - setting with emctl, 1-23

N

- Netscape Navigator
 - New Site Certificate dialog box, 2-26
- network/admin, 2-14, 2-15, 2-16, 2-17
- New Site Certificate dialog box
 - Netscape Navigator, 2-26
- notification methods, 9-1, 9-19
 - based on a PL/SQL Procedure, 9-5
 - based on an SNMP trap, 9-6
 - based on operating system commands, 9-4
 - definition, 9-1
 - managing, 9-2
- notification rules, 9-1, 9-19
 - creating your own, 9-17, 9-19
 - defaults, 9-13
 - definition, 9-2
 - out-of-the-box notification rules, 9-18
- notification schedules, 9-18
- notifications
 - assigning methods to rules, 9-20
 - assigning rules to methods, 9-20
 - configuring, 9-1
 - defining multiple mail servers, 9-3
 - getting email notifications, 9-17
 - long email notifications, 9-18
 - mail server settings, 9-2
 - mail server settings in emoms.properties, 9-3
 - management information base (MIB), 9-21
 - notification schedules, 9-18
 - passing information to a PL/SQL procedure, 9-10
 - passing metric severity information, 9-8
 - sample Operating System command script, 9-9
 - setting up, 9-1
 - setting up a mail server, 9-2
 - short email notifications, 9-18
 - using custom notification methods, 9-4

O

- OC4J Availability and Critical/Warning States
 - default notification rule, 9-13

- OC4J tracing
 - enabling, 4-5
- OEM_MONITOR, 10-5
- Operating System command
 - sample notification method for, 9-5
 - sample script, 9-9
- Operating System scripts, 9-2
 - while creating notification methods, 9-4
- OPMN
 - See* Oracle Process Management and Notification
- opmnctl
 - using to start Web Cache, 1-18
 - using to stop Web Cache, 1-18
- opmnctl startall, 1-16, 2-7, 2-21
- opmnctl status, 1-18
- opmnctl stopall, 1-16, 2-7, 2-20
- opmnctl stopproc ias-component=WebCache, 1-18
- ORA-12645
 - Parameter does not exist, 2-14
- Oracle Advanced Security, 2-5, 2-14, 3-7
 - enabling for Management Repository, 2-16
 - enabling for the Management Agent, 2-17
- Oracle Application Server
 - Enterprise Manager directories installed with, 1-5
 - J2EE and Web Cache installation type, 1-2
- Oracle Application Server Web Cache
 - configuring for End-User Response Time Monitoring, 4-7, 4-8
 - default port number, 1-17
 - downloading, 4-12
 - errors when not running, 1-17
 - requirement for End-User Response Time Monitoring, 4-3
 - starting and stopping, 1-17
 - starting and stopping with opmnctl, 1-18
 - using with Grid Control, 1-17
 - Web Cache Manager, 4-7
- Oracle Database 10g
 - Enterprise Manager directories installed with, 1-6
- Oracle Enterprise Manager
 - directory structure, 1-1
 - log files, 5-1
 - migrating from previous versions, 8-1
 - starting and stopping Enterprise Manager components, 1-14
 - Web Application target (EM Website), 4-1
- Oracle Enterprise Manager 10g Application Server Control
 - See* Application Server Control, 2-17
- Oracle Enterprise Manager 10g Grid Control
 - See* Grid Control
- Oracle Enterprise Manager Release 2.2, 8-1
- Oracle Enterprise Manager Release 9.0.1, 8-1
- Oracle Enterprise Manager Release 9.2, 8-1
- Oracle Internet Directory, 2-22
- Oracle Management Agent
 - about the log and trace files, 5-1
 - changing the port, 7-2
 - configuring when protected by a firewall, 3-3
 - controlling disk space used by, 7-3
 - controlling the content of trace files, 5-4
 - controlling the size of log and trace files, 5-3
 - directory structure, 1-4
 - directory structure on Windows, 1-5
 - enabling security for, 2-8, 2-17
 - fetchlet log and trace files, 5-4
 - home page, 2-10
 - installing with Grid Control, 1-4
 - location of log and trace files, 5-2
 - log and trace files, 5-1
 - log and trace rollover files, 5-2
 - reconfiguring to use a new Management Service, 7-1
 - starting and stopping, 1-14
 - Watchdog process, 7-4
- Oracle Management Repository
 - ample SQL for manually analyzing tables, 6-6
 - changing the Management Repository password, 7-8
 - configuration parameters in the emoms.properties file, 7-8
 - data retention policies, 6-2
 - deployment guidelines, 6-1
 - dropping, 6-8
 - enabling Oracle Advanced Security, 2-16
 - enabling security for, 2-13
 - identifying with a connect descriptor, 6-9, 6-10
 - manually analyzing selected tables, 6-5
 - migrating data from previous versions, 8-7
 - recreating, 6-8, 6-9
 - reloading data, 1-22
 - starting the Management Repository database, 1-20
 - troubleshooting, 6-11
 - uploading data, 1-22
- Oracle Management Service
 - about the log and trace files, 5-6
 - bin directory, 1-3
 - components installed with, 1-2
 - configuring for use with a proxy server, 3-5
 - configuring to allow incoming data from Management Agent, 3-7
 - configuring to use a new Repository, 7-7
 - configuring when protected by a firewall, 3-5
 - enabling security for, 2-6
 - enabling security for multiple Management Services, 2-10
 - home directory, 1-2
 - important directories, 1-3
 - j2ee directory, 1-4
 - location the log and trace files, 5-6
 - log and trace files, 5-6
 - modifying monitoring credentials, 1-22
 - opmn directory, 1-4
 - reconfiguring, 7-7
 - reconfiguring to use a new port, 7-8
 - starting, stopping, and checking, 1-16
 - sysman directory, 1-4
- Oracle Net firewall proxy access, 3-7, 3-8
- Oracle Process Management and Notification

- (OPMN)
 - using to start and stop the Management Service, 1-16
- Oracle Process Manager and Notification (OPMN), 1-4
- Oracle Technology Network (OTN), 4-12
- Oracle Universal Installer
 - Management Options page, 1-8
- ORACLE_HOME/bin, 1-3
- ORACLE_HOME/hostname_sid/, 1-6
- ORACLE_HOME/install, 3-9
- ORACLE_HOME/j2ee, 1-4
- ORACLE_HOME/network/admin, 2-14, 2-15, 2-16
- ORACLE_HOME/oc4j/j2ee, 1-6
- ORACLE_HOME/oc4j/j2ee/OC4J_DBCConsole, 1-6
- ORACLE_HOME/opmn, 1-4
- ORACLE_HOME/opmn/bin, 1-17
- ORACLE_HOME/sysman, 1-4, 1-6
- ORACLE_HOME/sysman/agent_download/, 8-2
- oracle_smp_chronos directory, 4-9
- oracle_smp_chronos.gif, 4-9
- oracle_smp_chronos.js, 4-9
- Oracle8i database
 - configuring for monitoring, 10-3
- Oracle9i database
 - configuring for monitoring, 10-3
- oracle.net.crypto_checksum_client
 - property in emoms.properties, 2-16
- oracle.net.crypto_checksum_types_client
 - property in emoms.properties, 2-16
- oracle.net.encryption_client
 - property in emoms.properties, 2-15
- oracle.net.encryption_types_client
 - property in emoms.properties, 2-16
- oracle.sysman.eml.mntr.emdRepPwd
 - property in emoms.properties, 6-8
- oracle.sysman.eml.mntr.emdRepPwdEncrypted
 - property in emoms.properties, 6-8
- oracle.sysman.emRep.dbConn.enableEncryption
 - entry in emoms.properties, 2-15
- oracle.sysman.emSDK.sec.DirectoryAuthenticationType
 - property in emoms.properties, 2-24
- oracle.sysman.emSDK.svlt.ConsoleServerPort
 - property in emoms.properties file, 7-9
- OS scripts
 - See Operating System scripts
- OTN (Oracle Technology Network), 4-12
- OUIinventories.add, 10-2

P

- Package Body Does Not Exist
 - error while creating the Repository, 6-11
- Partitioning
 - determining if the option is enabled, 6-6
- password
 - changing the Management Repository password, 7-8
 - changing the SYSMAN password, 6-7

- PERFSTAT, 10-4
- PL/SQL procedures, 9-2, 9-10
 - sample, 9-12
 - while creating a notification method, 9-5
 - while creating notification methods, 9-4
- portlist.ini, 3-9
- ports
 - 4888, 3-5, 3-7
 - 4889, 3-5, 3-7, 7-8
 - changing the Management Agent port, 7-2
 - displaying in the Application Server Control, 3-10
 - portlist.ini, 3-9
 - reconfiguring the port used by the Management Service, 7-8
 - viewing a summary of ports assigned during installation, 3-9
- Preferred Credential Override
 - when migrating from previous versions of Enterprise Manager, 8-6
- proxy server
 - configuring Management Agent for, 3-3
 - configuring the Management Service for, 3-5
- proxyHost
 - property in emoms.properties, 3-6
- proxyPort
 - property in emoms.properties, 3-6
- Public Key Infrastructure (PKI), 2-5, 2-18, 2-28
- purging policies
 - See data retention policies

R

- RAID-capable disk
 - Management Repository guideline, 6-1
- redo logs
 - for Management Repository database, 6-1
- related documents, -xii
- RepManager script, 6-8, 6-9
- repo_mig
 - script for migrating from previous versions of Enterprise Manager, 8-7
- Repository already exists error
 - while configuring Database Control, 1-13
- Repository Operations Availability
 - default notification rule, 9-17
- REPOSITORY_PROXYHOST
 - property in emd.properties, 3-3
- REPOSITORY_PROXYPORT
 - property in emd.properties, 3-3
- REPOSITORY_URL
 - property in the emd.properties file, 7-2
- requirements
 - for migrating from previous versions of Enterprise Manager, 8-1
- rollover files, 5-2
- root password
 - See also SYSMAN
 - when enabling security for the Database Control, 2-19

- when enabling security for the Management Service, 2-7

root.sh

- when migrating from previous versions of Enterprise Manager, 8-7

S

screen readers, 1-26

Secure Upload Field

- on Management Agent home page, 2-10

security

- about Enterprise Manager security, 2-1
- Application Server Control, 2-17
- enabling for Database Control, 2-18
- overview of steps required to enable Enterprise Manager Framework Security, 2-6
- See also* Enterprise Manager Framework Security

security alert dialog box

- Internet Explorer, 2-25

security certificate alerts

- responding to, 2-25

security features

- See* Enterprise Manager Framework Security

Security Information dialog box

- Internet Explorer, 2-27

self-monitoring

- feature of the Management Agent, 7-4

Server Connection Hung

- error while creating the repository, 6-11

Services control panel

- using to start and stop the Management Agent, 1-15

session timeout

- modifying, 10-6

setupinfo.txt, 1-17

Single Sign-On

- bypassing the Single Sign-On logon page, 2-24
- configuring Enterprise Manager with, 2-20
- registering Enterprise Manager as a partner application, 2-23
- registering Single Sign-On users as Enterprise Manager administrators, 2-22
- using Single Sign-On to authorize Enterprise Manager users, 2-20

SNMP traps, 9-2, 9-4, 9-6

- sample, 9-7

SQL

- sample SQL for manually analyzing Management Repository tables, 6-6

SQLNET.CRYPTO_SEED

- entry in sqlnet.ora, 2-16, 2-17

SQLNET.ENCRYPTION_SERVER

- entry in sqlnet.ora, 2-16

sqlnet.ora, 2-14

- SQLNET.CRYPTO_SEED, 2-16, 2-17
- SQLNET.ENCRYPTION_SERVER, 2-16

starting and stopping

- Enterprise Manager components, 1-14

state directory

- in the Management Agent home, 7-2

Statspack, 10-3

SYSMAN

- changing the SYSMAN password, 6-7
- checking for existence of, 6-11
- entering SYSMAN password when enabling security, 2-7

sysman/admin/default_collection, 10-2

sysman/emd/collection, 10-2

T

target monitoring credentials

- defined, 1-22
- example of setting, 1-23
- setting, 1-22
- setting in Grid Control, 1-23

targets

- listing targets on a managed host, 1-23

tasks

- advanced configuration tasks, 1-1

Top SQL Report

- configuring the database to show the Top SQL Report, 10-3

trace files

- component tracing levels, 5-4
- controlling the content of, 5-4
- controlling the contents of Management Service, 5-8
- controlling the size and number of, 5-6
- controlling the size of, 5-3
- fetchlet trace files, 5-4
- locating Management Agent, 5-2
- locating Management Service, 5-6
- Management Agent, 5-1
- Oracle Management Service, 5-6
- rollover files, 5-2

tracing transactions, 4-5

Transaction Performance Monitoring

- advanced configuration, 4-4
- basic configuration, 4-4
- configuring, 4-2
- home page URL, 4-4
- overview of configuring, 4-3

transtrace application

- deploying to enable OC4J tracing, 4-15

TrcFileMaxRolls property in emd.properties, 5-3

TrcFileMaxSize property in emd.properties, 5-3

troubleshooting

- general techniques while creating the Management Repository, 6-11
- problems starting or configuring the Database Control, 1-13
- while creating the Management Repository, 6-10
- with EMCA, 1-13

U

UDP, 3-9

uix-config.xml, 1-27

- upload directory
 - in the Management Agent home, 7-2, 7-3
- UploadMaxBytesXML
 - property in the emd.properties file, 7-3
- UploadMaxDiskUsedPct
 - property in the emd.properties file, 7-4
- User Datagram Protocol, 3-9

W

- watchdog process
 - for the Management Agent, 7-4
- Web Application target
 - home page, 4-14
- Web Application Target Home Page, 4-2
- Web Applications
 - monitoring over HTTPS, 2-28
- Web Cache
 - See* Oracle Application Server Web Cache
- Web Cache Availability and Critical/Warning States
 - default notification rule, 9-14
- web.xml, 1-28

