

installation
guide

hp StorageWorks virtual arrays va 7000 family

Edition January 2003

Part number A6183-96143

Printed in U.S.A.



Notice

© Hewlett-Packard Company, 2000-2003. All rights reserved.

Hewlett-Packard Company makes no warranty of any kind with regard to this material, including, but not limited to, the implied warranties of merchantability and fitness for a particular purpose. Hewlett-Packard shall not be liable for errors contained herein or for incidental or consequential damages in connection with the furnishing, performance, or use of this material.

This document contains proprietary information, which is protected by copyright. No part of this document may be photocopied, reproduced, or translated into another language without the prior written consent of Hewlett-Packard. The information contained in this document is subject to change without notice.

Format Conventions

WARNING Identifies a hazard that can cause personal injury

Caution Identifies a hazard that can cause hardware or software damage

Note Identifies significant concepts or operating instructions

this font - used for all text to be typed verbatim: all commands, path names, file names, and directory names also, text displayed on the screen

<this font> - used for variables used in commands

this font - used for GUI menu options and screen controls

Trademark Information

Red Hat is a registered trademark of Red Hat Co.

C.A. UniCenter TNG is a registered trademark of Computer Associates International, Inc.

Microsoft, Windows NT, and Windows 2000 are registered trademarks of Microsoft Corporation

HP, HP-UX are a registered trademarks of Hewlett-Packard Company. Command View, Secure Manager, Business Copy, Auto Path are trademarks of Hewlett-Packard Company

Adobe and Acrobat are trademarks of Adobe Systems Inc.

Java and Java Virtual Machine are trademarks of Sun Microsystems Inc.

NetWare is a trademark of Novell, Inc.

AIX is a registered trademark of International Business Machines, Inc.

In This Guide

This guide is intended for use by information technology (IT), service, and other personnel involved in the installation of the HP StorageWorks Virtual Array products. It includes an installation flowchart, hardware tasks, and software tasks required for the successful installation of the product.

Revision History

September 2001

Change	Page
Added Quick Connect Guides to list of documents available during installation.	7
Clarified the valid range for loop ID is 0 -125	26
Added HP-UX 11.20 to the supported operating systems for Command View SDM	35
Changed disk enclosure numbering from 1-6 to 0-5.	31
Added information on identifying what array settings to change	24

January 2002

Change	Page
Added additional non-native supported operating systems.	35
Added additional host port behaviors	45

March 2002

Change	Page
Added SunCluster to supported host port behaviors.	45
Added step for changing array to RAID 1+0 if desired	26

April 2002

Change	Page
Added step for setting FC Loop Speed switch on DS 2405	16
Added hardware problem solutions for DS 2405 installations.	48

July 2002

Change	Page
Added note on connecting only CVSDM hosts to the array until LUN security is enabled.	27
Added VA 7410 back-end Fibre Channel cabling	29
Removed Compaq Tru64 and Compaq OpenVMS from supported non-native operating systems.	35
Added note on using the CVSDM GUI to create the host port behavior table. Also added maximum number of table entries.	45
Add Step 22 to connect all hosts to the array after LUNs have been created and LUN security implemented.	47

January 2003

Change	Page
Added VA 7110.	Multiple

1 Virtual Array Installation Guide 7

Other Information You Will Need	7
Operating Environment	8
Virtual Array Configurations	8
Virtual Array Enclosures	8
Hardware Installation	15
Step 1. Unpack the array	15
Step 2. Rack the array	15
Step 3. Set FC Loop Speed Switch (VA 7400 with DS 2405 Disk System)	16
Step 4. Connect the power cords	19
Step 5. Connect the RS-232 terminal	20
Step 6. Power-on the array controller enclosure	22
Configuring the Array Operating Settings	24
Step 7. Change the controller default host port behavior	25
Step 8. Change the controller port data rate to 2 Gbit/sec	25
Step 9. Change the controller port topology	26
Step 10. Change the controller loop ID	26
Step 11. Change the RAID operating level of the array	26
Step 12. Format the array controller enclosure	27
Step 13. Power-off the array controller enclosure	27
Step 14. Disconnect the RS-232 terminal	27
Step 15. Connect fiber optic cables	27
Step 16. Power-on all array enclosures	34
Installing CommandView SDM Software	35
Step 17. Install CommandView SDM software	35
Installing Command View SDM on HP-UX	37
Minimum System Requirements for HP-UX	37
Installation Steps	38
Installing Command View SDM on Windows	40

Minimum System Requirements for Windows arrays	40
Installation Steps	40
Installing Command View SDM on Linux Red Hat	42
Minimum System Requirements for Linux Red Hat	42
Installation Steps	43
Final Array Configuration	44
Step 18. Gather Host WWNs	44
Step 19. Build the Host Port Behavior Table	45
Step 20. Create LUNs	46
Step 21. Build the Secure Manager LUN Security Table	47
Step 22. Connect All Hosts to the Array	47
Installation of the virtual array is now complete!	47
Solving Installation Problems	48
Hardware Problems	48
Software Problems	49

Virtual Array Installation Guide

This guide provides instructions on installing the hardware and software components for the HP StorageWorks Virtual Array products. When the steps in this guide are completed, the virtual array will be fully operational and ready for use.

Other Information You Will Need

In addition to this guide, you should have the following documents and information available:

- *HP StorageWorks Virtual Array Family Rack Installation Guide* - includes instructions for installing the array into the supported computer racks.
- *HP StorageWorks Virtual Array User & Service Guide* - includes step-by-step instructions for operating, servicing, and upgrading the array.
- *HP StorageWorks CommandView SDM Installation and User Guide* - describes how to install and use the CommandView SDM software to manage your array.
- *HP StorageWorks Secure Manager Virtual Array Installation and User Guide* - describes how to use the Secure Manager feature of the array to implement LUN security.
- *Quick Connect Guide(s) and Connectivity Streams Documents* - these documents provide detailed, operating system-specific configuration and installation information. They are particularly valuable when installing on a non-native operating system. These guides can be downloaded from the following internal HP web site:

<http://hps0.rose.hp.com/spock/#NASL>

Operating Environment

It is essential that HP StorageWorks Virtual Array products be installed in an environment that provides the proper operating conditions. Refer to the *HP StorageWorks Virtual Array User & Service Guide* for a complete list of electrical and environmental specifications. Make sure the environment meets these specifications before installing and operating the array.

Virtual Array Configurations

Enclosure Nameplate	Type of Enclosure	No. of Enclosures in VA 7100	No. of Enclosures in VA 7110	No. of Enclosures in VA 7400/7410
Virtual Array	Controller	1	1	1
Disk System 2400 Disk System 2405	Disk	0	0 to 2	0 to 6

Virtual Array Enclosures

Figure 1 through Figure 4 show the enclosures and their associated controls, indicators, and connectors.

Figure 1 VA 7100 Controller Enclosure (A/AZ)

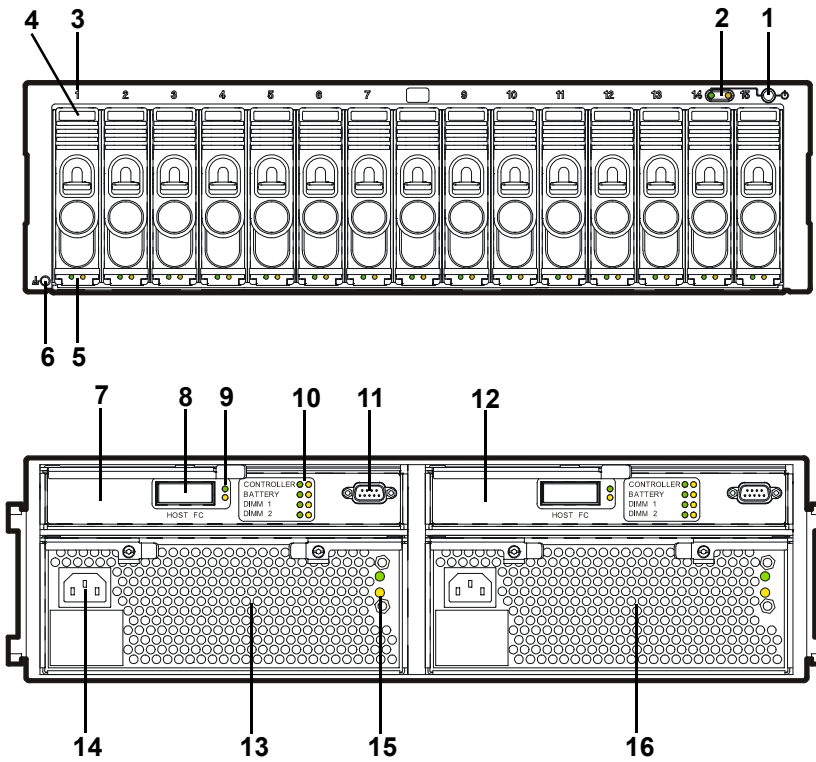

- 1 - Power/Standby Switch
- 2 - System LEDs
- 3 - Disk Drive Slot No. 1 (of 15)
- 4 - Disk Drive 1 (of 15)
- 5 - Disk Drive LEDs
- 6 - ESD Ground Receptacle
- 7 - Array Controller Card 1
- 8 - HOST FC Connector

- 9 - HOST FC LEDs
- 10 - Array Controller LEDs
- 11 - RS-232 Connector
- 12 - Array Controller Card 2
- 13 - Power Module 1
- 14 - AC Power Connector
- 15 - Power Module LEDs
- 16 - Power Module 2

Figure 2 VA 7100 Controller Enclosure (D)

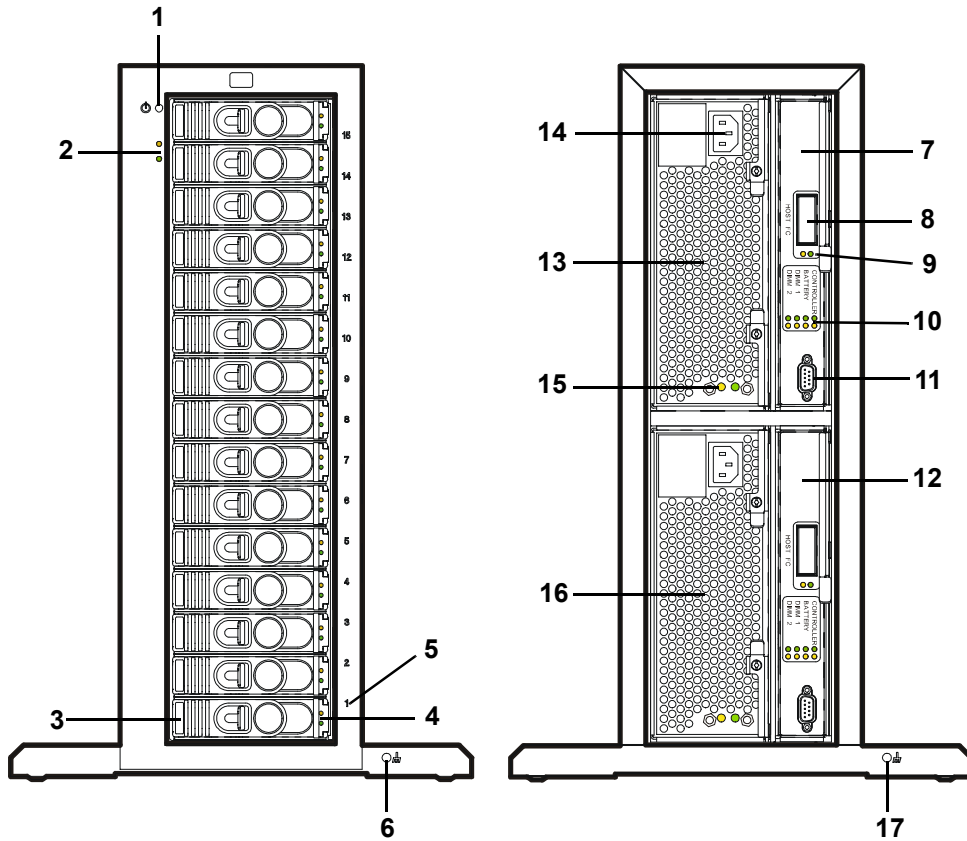

- 1 - Power/Standby Switch
- 2 - System LEDs
- 3 - Disk Drive 1 (of 15)
- 4 - Disk Drive LEDs
- 5 - Disk Drive Slot No. 1 (of 15)
- 6 - Front ESD Ground Receptacle

- 7 - Array Controller Card 1
- 8 - HOST FC Connector
- 9 - HOST FC LEDs
- 10 - Array Controller LEDs
- 11 - RS-232 Connector
- 12 - Array Controller Card 2
- 13 - AC Power Connector
- 14 - Power Module 1
- 15 - Power Module LEDs
- 16 - Power Module 2
- 17 - Rear ESD Ground Receptacle

Figure 3 VA 7110 Controller Enclosure

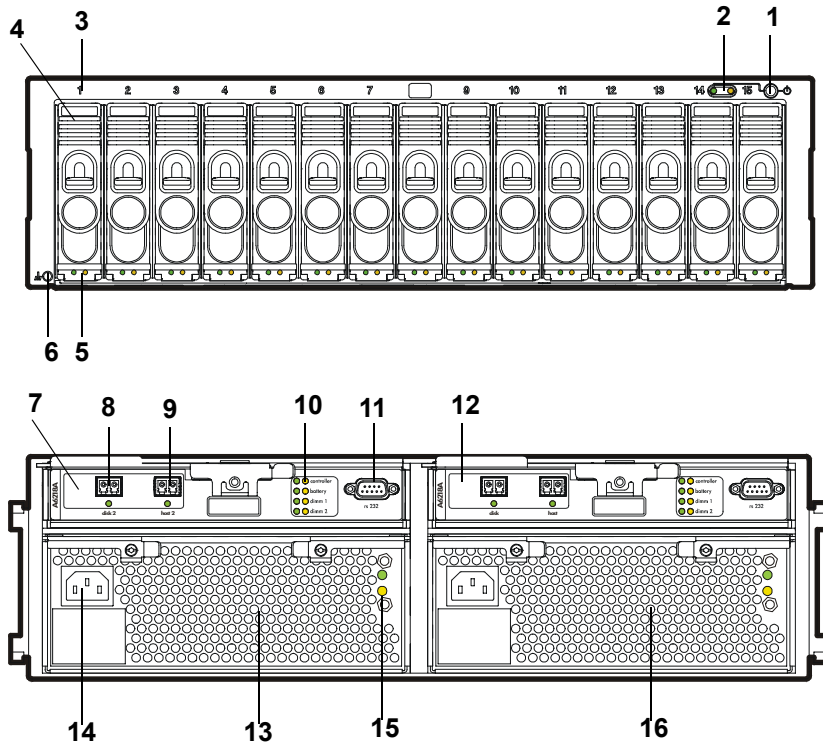

- | | |
|--|----------------------------------|
| 1 - Power/Standby Switch | 9 - HOST FC Connector - M/C1.H1* |
| 2 - System LEDs | 10 - Array Controller LEDs |
| 3 - Disk Drive Slot No. 1 (of 15) | 11 - RS-232 Connector |
| 4 - Disk Drive 1 (of 15) - M/D1* | 12 - Array Controller 2 - M/C2* |
| 5 - Disk Drive LEDs | 13 - Power Module 1 - M/P1* |
| 6 - ESD Ground Receptacle | 14 - AC Power Connector |
| 7 - Array Controller 1 - M/C1* | 15 - Power Module LEDs |
| 8 - DISK FC Connector and LED - M/C1.G1* | 16 - Power Module 2 - M/P2* |

*Reference designator used in CommandView SDM

Figure 4 VA 7400 Controller Enclosure (A/AZ)

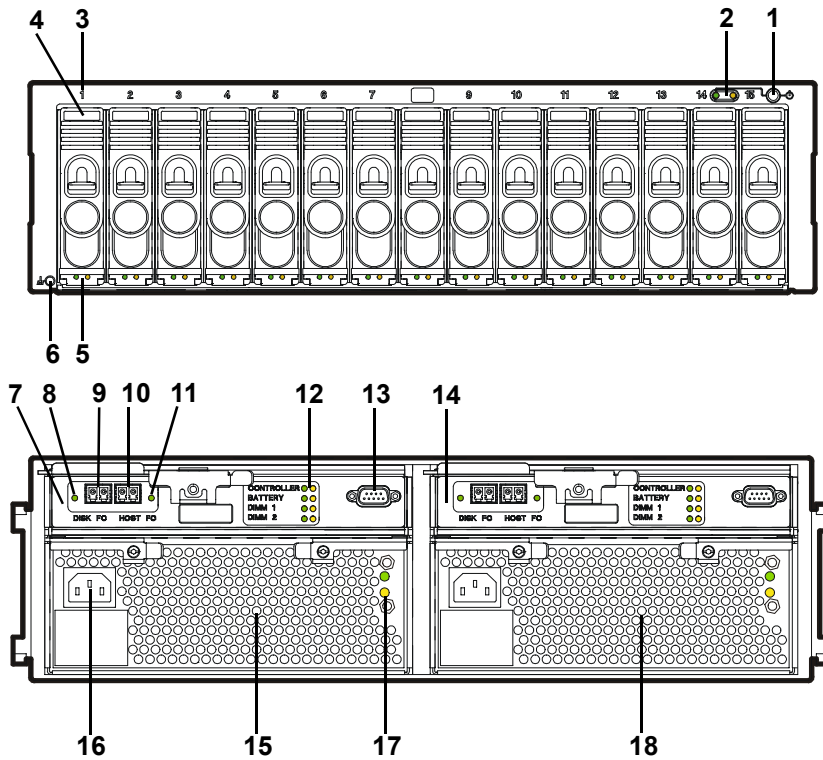

- | | |
|-----------------------------------|------------------------------|
| 1 - Power/Standby Switch | 10 - HOST FC Connector |
| 2 - System LEDs | 11 - HOST FC LED |
| 3 - Disk Drive Slot No. 1 (of 15) | 12 - Array Controller LEDs |
| 4 - Disk Drive 1 (of 15) | 13 - RS-232 Connector |
| 5 - Disk Drive LEDs | 14 - Array Controller Card 2 |
| 6 - ESD Ground Receptacle | 15 - Power Module 1 |
| 7 - Array Controller Card 1 | 16 - AC Power Connector |
| 8 - DISK FC LED | 17 - Power Module LEDs |
| 9 - DISK FC Connector | 18 - Power Module 2 |

Figure 5 VA 7410 Controller Enclosure (A/AZ)

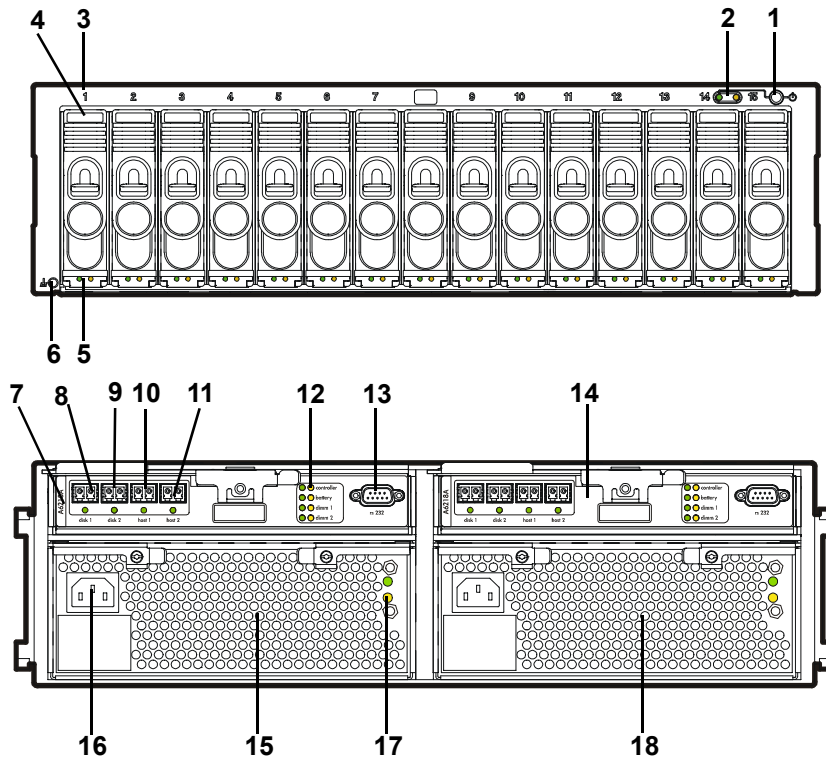

- | | |
|-----------------------------------|------------------------------|
| 1 - Power/Standby Switch | 10 - HOST 1 FC Port and LED |
| 2 - System LEDs | 11 - HOST 2 FC Port and LED |
| 3 - Disk Drive Slot No. 1 (of 15) | 12 - Array Controller LEDs |
| 4 - Disk Drive 1 (of 15) | 13 - RS-232 Connector |
| 5 - Disk Drive LEDs | 14 - Array Controller Card 2 |
| 6 - ESD Ground Receptacle | 15 - Power Module 1 |
| 7 - Array Controller Card 1 | 16 - AC Power Connector |
| 8 - DISK 1 FC Port and LED | 17 - Power Module LEDs |
| 9 - DISK 2 FC Port and LED | 18 - Power Module 2 |

Figure 6 VA 7110/7400/7410 Disk Enclosure (A/AZ)

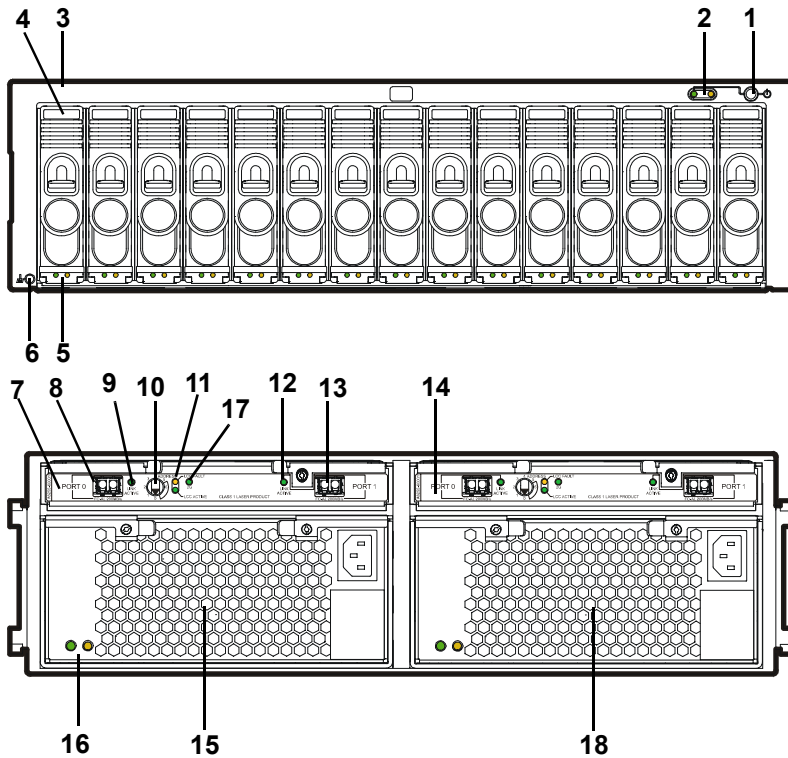

- | | |
|-----------------------------------|--|
| 1 - Power/Standby Switch | 10 - ADDRESS Switch |
| 2 - System LEDs | 11 - LCC LEDs |
| 3 - Disk Drive Slot No. 1 (of 15) | 12 - PORT 1 LINK ACTIVE LED |
| 4 - Disk Drive 1 (of 15) | 13 - PORT 1 FC-AL Connector |
| 5 - Disk Drive LEDs | 14 - Link Controller Card 2 |
| 6 - ESD Ground Receptacle | 15 - Power Module 1 |
| 7 - Link Controller Card 1 | 16 - Power Module LEDs |
| 8 - PORT 0 FC-AL Connector | 17 - 2G LED (DS 2405 Disk System only) |
| 9 - PORT 0 LINK ACTIVE LED | 18 - Power Module 2 |

Note

The DS 2400 Disk System and the DS 2405 Disk System are both used on the VA 7400. The products are identical with the exception of the 2G LED included on the DS 2405.

Hardware Installation

Step 1. Unpack the array

- 1 Follow the unpacking instructions printed on the shipping container to unpack the controller enclosure.
- 2 Follow the unpacking instructions printed on the shipping container to unpack any disk enclosures (VA 7110/7400/7410 only).

Step 2. Rack the array

WARNING To prevent the rack from tipping over, install the enclosures to maintain the center of gravity as low as possible.

A full enclosure may weigh up to 104 pounds (47 kg). To avoid serious injury, use a mechanical lift, or remove all disk modules and power modules before lifting an enclosure into the rack. Refer to “Servicing and Upgrading” in the *HP StorageWorks Virtual Array User & Service Guide*.

To install enclosures into supported racks, refer to the appropriate instructions for your rack in the *HP StorageWorks Virtual Array Family Rack Installation Guide*. [Table 1](#) shows the supported racks for the virtual arrays.

Table 1 Virtual Array Supported Racks

Rack Product No.	Rack Name	Height meters (EIA Units)	EIA Units Per Encl. ¹	Enclosures Per Rack ²
J1500A	HP Rack System/E41	1.96 m (41 U)	3	13
J1501A	HP Rack System/E33	1.60 m (33 U)	3	11
J1502A	HP Rack System/E25	1.25 m (25 U)	3	8
C2785A	HP Computer Cabinet	1.10 m (21 U)	4	5
C2786A	HP Computer Cabinet	1.60 m (32 U)	4	8
C2787A	HP Computer Cabinet	1.96 m (41 U)	4	10
9142	Compaq 9000 Rack	2.0 m (42 U)	3	14
9136	Compaq 9000 Rack	1.7 m (36 U)	3	12
9122	Compaq 9000 Rack	1.1 m (22 U)	3	7

¹HP Computer Cabinet requires a 1U filler panel to hide the mounting rails.

²Does not include space that may be required for PDUs.

Step 3. Set FC Loop Speed Switch (VA 7400 with DS 2405 Disk System)

When installing a VA 7400 that includes DS 2405 Disk Systems, the FC Loop Speed switch on the disk enclosure LCCs must be set to 1GB/s. Failure to set the switch on both LCCs in each disk enclosure will disrupt the FC loop and cause the entire array to malfunction.

Note This step is not required when installing a VA 7410 or VA 7110. These products have a 2 Gbit/sec back-end, which is the default FC Loop Speed switch setting on the DS 2405.

- 1 Attach an ESD strap to ground.
- 2 Remove the LCC from the disk enclosure. See [Figure 7](#).
 - a Loosen the locking thumbscrews on the LCC.
 - b Pull out on the controller cam latches to remove the LCC.
- 3 Set the configuration dip switch to 1GB/s link speed. See [Figure 8](#).
- 4 Reinstall the LCC in the disk enclosure.
 - a Open the controller cam latches by pulling them away from the center.
 - b Slide the LCC into the enclosure until it meets the backplane.
 - c Press the cam latches inward and flat against the center.
 - d Tighten the locking thumbscrews .
- 5 Repeat for both LCCs in every disk enclosure.

Figure 7 LCC Removal and Installation

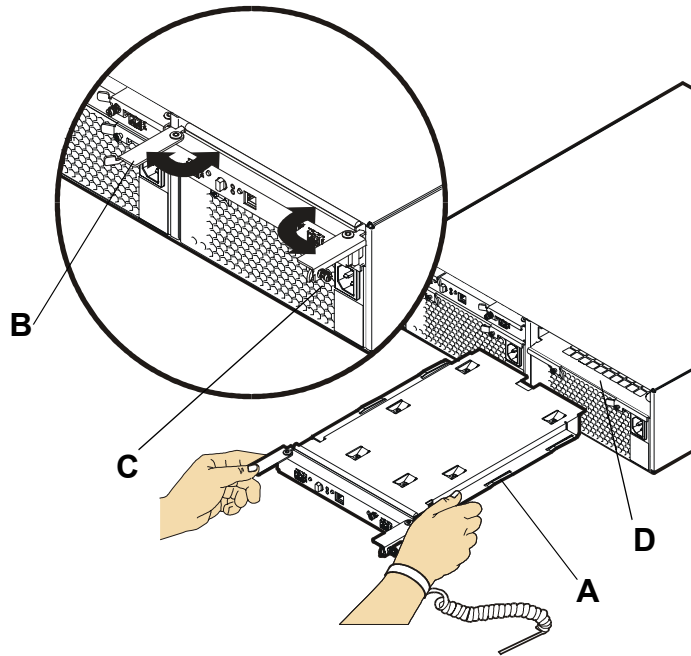

- | | |
|-------------|----------------------|
| A LCC | C locking thumbscrew |
| B cam latch | D LCC slot |

Figure 8 Setting FC Loop Speed Switch

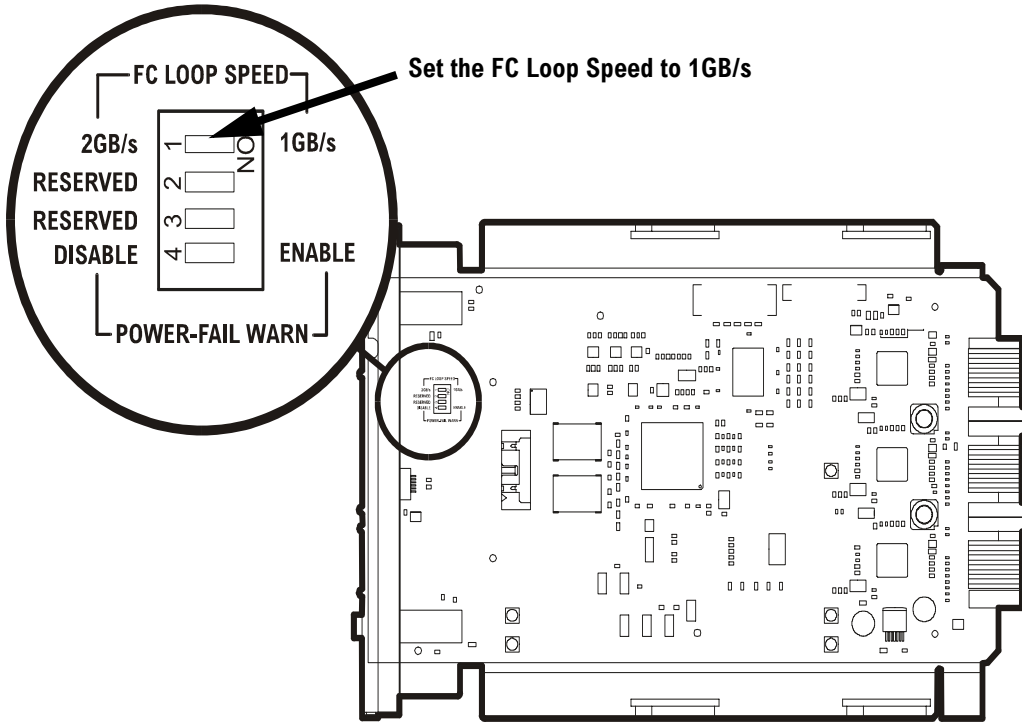

Step 4. Connect the power cords

WARNING To avoid electrical fire hazard, use a branch circuit breaker properly rated for each power supply. If multiple enclosures are connected to a single branch circuit, multiply the number of enclosures times the maximum current, then select a circuit breaker with at least a 20% higher current rating. See [Table 2](#).

To optimize system availability, each power supply should be connected to a separate power bus. All wiring should meet or exceed local electrical wiring codes.

The product power cords are used as main disconnect devices. To ensure that the power cords can be disconnected quickly, locate the product near an easily accessible power outlet.

Table 2 Enclosure Electrical Specifications

Controller Enclosure	Disk Enclosure
685 Volt-Amps	500 Volt-Amps
2288 BTU/Hour	1611 BTU/Hour

- 1 Connect the male ends of the power cords to one of the following ac power outlets:
 - Separate ac circuits.
 - Separate uninterruptible power supplies (UPSs).
 - For racked enclosures, separate power distribution units (PDUs).
- 2 Connect the female ends of the power cords to the ac power connectors on controller enclosures and disk enclosures. See [Figure 9](#).

Note Make sure that the locations of power cables do not interfere with the removal of field replaceable units.

Figure 9 Connecting Enclosure Power Cords

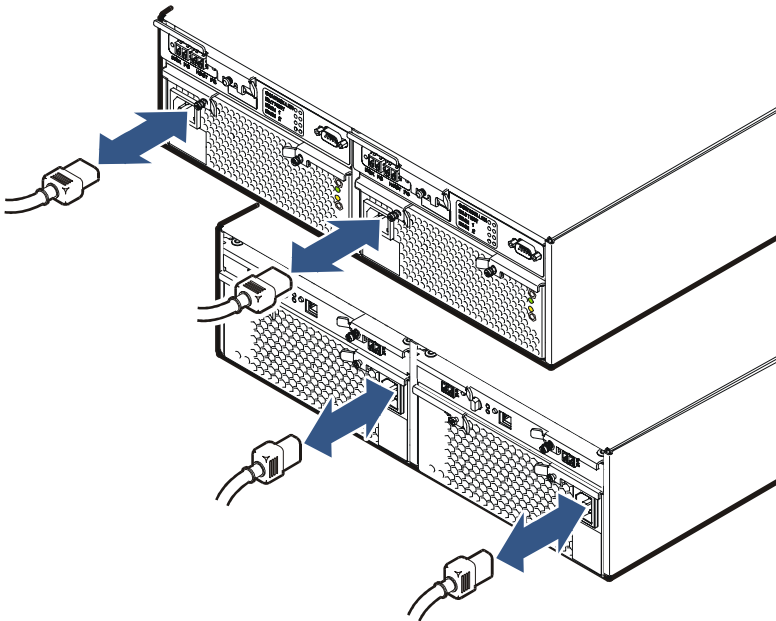

Caution If it becomes necessary to completely remove power from the array, you must unplug both power cords from both ac power connectors on the array rear panel.

Step 5. Connect the RS-232 terminal

- 1 Connect one end of the null-modem serial cable to the RS-232 port on either array controller. See [Figure 10](#).

Note The RS-232 port on either array controller can communicate with both controllers.

- 2 Connect the other end of the null-modem serial cable to the RS-232 port on a laptop PC, desktop PC, or any RS-232 terminal.
- 3 Power-on the PC.

- 4 Start a terminal emulator using *HyperTerminal* or *Reflections*. Use the following settings:
 - Bits per second: 9600
 - Data bits: 8
 - Parity: None
 - Stop bits: 1
 - Flow control: None

Figure 10 Connecting the Null-Modem Serial Cable

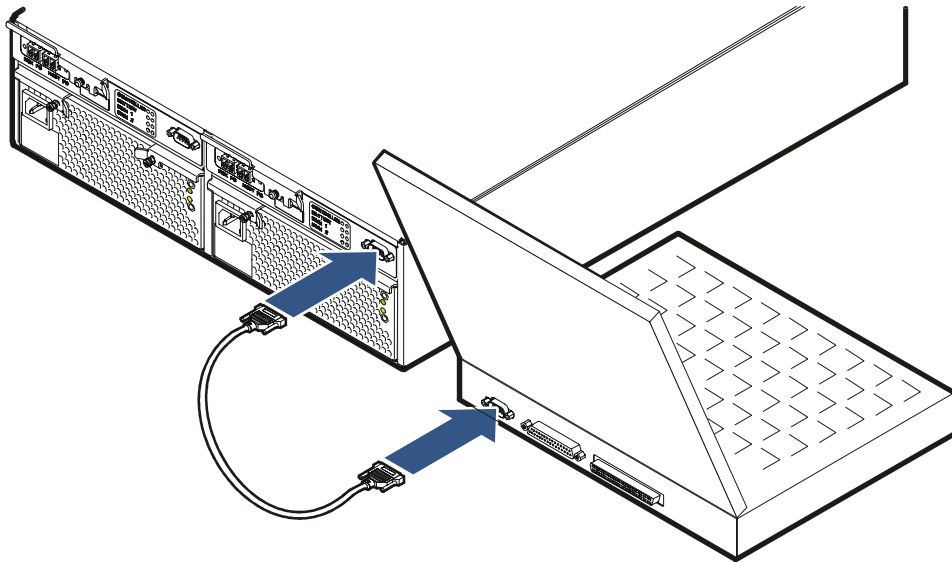

Step 6. Power-on the array controller enclosure

- a Push in the power/standby switch to the “ON” position. See Figure 11. Immediately after the array is powered on, each component in the array enclosure performs a power-on self-test.
- b Verify the power-on self-test passed: all LEDs should be solid green.

During power-on self-test, the an initialization sequence is displayed followed by the Ready prompt.

If the array does not display a Ready status, see ["Solving Installation Problems"](#) on page 48 for help in solving the problem.

Figure 11 Operating the Power/Standby Switch

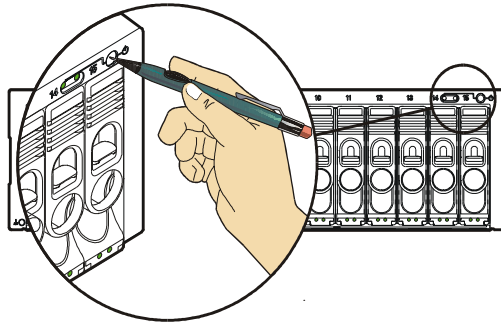

Disk Sector Reformatting

If the disks in the array controller enclosure are formatted with 512-byte sectors, they are reformatted to 520-byte sectors at this time. Sector reformatting takes 30 to 60 minutes to complete, depending on disk drive capacity. Larger capacity disks take longer to reformat. If the disks have 520-byte sectors, this process is not performed.

The disk activity LEDs will flash during sector reformatting. When all disk lights are stable, the reformatting process is complete, and the installation can continue.

Caution Do not proceed with the installation of the array until the reformatting is complete.

To prevent format corruption, do not remove disk drives or power-off the array during the reformatting sequence. If a disk drive is removed or the array is powered off, the array will detect a corrupt format, re-issue the Format command, and re-start the formatting process.

The status of the disk can be checked using the virtual front panel `dsp -d` command. If a disk fails during the format operation, the amber Disk Fault LED will be on.

Configuring the Array Operating Settings

There are several settings that control the operation of the array. The values selected for these settings are determined by the operating environment.

The various settings and when they need to be changed are listed in the following table. Identify the settings that need to be changed and perform the required steps.

Note To view the current array settings, type `vfpdsp -s`

Setting	Default	When to change
Host port behavior	HP-UX	If the host(s) connected to the array are running an operating system other than HP-UX. Also, if the CommandView SDM management host is not an HP-UX host.
Port data rate* (VA 7400/7410 and VA 7110 only)	1 Gbit/sec	If the array will be connected to a host/switch with a 2 Gbit/sec data rate
Port topology*	Private Loop	If the array will be operating in a Public Loop or Direct Fabric Attach topology
Controller Loop ID*	Controller 1: 108 Controller 2: 110	If the default settings conflict with any other devices on the loop
RAID operating level	AutoRAID	If there is a need to operate the entire array in RAID 1+0 mode.

* Changing any of these settings requires that the array be reset before the new setting is used. Only one reset is required to invoke all new settings, so change all the necessary settings and then reset the array.

Step 7. Change the controller default host port behavior

Note It is recommended that the default controller port behavior be set for the operating system of the host running *CommandView SDM*. This ensures that the management station will still function if the host port behavior table in the array is corrupted or lost.

- 1 To change the host port behavior for Controller 1 enter the following command, selecting the appropriate behavior value:

```
mgr -os <nt|win2k|linux|solaris|aix|netWare|MPE|
SunCluster> -c 1
```

- 2 To change the host port behavior for Controller 2, enter the following command, selecting the appropriate behavior value:

```
mgr -os <nt|win2k|linux|solaris|aix|netware|MPE|
SunCluster> -c 2
```

To view the current host port behavior setting for controller 1 or controller 2, enter the following commands:

```
dsp -c 1
dsp -c 2
```

Step 8. Change the controller port data rate to 2 Gbit/sec (VA 7110/7400/7410 Only)

- 1 To change the port data rate to 2 Gbit/sec for controller 1, enter:

```
mgr -S 2 -c 1
```

- 2 When prompted to reset, enter `no`.

- 3 To change the port data rate for controller 2, enter:

```
mgr -S 2 -c 2
```

- 4 When prompted to reset, enter `no` if additional settings must be changed. If all changes have been made, enter `yes` to reset the array.

Step 9. Change the controller port topology

- 1 To change the port topology for controller 1 enter the following command, selecting **2** for Public Loop or **4** for Direct Fabric Attach:

```
mgr -t < 2 | 4 > -c 1
```

- 2 When prompted to reset, enter `no`.
- 3 To change the port topology for controller 2 enter the following command, using the same topology value used for controller 1:

```
mgr -t < 2 | 4 > -c 2
```

- 4 When prompted to reset, enter `no` if additional settings must be changed. If all changes have been made, enter `yes` to reset the array.

Step 10. Change the controller loop ID

- 1 To change the loop ID for Controller 1, enter:

```
mgr -L loop_ID -c 1
```

where *loop_ID* is a value from 1 to 125

- 2 When prompted to reset, enter `no`.
- 3 To change the loop ID for Controller 2, enter:

```
mgr -L loop_ID -c 2
```

- 4 When prompted to reset, enter `no` if additional settings must be changed. If all changes have been made, enter `yes` to reset the array.

Step 11. Change the RAID operating level of the array

If the customer wants to operate the array in RAID 1+0 mode rather than AutoRAID, change the level as follows:

- 1 To change the RAID level to RAID 1+0, enter:

```
mgr -B raid1
```

- 2 When prompted to reset, enter `yes` to reset the array.

Step 12. Format the array controller enclosure

Formatting the array controller enclosure performs the following operations:

- Places identifying drive stamps on each drive in the array.
 - Reserves image disks in the controller enclosure.
 - Deletes all LUNs.
 - Initializes the memory maps.
 - Creates pseudo-LUN 0 allocated with zero bytes so the host will recognize the array.
- To format the array, enter the following command:

```
vfpfmt
```

Step 13. Power-off the array controller enclosure

- Push in the power/standby switch then release it to the standby position. See [Figure 11](#).

Note The system power/activity LED will turn off when the power/standby switch is set to the standby position.

Step 14. Disconnect the RS-232 terminal

- 1 Power-off the RS-232 terminal.
- 2 Remove the null-modem cable from the array controller.
- 3 Remove the null-modem cable from the RS-232 terminal.

Step 15. Connect fiber optic cables

Note In multi-host environments, it is recommended that the array be initially connected only to the host(s) that will be running CommandView SDM. After the array is fully configured, including LUN security, the remaining hosts can be added. This will avoid the situation of a host initially seeing LUNs that disappear after LUN security is enabled.

Connecting front-end fiber optic cables

Connect front-end fiber optic cables to the HOST FC connectors on the array controllers and to the host adapter, hub, or switch.

Front-end fiber optic connections depend on the type of connectors used by the controller and the type of host adapter or type of connector in the hub or switch.

- The VA 7100 controller uses GBICs with SC (large form factor) connectors. It only supports host adapters with SC connectors, and uses cables with SC-SC connectors.
- The VA 7110/7400/7410 controller uses integrated LC (small form factor) connectors. It supports host adapters with LC connectors, using LC-LC cables, or host adapters with SC connectors, using LC-SC adapter cables with couplers.

See [Figure 15](#) for information on supported fiber optic cables and configurations.

Connecting back-end fiber optic cables and setting address switches (VA 7110/7400/7410 Only)

The VA 7400/7410 supports up to 6 external disk enclosures and the VA 7110 supports up to 2 disk enclosures. It is recommended that the back-end connections be made using the shortest possible FC cables.

VA 7400 and VA 7110

Refer to [Figure 12](#) when connecting disk enclosures to a VA 7110, and [Figure 13](#) when connecting disk enclosures to a VA 7400. Up to 2 disk enclosures can be connected to an VA 7110, and up to 6 disk enclosures can be connected to a VA 7400.

- 1 Connect a back-end fiber optic cable from the DISK FC connector on array controller 1 to the PORT 0 or PORT 1 FC-AL connector on the closest disk enclosure.
- 2 Connect a back-end fiber optic cable from the DISK FC connector on array controller 2 to the PORT 0 or PORT 1 FC-AL connector on the same disk enclosure.
- 3 Connect all disk enclosures together by connecting fiber optic cables between the PORT 0 and PORT 1 FC-AL connectors on the enclosures.
- 4 Set the address switches on the disk enclosures. See [Figure 13](#). Each disk enclosure must have a unique address. Both link controller cards in the enclosure must be set to the same address.

Note It is recommended that you set the disk enclosure addresses starting with 0 and incrementing by 1 for each enclosure.

VA 7410

The VA 7410 has two independent back-end Fibre Channel loops to improve performance. The cabling configuration should balance the distribution of disk modules across both loops. Here are some things to remember when connecting the VA 7410 back-end cabling:

- All disks in the controller enclosure are connected to loop 1.
- The first disk enclosure should be connected to loop 2 to balance the disks.
- Additional disk enclosures should be alternated between loops to balance the number disks on each loop. The number of disk enclosures on loop 1 should be equal to or one less than the number of enclosures on loop 2.
- Do not connect a disk enclosure to both loops.

Refer to [Figure 14](#) when connecting disk enclosures to the VA 7410.

- 1 Determine which disk enclosures will be on loop 1 and which will be on loop 2.
- 2 Connect loop 1 disk enclosures as follows.
 - a Connect a back-end fiber optic cable from the DISK 1 FC port on array controller 1 to the PORT 0 or PORT 1 FC connector on the closest disk enclosure on loop 1.
 - b Connect a back-end fiber optic cable from the DISK 1 FC port on array controller 2 to the PORT 0 or PORT 1 FC connector on the same disk enclosure on loop 1.
 - c Connect all loop 1 disk enclosures together by connecting fiber optic cables between the PORT 0 and PORT 1 FC connectors on the enclosures.
- 3 Connect loop 2 disk enclosures as follows.
 - a Connect a back-end fiber optic cable from the DISK 2 FC port on array controller 1 to the PORT 0 or PORT 1 FC connector on the closest disk enclosure on loop 2.
 - b Connect a back-end fiber optic cable from the DISK 2 FC port on array controller 2 to the PORT 0 or PORT 1 FC connector on the same disk enclosure on loop 2.
 - c Connect all loop 2 disk enclosures together by connecting fiber optic cables between the PORT 0 and PORT 1 FC connectors on the enclosures.

- 4 Set the address switches on the disk enclosures. See [Figure 14](#). Each disk enclosure should have a unique address. Both link controller cards in the enclosure must be set to the same address.

Note For ease of management, it is recommended that odd addresses (1, 3, 5) be used for disk enclosures on loop 1 and even addresses (0, 2, 4) be used for disk enclosures on loop 2. Because the two back-end FC loops are independent, disk enclosures on different loops can have the same address.

Figure 12 VA 7110 Back-End Fiber Optic Cabling & Addressing (2 Disk Enclosures)

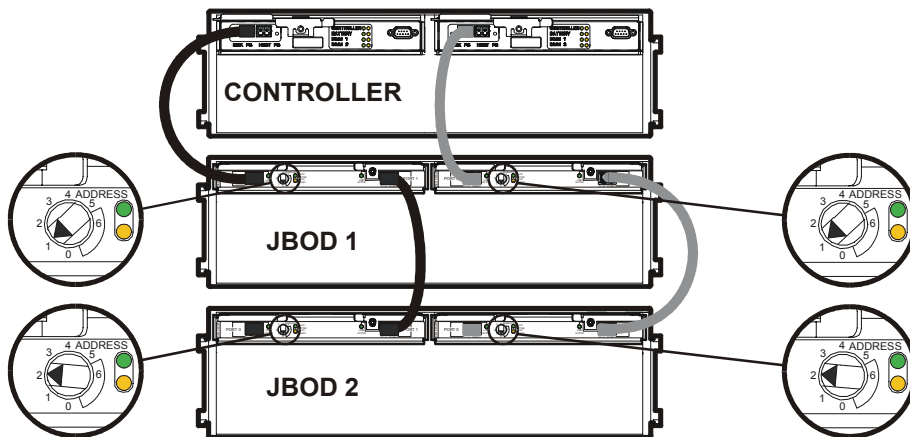

Figure 13 VA 7400 Back-End Fiber Optic Cabling & Addressing (6 Disk Enclosures)

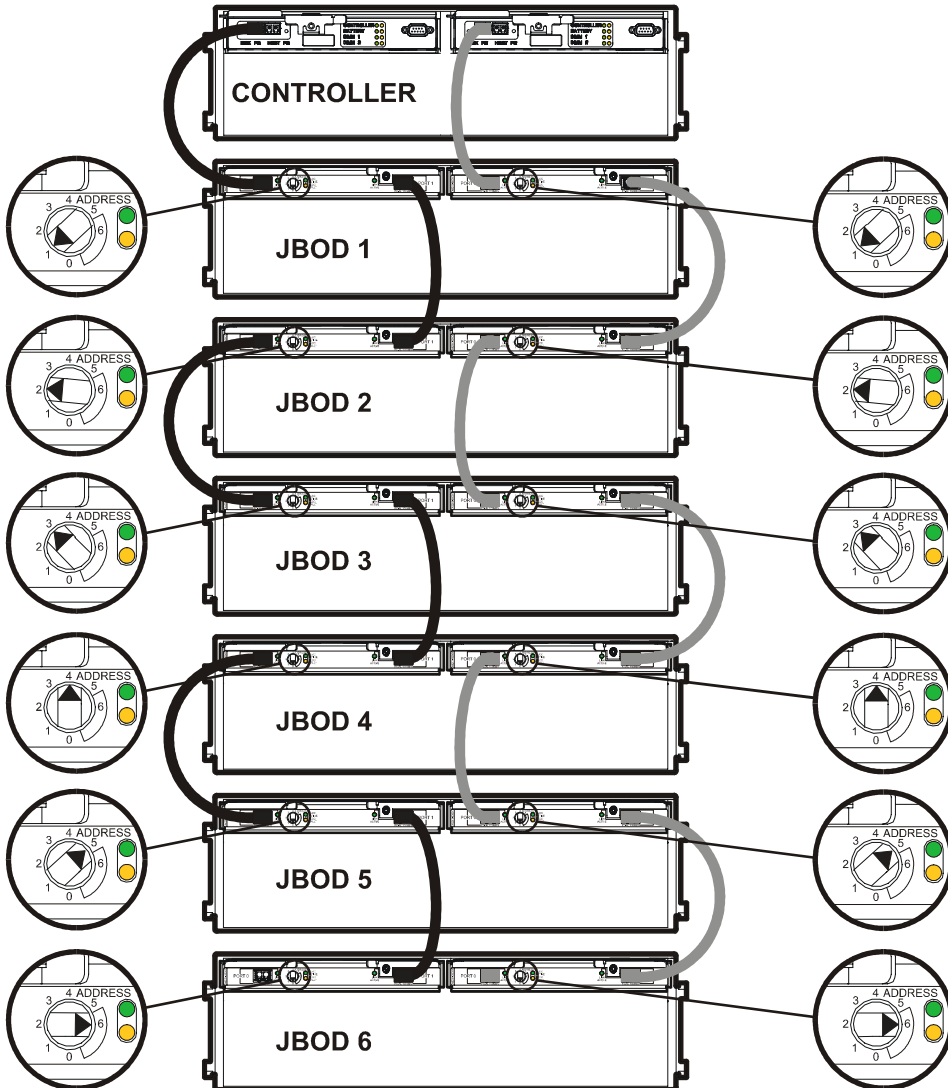

Figure 14 VA 7410 Back-End Fiber Optic Cabling & Addressing (6 Disk Enclosures)

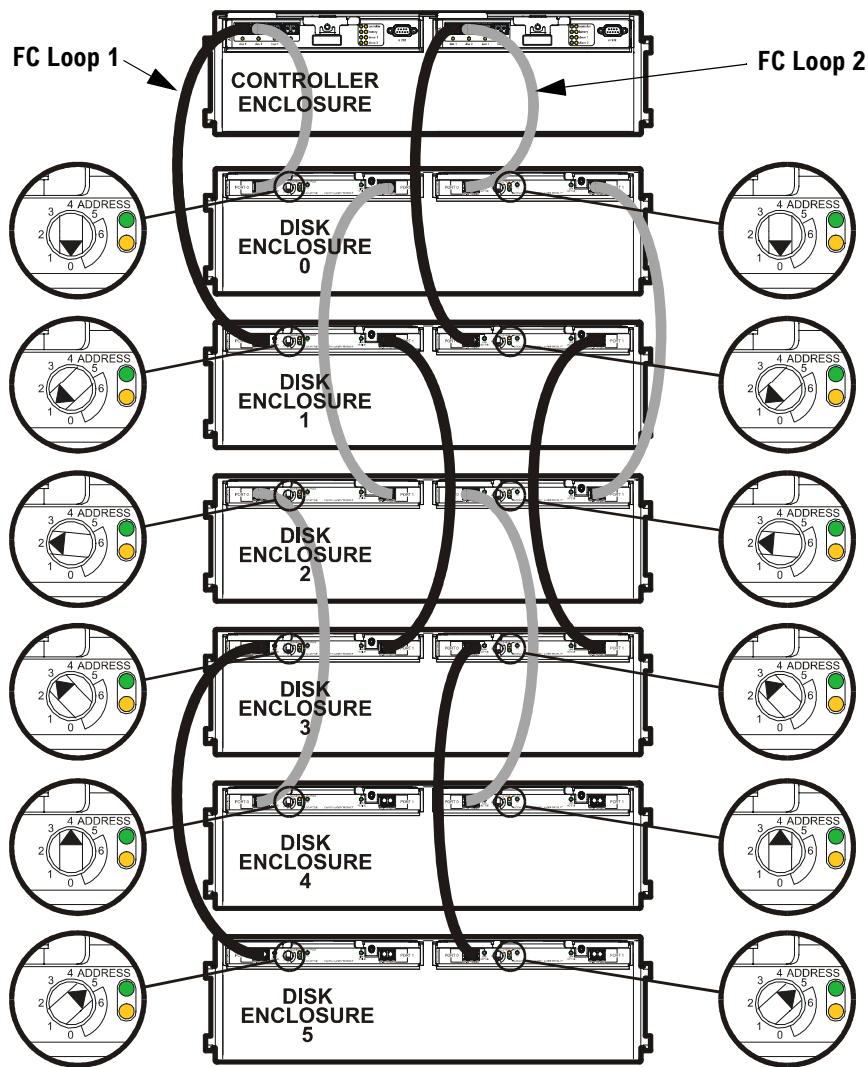
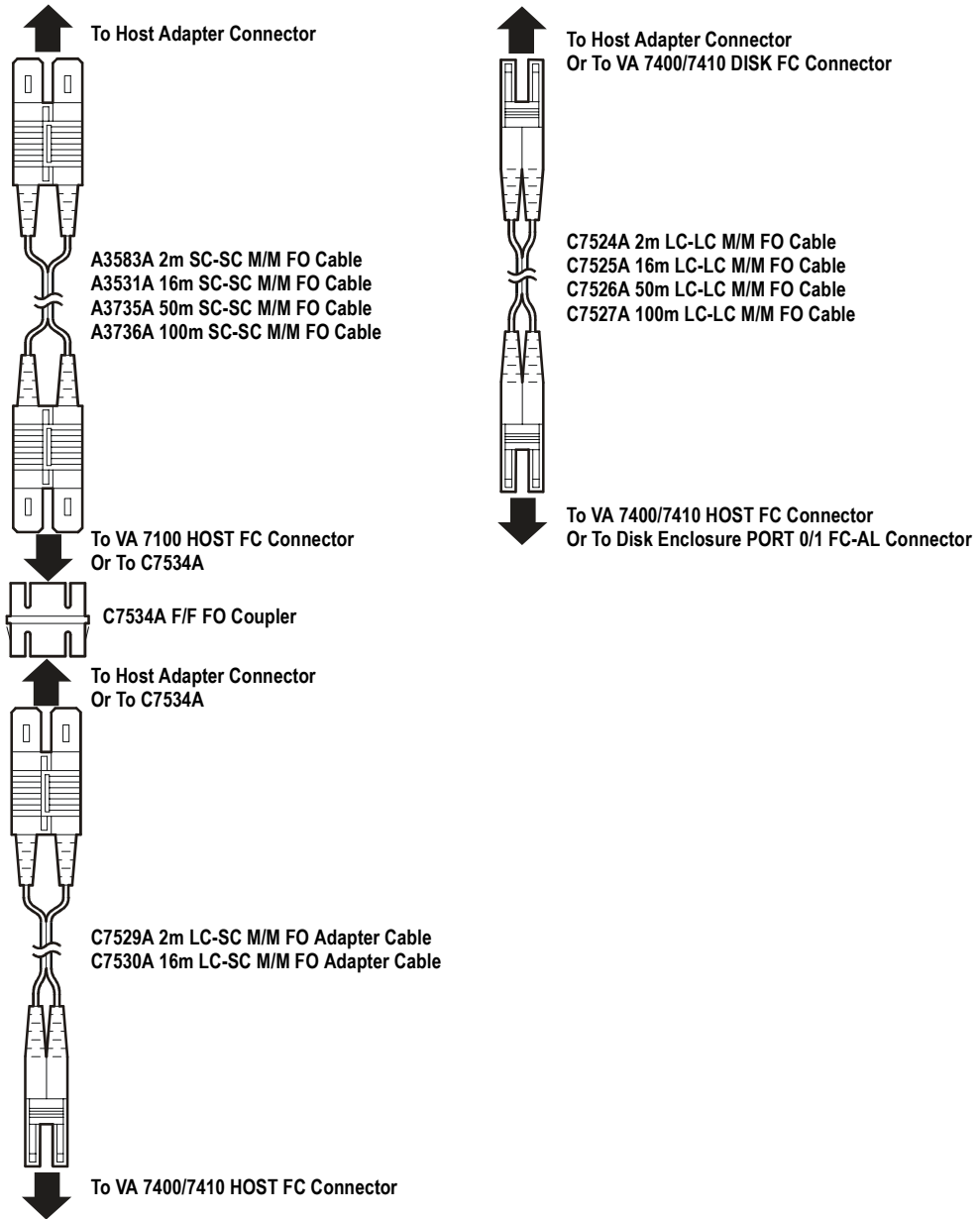

Figure 15 Fiber Optic Cables & Configurations



Step 16. Power-on all array enclosures

- 1 Power-on the disk enclosures.
- 2 Power-on the controller enclosure.

Disk Sector Reformatting

If the disks in the disk enclosures are formatted with 512-byte sectors, they are reformatted to 520-byte sectors at this time. Sector reformatting takes 30 to 60 minutes to complete, depending on disk drive capacity. Larger capacity disks take longer to reformat. If the disks have 520-byte sectors, this process is not performed.

The disk activity LEDs will flash during sector reformatting. When all disk lights are stable, the reformatting process is complete, and the installation can continue.

Caution Do not proceed with the installation of the array until the reformatting is complete.

To prevent format corruption, do not remove disk drives or power-off the array during the power-on sequence. If a disk drive is removed or the array is powered off, the array will detect a corrupt format, re-issue the Format command, and restart the formatting process.

Installing CommandView SDM Software

- If you are adding an array to a new system that will require the installation of the CommandView SDM software, continue with "[Install CommandView SDM software](#)"
- If you are adding an array to an existing system that is currently being managed using CommandView SDM, you must add the new array to the management configuration. Perform the following steps to do this.
 - 1 From a CommandView SDM host connected to the array, type the following command:

```
armdiscover
```

Depending on the complexity of the system configuration, the discovery process may take several minutes to complete.
 - 2 Continue with "[Gather Host WWNs](#)".

Step 17. Install CommandView SDM software

Native operating systems

CommandView SDM is supported and can be installed on a host or client running one of the following native operating systems. All array management can be done from a host or client running CommandView SDM.

- HP-UX 11.00/11.11
- Windows 2000/NT 4.0
- Red Hat Linux 7.1

Non-native operating systems

The HP StorageWorks Virtual Array products are supported on the following non-native operating systems. However, CommandView SDM is not supported on these operating systems. CommandView SDM must be installed on a management station running one of the native operating systems, and all array management must be done from there.

- Sun Solaris
- IBM AIX
- NetWare
- MPE/iX
- HP-UX 10.20

Installation Tips

- For the latest updates on CommandView SDM installation procedures, refer to the README file provided on the *HP CommandView SDM* CD-ROM.
- Before installing CommandView SDM, make sure the latest operating system patches and the latest host adapter drivers and patches are installed on the host.
- Have a copy of the *HP StorageWorks CommandView SDM Installation and User Guide* available for reference. It contains more detail on the installation procedures, and additional information on configuring CommandView SDM for client access.
- Make sure you have consulted the *Quick Connect Guide(s)* and *Connectivity Streams Documents* to ensure that all hardware and software components in the host and the FC infrastructure are supported. These guides are available on the following internal HP web site:

<http://hps0.rose.hp.com/spock/#NASL>

Installing Command View SDM on HP-UX

Minimum System Requirements for HP-UX

Host	<ul style="list-style-type: none">■ HP-UX 11.0/11.11 (plus the Support Plus Hardware Enablement Bundle, version September 2001 or later)■ RAM: 256 Mbyte■ Screen Resolution: 800 x 600 (for the GUI) (Recommended 1024 X 768)■ Video Support: 64K colors or better■ Disk Space for Logs: 16 Mbyte per 2 months■ Disk Space: 60 Mbyte in the /var directory
------	---

Locating HP-UX Patches

Support Plus Hardware/Critical Patch Bundle information can be found on the *HP-UX Support Plus* CD-ROM, or on the following web page:

http://www.software.hp.com/SUPPORT_PLUS/hwe.html

The latest Java patches for HP-UX can be downloaded from the following web site:

<http://www.hp.com/products1/unix/java/infolibrary/patches.html>

Installation Tips

- For the latest information on installing and upgrading the software, refer to the README file on the *CommandView SDM* Installation CD. The README is located in the corresponding operating system directory.
- Make sure EMS hardware monitoring is installed and operating on the host **before** installing CommandView SDM. This will ensure that the

array is automatically added to the EMS configuration and array events will be detected and reported.

Installation Steps

- 1 Log onto the system as root or superuser.
 - 2 Insert the CommandView SDM software CD into the CD-ROM drive.
 - 3 Identify the device file for the CD-ROM:

```
ioscan -fnCdisk
```
 - 4 Create a mount point directory. For example:

```
mkdir /cdrom
```

Use a directory that does not exist
 - 5 Mount the CD device file using the device file and directory from the preceding steps. For example:

```
mount -o ro /dev/dsk/c0t0d0 /cdrom
```
 - 6 Run `swinstall` using the appropriate command:
HP-UX 11.00

```
swinstall -s /cdrom/hpux/cvsdm_11_00_v106xx.depot
```

HP-UX 11.11

```
swinstall -s /cdrom/hpux/cvsdm_11_11_v106xx.depot
```

HP-UX 11.20

```
swinstall -s /cdrom/hpux/cvsdm_11_20_v106xx.depot
```

Check the appropriate `/cdrom/hpux` directory for the complete version name of the depot file.
 - 7 Highlight **CMDVIEWSDM** from the list, then **Mark** it for installation from the **Action** menu. All required Command View components will be marked for installation.
 - 8 Start the installation by selecting **Install** from the **Action** menu. Complete the information requested on the `swinstall` screens.
- Note** The installation process may determine that components required by CommandView SDM are already installed. In this case, an error message may be displayed, but it can be ignored.

- 9 Once the software installation is complete, log out, then log back in to reset the path.

This completes the installation of the CommandView SDM software. See the *HP StorageWorks CommandView SDM Installation and User Guide* for information on configuring and using the management software.

Installing Command View SDM on Windows

Minimum System Requirements for Windows

Host	<ul style="list-style-type: none">■ Administrator privileges (Required)■ Windows NT 4.0 with Service Pack 6a or Windows 2000 with Service Pack 1 or 2■ 500 MHz processor speed or better■ 256 Mbyte RAM■ Screen resolution 800 x 600 (for GUI use) (Recommended resolution: 1024 X 768)■ Video support: 64K colors or better■ Disk space for logs: 16 Mbyte per 2 months■ Disk space:<ul style="list-style-type: none">60 Mbytes of permanent space for the application30 Mbytes of temporary space in the Windows Temp directory (typically C:/Temp) used during installation
------	--

Installation Tips

- For the latest software updates, refer to the README file on the *CommandView SDM* CD. The README is located in the corresponding operating system directory.

arrays Installation Steps

- 1 Make sure that SAM is installed and that the SAM Host Agent has been installed on the hosts connected to the array. See "[Installing the SAM HostAgent on OpenView SAM](#)" below.
- 2 Insert the *CommandView SDM* CD into the CD-ROM drive on the host.
- 3 From the **Start** menu, select **Run**.
- 4 Enter the letter of your CD-ROM drive, followed by `win\setup.exe`. For example, if your CD-ROM drive is "E", enter:

```
E:\win\setup.exe
```
- 5 Follow the instructions to complete the installation.



Once the installation is complete, an icon for the CommandView SDM Launcher is placed on the desktop.

Installing the SAM HostAgent on OpenView SAM

When installing the CommandView SDM software in a SAM environment, the SAM Host Agent must be installed on hosts connected to the arrays that will be managed. The SAM Host Agent must be installed and running on a host to allow the SAM management client to detect and manage the array .

- 1 Launch the SAM GUI.
- 2 Select **Tools > Manage Host Agent > Install Host Agent Software**
Refer to the SAM on-line help for more information on installing the host agent.

This completes the installation of the HP CommandView SDM software. See the *HP StorageWorks CommandView SDM Installation and User Guide* for information on configuring and using the management software.

Installing Command View SDM on Linux Red Hat

Minimum System Requirements for Linux Red Hat

Host	<ul style="list-style-type: none">■ Red Hat Linux 7.1 with kernel 2.4.2 (plus patches, see web site mentioned below)■ Intel Pentium III 500 MHz processor■ RAM: 256 Mbyte■ Video Resolution: 800x600 (for GUI) (Recommended 1024 X 768)■ Video Support: 64K colors or better■ Disk Space for Logs: 16 Mbyte per 2 months■ Disk Space: 60 Mbyte
------	--

Where to Get the Latest Linux Information

For the most current supported Linux Kernel version and required patches for CommandView SDM, refer to the web documents, “Kernel Configuration” and “Linux Tips”. These documents and all the latest information can be found in the Using Your Product section of the following HP support web site:

<http://www.hp.com/support/cvsdm>

Installation Tips.

- For the latest software updates, refer to the README file on the *HP StorageWorks CommandView SDM* CD. The README is located in the corresponding operating system directory.
- Before installing CommandView SDM, verify that the timezone system environmental variable, TZ, is properly set. If the TZ variable is not properly set before installation, the system logs may have inconsistent date stamps. If this should occur, set the TZ variable, then stop and restart HostAgent.

Installation Steps

- 1 Log on as root or superuser.
- 2 Create a directory for the software. For example:

```
mkdir /tmp/cmdview
```

- 3 Insert the CommandView SDM software CD into the CD-ROM drive.
- 4 If necessary mount the CD device file. For example:

```
mount /dev/cdrom /mnt/cdrom
```

- 5 Copy the contents of the CD (or download from the web) into the directory created in step 3. For example:

```
cp -pr /mnt/cdrom/linux /tmp/cmdview
```

- 6 Change directories to the /linux install directory by entering:

```
cd /tmp/cmdview/linux
```

- 7 Install the software by entering:

```
install_cmdview -server
```

The installation will take several minutes.

- Note** The Host Agent installer writes a log file to
/tmp/SanMgrInstall.log

The CommandView SDM installer writes a log file to
/tmp/CommandViewInstall.log

- 8 For convenience you may want to add the following line to your path variable:

```
export PATH=$PATH:/opt/sanmgr/commandview/client/sbin
```

Log out, then log back in to reset the path.

This completes the installation of the HP CommandView SDM software. See the *HP StorageWorks CommandView SDM Installation and User Guide* for information on configuring and using the management software.

Final Array Configuration

Step 18. Gather Host WWNs

The host WWN is used for defining the port behavior for a host, and for managing LUN security. Either the node or port WWN can be used. Before building either the host port behavior table or the LUN security table, you must gather the WWNs associated with each host that will be accessing the array.

This step is only required in heterogeneous host environments, or if Secure Manager will be used to implement LUN security.

There are two options for identifying the host WWN.

Using the *armtopology* command

The *armtopology* command available in the CLUI displays information, including the WWN, for any host running CommandView SDM. If CommandView SDM is loaded on all hosts, you can identify all host WWNs using *armtopology*.

The *armtopology* command has the following structure:

```
armtopology <Host_1> <Host_2> <Host_3> ... <Host_n>
```

where *<Host_n>* is the DNS name or the IP address of each host

Example output:

Host	Host Node WWN	Host Port WWN	Product	SerialNumber	C	RG	LUN	Device path
host1	50060b0000017ee0	50060b0000017ee1	A6188A	00USP1001064	1	1	1	\\.\PHYSICALDRIVE1
host2	50060b00000158f8	50060b00000158f9	A6188A	00USP1001064	2	2	0	/dev/rdisk/c0t0d0
host3	50060b000006a964	50060b000006a965	A6189A	00USP1001234	1	1	0	/dev/rdisk/clt0d0

Using Host and Adapter Utilities

For hosts not running CommandView SDM, another method must be used to determine the host WWN. Each host should have specific utilities - operating system or host adapter - which can be used to identify the host WWNs.

- For HP-UX, run the *fcutil* command. For example, for a Fibre Channel array named "fcms1", enter:

```
/opt/fcms/bin/fcmsutil/dev/fcms1
```

- For other supported operating systems use the utilities included with their respective host adapter. The *Quick Connect Guide* downloaded from the internal SPOCK web site should include information on how to locate and use the operating system or host adapter utilities.
- Most FC switches provide a method for displaying the WWN of the device connected to each switch port.

Step 19. Build the Host Port Behavior Table

The host port behavior table is used in heterogeneous environments to identify hosts that do not use the controller default host port behavior. If all hosts use the default behavior, skip this step.

Note On CommandView SDM 1.05 and later, the GUI can also be used to create the host port behavior table. Refer to the *HP StorageWorks CommandView SDM Installation and User Guide* or the on-line help for information on using the GUI.

On the VA 7100 and VA 7400, the maximum number of host port behavior table entries is 32. On the VA 7410, the maximum number of table entries is 113.

The host port behavior table is created using an ASCII text file containing entries identifying a host (by WWN) and its associated behavior. Table entries use the following format:

```
<WWN> <host_port_behavior>
```

<WWN> is the port WWN for the host or the host adapter(s).

<host_port_behavior> is the behavior value for the host. [Table 3](#) lists the valid host port behavior values for each supported operating system.

Table 3 Host Port Behavior Strings

Operating System	VA 7100 (Firmware HP 01 and HP02)	VA 7100 or VA 7400 (Firmware HP11 and greater)	VA 7410 or VA 7110
HP-UX	hpuxfcdriver	Hpux	Hpux
Windows NT	windows/linuxfcdriver	WinNT	WinNT
Windows 2000	windows/linuxfcdriver	Win2000	Win2000
Linux	windows/linuxfcdriver	Linux	Linux
Solaris	Not Supported	Solaris	Solaris
AIX	Not Supported	AIX	AIX
NetWare	Not Supported	NetWare	NetWare
OpenVMS	Not Supported	OpenVMS	OpenVMS
Tru64	Not Supported	Tru64	Tru64
MPE/iX	Not Supported	MPE (VA 7100 only)	Not Supported

To build the host port behavior table:

- 1 Using an ASCII text editor, create a host port behavior table file. In this sample procedure the file is named `behavior.txt`.
- 2 Add an entry to the file for each host or host adapter that will access the array. In this example two entries are made for an NT host, one entry for a Linux host, and one entry for a Solaris host.

```
50060b00000017ee0 winnt
50060c6670019060 winnt
50060b000000158f8 linux
50060b0000006a964 solaris
```

- 3 Save the host port behavior file.
- 4 Write the host port behavior table to the disk array:

```
armhost -w -f behavior.txt <array_id>
```

Step 20. Create LUNs

Creating the desired LUN structure on the array requires close coordination with the customer. Make sure the customer has clearly defined the LUN requirements.

Using the CommandView SDM interface of choice, create the required LUNs. Refer to the on-line help or man pages for more information on creating LUNs.

Valid LUN number ranges are listed in the following table.

Product (Firmware Rev)	LUN Number Range
VA 7100 (HP01 and HP02)	0-63
VA 7100 (HP11 and greater)	0-127
VA 7110/7400/7410	0-1023

A Word About LUN 0

It is recommended that you always create LUN 0. When LUN 0 is created, it is automatically assigned a LUN security permission of configure-write for all hosts. This ensures that regardless of which host you install the CommandView SDM software on, it will be able to manage the array. Because LUN 0 will be accessible to all hosts, you may want to make the size of the LUN small and not use it to store any data.

Step 21. Build the Secure Manager LUN Security Table

LUN security is required in a heterogeneous environment and may also be needed in a homogeneous multi-host environment. For information on managing LUN security, refer to the *HP StorageWorks Secure Manager VA User Guide* included in the Secure Manager Software Media Kit (T1003A).

Step 22. Connect All Hosts to the Array

If you followed the recommendation of not connecting all hosts to the array until the LUN structure and LUN security were in place, this is the time to connect all host to the array.

Installation of the virtual array is now complete!

What's Next?

- For information on operating, troubleshooting, servicing, and upgrading the array, refer to the *HP StorageWorks Virtual Array User & Service Guide* included with your array.
- For information on managing the array, refer to the *HP StorageWorks CommandView SDM Installation and User Guide*.

Solving Installation Problems

The following section identifies common installation problems and solutions. If the problem is not included here, contact support for assistance.

Hardware Problems

PROBLEM

VFP Status Not "Ready"

SOLUTION

If the array status displayed in the VFP is not "Ready", perform the following steps:

- 1 Reset the array:

```
vfpmgr -R full
```

When the reset is complete, check the array status. If it still not Ready, continue with the next step.

- 2 Display array status information:

```
vfpdsp -s
```

Analyze the status information and attempt to identify the problem. If you cannot identify the problem, continue with the next step.

Caution The next step will destroy all data on the array. If this is unacceptable, contact support for assistance. A new array that includes the "Instant Ignition" option contains data that will be lost when formatting the array.

- 3 Format the array:

```
vfpfmt
```

When the format is complete, check the array status. If it still not Ready, continue with the next step.

- 4 Display array status information:

```
vfpdsp -s
```

At the end of the status output is the array status information. Record this information, and contact support for assistance.

PROBLEM

When installing a VA 7400, none of the disk enclosures are visible and one or more of the following errors occur:

Data Unavailable
Hot Spare Unavailable
Capacity Depletion
Catastrophic Redundancy Loss
Missing Drive
No Map Disks

SOLUTION

This is typically caused by failing to set all the FC Loop Speed switches on the DS 2405 LCCs to 1GB/s. Make sure the switch on every LCC is set to 1GB/s. You can quickly identify any LCC that is not set correctly by checking the 2G LED on the back of the disk enclosure. If the LED is on (green), the switch is set to 2GB/s and must be changed.

PROBLEM

When installing a VA 7400, a Phantom Enclosure warning state occurs.

SOLUTION

This is typically caused by installing a DS 2405 Disk System on an array with a controller firmware version earlier than HP14. Make sure the controller firmware is upgraded to the latest version.

Software Problems

PROBLEM

Command View stops working when Secure Manager is enabled.

Command View cannot manage the array.

SOLUTION

If Command View cannot communicate with array, it indicates that the host on which Command View is running does not have "Configure" (C) permissions on any LUN it can access on the array. Typically the LUN 0 entry in the LUN security table is used to grant Configure permission to all hosts. If access to LUN 0 is restricted, the host may no longer be able to use Command View to manage the array.

Correcting this problem requires editing the array LUN security table. If there is another Command View host which can communicate with the array, you can use that host to edit the LUN security table. From the functioning host, perform the steps below.

If there is not another Command View host, you will have to disable LUN security using the virtual front panel. For more information on using the virtual

front panel, see the *hp surestore virtual arrays installation guide*. When security has been disabled, continue with the steps below.

- 1 Read the LUN security table from the array into a file:

```
armsecure -r -f <filename> -p <password> <array-id>
```

- 2 Identify which LUNs the non-functioning host can access. You will need to know the World Wide Node name of the host to identify its entries in the table.

- 3 On one of the entries which grants the host access to a LUN, modify the permissions to include configure (C). The entry will look like this, which grants access to LUN 1:

```
NODEWWN 4001a5500b060012 1 WC ← Add "C" to permission
```

- 4 Write the updated LUN security table back to the array:

```
armsecure -w -c -f <filename> -p <password> <array-id>
```

- 5 Enable Secure Manager:

```
armsecure -e -p <password> <array-id>
```

- 6 Rescan for arrays from the host.

- 7 Discover the management path to the array:

```
armdiscover
```

PROBLEM

I get a 401 error when trying to manage the array from a browser.

SOLUTION

This indicates that the correct access permissions have not been set on the Command View host. Access permissions are managed using a configuration file on the Command View host. To allow a remote client to manage the array, the IP address of the remote client must be added to the file.

The following files are used to control client access:

- `access.dat` - HP-UX, Linux, and Windows (standard installation)
- `authorizedClients.dat` - HP OpenView Storage Area Manager (SAM) installation

To set up remote client access:

- 1 On the CommandView SDM host, open the configuration file in an ASCII text editor. The file is located in the following directory:

```
/opt/sanmgr/hostagent/config/ << HP-UX and Linux  
  \sanmgr\hostagent\config\   << Windows  
  \sanmgr\managementserver\config\ << Windows - HP OpenView SAM
```

- 2 Add the IP address for each client requiring access to the arrays connected to the host. Or remove the IP address for any clients you no longer want to have access.

Single client IP addresses can be added, or a range of IP addresses can be added using the wild card *"*"*. For example; 10.62.128.* grants access to any client on subnet 128. The use of wildcards is recommended when connecting from clients configured for dynamic host configuration protocol (DHCP).

- 3 Save the configuration file.
- 4 Verify that the client browser now has access by entering the following URL:

```
http://<hostname-or-ipaddress>:4096
```

The following message should be returned by the host:

```
(c) Copyright 2000 - Hewlett-Packard Company  
commandview sdm web server
```

PROBLEM

After installing Command View, the arrays I expected to see in the Launcher do not appear.

When I run the `armdsp -i` command, the arrays I expected to see in the output do not appear.

SOLUTION

During the software installation process, the `armdiscover` command is launched to locate all arrays connected to the host. This information is then used to populate the Launcher screen. If there is a functional array connected to the host that does not appear in the Launcher screen, it may be necessary to repeat the discovery process.

To rediscover the arrays:

- 1 Check the disk array hardware and make sure it is operating properly, and that the array is connected to the host, switch, or hub.
- 2 Manually stop the HostAgent and OpenDIAL services. Refer to the *hp command view sdm installation and user guide* for more information on this procedure.
- 3 Delete all files in the `../sanmgr/hostagent/pdb` folder. This causes OpenDIAL to rebuild the database files with the array devices that are discovered.
- 4 Manually restart the HostAgent and OpenDIAL services.
- 5 Execute the `armdiscover` command to initiate the discovery process.

- 6 Check the Launcher to ensure the array is now displayed. You can also execute the `armdsp -i` command to display the arrays that were discovered.

If this does not solve the problem, contact support for assistance.