

# SONY®

3-082-146-11(1)

## Digital Still Camera

### Operating Instructions

Before operating the unit, please read this manual thoroughly, and retain it for future reference.

### Owner's Record

The model and serial numbers are located on the bottom. Record the serial number in the space provided below. Refer to these numbers whenever you call upon your Sony dealer regarding this product.

Model No. DSC-P32/P52/P72

Serial No. \_\_\_\_\_

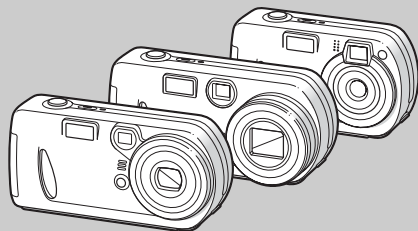

**Cyber-shot**  
Digital Still Camera



MEMORY STICK™

## DSC-P32/P52/P72

© 2003 Sony Corporation

Getting started \_\_\_\_\_

Shooting still images \_\_\_\_\_

Viewing still images \_\_\_\_\_

Deleting still images \_\_\_\_\_

Before advanced operations \_\_\_\_\_

Advanced still image shooting \_\_\_\_\_

Advanced still image viewing \_\_\_\_\_

Still image editing \_\_\_\_\_

Enjoying movies \_\_\_\_\_

Enjoying images on your computer \_\_\_\_\_

Troubleshooting \_\_\_\_\_

Additional information \_\_\_\_\_

Index \_\_\_\_\_

## WARNING

To prevent fire or shock hazard, do not expose the unit to rain or moisture.

## For the Customers in the U.S.A.

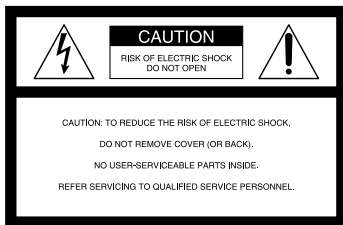

This symbol is intended to alert the user to the presence of uninsulated “dangerous voltage” within the product’s enclosure that may be of sufficient magnitude to constitute a risk of electric shock to persons.



This symbol is intended to alert the user to the presence of important operating and maintenance (servicing) instructions in the literature accompanying the appliance.

If you have any questions about this product, you may call:

Sony Customer Information Services Center  
1-800-222-SONY (7669)

The number below is for the FCC related matters only.

### Regulatory Information

#### Declaration of Conformity

Trade Name: SONY  
Model No.: DSC-P32  
Responsible Party: Sony Electronics Inc.  
Address: 680 Kinderkamack  
Road, Oradell, NJ  
07649 USA  
Telephone No.: 201-930-6972

This device complies with Part 15 of the FCC Rules. Operation is subject to the following two conditions: (1) This device may not cause harmful interference, and (2) this device must accept any interference received, including interference that may cause undesired operation.

#### Declaration of Conformity

Trade Name: SONY  
Model No.: DSC-P52  
Responsible Party: Sony Electronics Inc.  
Address: 680 Kinderkamack  
Road, Oradell, NJ  
07649 USA  
Telephone No.: 201-930-6972

This device complies with Part 15 of the FCC Rules. Operation is subject to the following two conditions: (1) This device may not cause harmful interference, and (2) this device must accept any interference received, including interference that may cause undesired operation.

#### Declaration of Conformity

Trade Name: SONY  
Model No.: DSC-P72  
Responsible Party: Sony Electronics Inc.  
Address: 680 Kinderkamack  
Road, Oradell, NJ  
07649 USA  
Telephone No.: 201-930-6972

This device complies with Part 15 of the FCC Rules. Operation is subject to the following two conditions: (1) This device may not cause harmful interference, and (2) this device must accept any interference received, including interference that may cause undesired operation.

## CAUTION

You are cautioned that any changes or modifications not expressly approved in this manual could void your authority to operate this equipment.

### Note:

This equipment has been tested and found to comply with the limits for a Class B digital device, pursuant to Part 15 of the FCC Rules. These limits are designed to provide reasonable protection against harmful interference in a residential installation. This equipment generates, uses, and can radiate radio frequency energy and, if not installed and used in accordance with the instructions, may cause harmful interference to radio communications. However, there is no guarantee that interference will not occur in a particular installation. If this equipment does cause harmful interference to radio or television reception, which can be determined by turning the equipment off and on, the user is encouraged to try to correct the interference by one or more of the following measures:

- Reorient or relocate the receiving antenna.
- Increase the separation between the equipment and receiver.
- Connect the equipment into an outlet on a circuit different from that to which the receiver is connected.
- Consult the dealer or an experienced radio/TV technician for help.

The supplied interface cable must be used with the equipment in order to comply with the limits for a digital device pursuant to Subpart B of Part 15 of FCC Rules.

## For the Customers in the U.S.A. and Canada

### RECYCLING NICKEL METAL HYDRIDE BATTERIES

Nickel Metal Hydride batteries are recyclable.

You can help preserve our environment by returning your used rechargeable batteries to the collection and recycling location nearest you.



For more information regarding recycling of rechargeable batteries, call toll free 1-800-822-8837, or visit <http://www.rbc.org/>

**Caution:** Do not handle damaged or leaking Nickel Metal Hydride batteries.

### CAUTION

TO PREVENT ELECTRIC SHOCK, DO NOT USE THIS POLARIZED AC PLUG WITH AN EXTENSION CORD, RECEPTACLE OR OTHER OUTLET UNLESS THE BLADES CAN BE FULLY INSERTED TO PREVENT BLADE EXPOSURE.

## Notice on the supplied battery charger for the customers in the United Kingdom

A moulded plug complying with BS 1363 is fitted to this equipment for your safety and convenience.

Should the fuse in the plug supplied need to be replaced, a 5 AMP fuse approved by ASTA or BSI to BS 1362, (i.e., marked with ⚡ or ⚡ mark) must be used.

If the plug supplied with this equipment has a detachable fuse cover, be sure to attach the fuse cover after you change the fuse. Never use the plug without the fuse cover. If you should lose the fuse cover, please contact your nearest Sony service station.

## For the Customers in Europe

This product has been tested and found compliant with the limits sets out in the EMC Directive for using connection cables shorter than 3 meters (9.8 feet).

### Attention

The electromagnetic fields at the specific frequencies may influence the picture and sound of this digital camera.

### Notice

If static electricity or electromagnetism causes data transfer to discontinue midway (fail), restart the application or disconnect and connect the USB cable again.

Certain countries may regulate disposal of the battery used to power this product. Please consult with your local authority.

## “Memory Stick”



### For the Customers in the U.S.A. and Canada

THIS CLASS B DIGITAL DEVICE COMPLIES WITH PART 15 OF THE FCC RULES AND THE CANADIAN ICES-003 OPERATION IS SUBJECT TO THE FOLLOWING TWO CONDITIONS: (1) THIS DEVICE MAY NOT CAUSE HARMFUL INTERFERENCE, AND (2) THIS DEVICE MUST ACCEPT ANY INTERFERENCE RECEIVED, INCLUDING INTERFERENCE THAT MAY CAUSE UNDESIRE OPERATION.

## Before using your camera

### Trial recording

Before you record one-time events, you may want to make a trial recording to make sure that the camera is working correctly.

### No compensation for contents of the recording

Contents of the recording cannot be compensated for if recording or playback is not possible due to a malfunction of your camera or recording medium, etc.

### Back up recommendation

To avoid the potential risk of data loss, always copy (back up) data to a disk.

### Notes on image data compatibility

- This camera conforms with the Design rule for Camera File system universal standard established by the JEITA (Japan Electronics and Information Technology Industries Association).
- Playback of images recorded with your camera on other equipment and playback of images recorded or edited with other equipment on your camera are not guaranteed.

### Precaution on copyright

Television programs, films, video tapes, and other materials may be copyrighted. Unauthorized recording of such materials may be contrary to the provision of the copyright laws.

### Do not shake or strike the camera

In addition to malfunctions and inability to record images, this may render the “Memory Stick” unusable or image data breakdown, damage or loss may occur.

### LCD screen, LCD finder (only models with a LCD finder) and lens

- The LCD screen and the LCD finder are manufactured using extremely high-precision technology so over 99.99% of the pixels are operational for effective use. However, there may be some tiny black points and/or bright points (white, red, blue or green in color) that constantly appear on the LCD screen and the LCD finder. These points are normal in the manufacturing process and do not affect the recording in any way.
- Be careful when placing the camera near a window or outdoors. Exposing the LCD screen, the finder or the lens to direct sunlight for long periods may cause malfunctions.
- Do not press the LCD screen hardly. The screen may be uneven and that may cause a malfunction.
- Images may be trailed on the LCD screen in a cold location. This is not a malfunction.

### The power zoom lens (for the DSC-P72 only)

This camera is equipped with power zoom lens. Be careful not to bump the lens, and be careful not to apply force to it.

### **Remove dirt from the surface of the flash**

If the dirt changes color or sticks to the surface of the flash due to the heat of the flash, sufficient light may not be emitted.

### **Do not get the camera wet**

When taking pictures outdoors in the rain or under similar conditions, be careful not to get the camera wet. If moisture condensation occurs, see page 108 and follow the instructions on how to remove it before using the camera.

### **Do not expose the camera to sand or dust**

Using the camera in sandy or dusty locations may cause a malfunction.

### **Do not aim the camera at the sun or other bright light**

This may cause irrecoverable damage to your eyes or the malfunction of your camera.

### **Notes on locations where you can use the camera**

- Do not use the camera near a location that generates strong radio waves or emits radiation. The camera may not be able to record or play back properly.
- Do not use the camera near a TV, radio, or tuner. This may cause noise to interfere the camera.

### **The pictures used in this manual**

The photographs used as examples of pictures in this manual are reproduced images, and are not actual images shot using this camera.

### **The illustrations and screen status used in this manual**

The illustrations and screen status used in this manual are of the DSC-P72 unless noted otherwise.

### **Trademarks**

- “Memory Stick,” , and “MagicGate Memory Stick” are trademarks of Sony Corporation.
- “Memory Stick Duo” and **MEMORY STICK DUO** are trademarks of Sony Corporation.
- “Memory Stick PRO” and **MEMORY STICK PRO** are trademarks of Sony Corporation.
- “MagicGate” and **MAGICGATE** are trademarks of Sony Corporation.
- Microsoft and Windows are registered trademarks of the U.S. Microsoft Corporation in the United States and other countries.
- Macintosh, Mac OS, QuickTime, iBook, and Power Mac are trademarks or registered trademarks of Apple Computer, Inc.
- “Pentium” is a trademark or a registered trademark of Intel Corporation.
- In addition, system and product names used in this manual are, in general, trademarks or registered trademarks of their respective developers or manufacturers. However, the <sup>TM</sup> or ® marks are not used in all cases in this manual.

# Table of contents

Before using your camera .....	4
Identifying the parts .....	8

## Getting started

Preparing batteries .....	14
Charging the batteries .....	14
Inserting the batteries .....	16
Using an external power source .....	19
Using your camera abroad .....	19
Turning your camera on/off .....	20
How to use the control button .....	20
Setting the date and time .....	21

## Shooting still images

Inserting and removing a “Memory Stick” .....	23
Setting the still image size .....	24
Image size and quality .....	25
Basic still image shooting	
– using auto mode .....	26
Checking the last image shot	
– Quick Review .....	28
Using the zoom feature .....	29
Shooting close-ups – Macro (DSC-P72 only) .....	30
Using the self-timer .....	31
Selecting a flash mode .....	32
Shooting with the finder .....	34

Inserting the date and time on a still image .....	35
--	----

## Viewing still images

Viewing images on the LCD screen of your camera .....	36
Viewing images on a TV screen .....	38

## Deleting still images

Deleting images .....	40
Formatting a “Memory Stick” .....	44

## Before advanced operations

How to setup and operate your camera .....	45
Changing menu settings .....	45
Changing items in the SET UP screen .....	45
Deciding the still image quality .....	46
Creating or selecting a folder .....	46
Creating a new folder .....	47
Selecting the recording folder .....	47

## Advanced still image shooting

Choosing a focus method .....	48
Setting the distance to the subject	
– Focus preset .....	49
Adjusting the exposure	
– EV adjustment .....	50
Selecting a metering mode .....	51
Adjusting color tones – White Balance .....	52
Adjusting the flash level – Flash level .....	53
Shooting multiple frames	
– Clip Motion .....	54
Shooting in Multi Burst mode	
– Multi Burst .....	55
Shooting two images in succession	
– Burst 2 .....	56
Shooting still images for e-mail	
– E-Mail .....	56
Shooting still images with audio files	
– Voice .....	57
Shooting according to scene conditions .....	58
Adding special effects	
– Picture Effect .....	60

## Advanced still image viewing

Selecting the folder and playing back images – Folder .....	61
Enlarging a portion of a still image.....	62
Enlarging an image	
– Playback zoom.....	62
Recording an enlarged image	
– Trimming .....	63
Playing back successive images	
– Slide show.....	63
Rotating still images – Rotate .....	64
Playing back images shot in Multi Burst mode .....	65
Playing back continuously .....	65
Playing back frame by frame	
– Jog playback .....	65

## Still image editing

Protecting images – Protect.....	67
On the single screen.....	67
On the Index (nine-image) screen.....	67
On the Index (triple-image) screen .....	68
Changing image size – Resize.....	69
Choosing images to print	
– Print (DPOF) mark .....	70
On the single screen.....	70
On the Index (nine-image) screen.....	70
On the Index (triple-image) screen .....	71

## Enjoying movies

Shooting movies .....	72
Viewing movies on the LCD screen.....	73
Deleting movies .....	74
On the single screen.....	74
On the Index (nine-image) screen .....	74
On the Index (triple-image) screen.....	75
Editing movies.....	76
Cutting movies.....	76
Deleting unnecessary portions of movies .....	77

## Enjoying images on your computer

Copying images to your computer	
– For Windows users.....	78
Installing the USB driver.....	79
Installing “Image Transfer” .....	80
Installing “ImageMixer”.....	81
Connecting the camera to your computer .....	82
Copying images using “Image Transfer” .....	83
Changing “Image Transfer” settings ..	84
Copying images without using “Image Transfer” .....	84
Viewing the images on your computer .....	85

Image file storage destinations and file names .....	86
Copying images to your computer	
– For Macintosh users.....	88
Creating a Video CD .....	90

## Troubleshooting

Troubleshooting .....	91
Warnings and messages .....	98
Self-diagnosis display – If a code starting with an alphabet letter appears.....	100

## Additional information

The number of images that can be saved/shooting time.....	101
Menu items .....	102
SET UP items .....	106
Precautions .....	108
The “Memory Stick” .....	109
The nickel-metal hydride batteries .....	110
The battery charger.....	111
Specifications .....	111
The LCD screen .....	113

## Index

Index.....	116
------------	-----

## Identifying the parts

(DSC-P72)

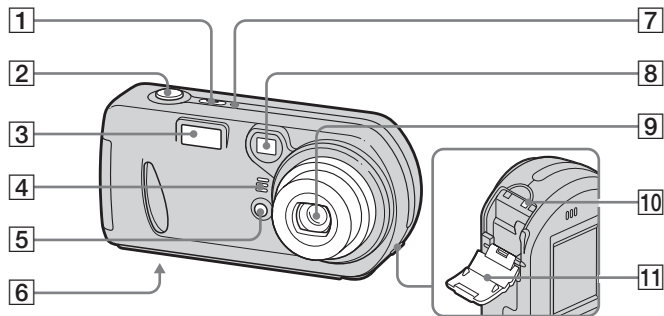

- 1 POWER button** (20)
- 2 Shutter button** (26)
- 3 Flash** (32)
- 4 Microphone**
- 5 Self-timer lamp** (31)/  
**AF illuminator** (33)
- 6 Tripod receptacle (bottom surface)**
- 7 POWER lamp** (20)
- 8 Finder window**
- 9 Lens**

- 10 Access lamp** (23)
- 11 "Memory Stick" cover** (23)

- "3.2MEGA PIXELS" shown on the surface of the camera is the number of effective pixels of the CCD. However, the maximum number of pixels recorded is 3.1 mega pixels. The indication of the number of effective pixels of the CCD is a recommendation of the JCIA (Japan Camera Industry Association).

- Use a tripod with a screw length of less than 5.5 mm (7/32 inch). You will be unable to firmly secure the camera to tripods having longer screws, and may damage the camera.



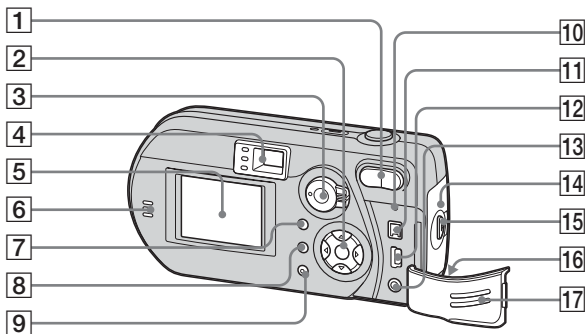

- 10 **RESET button** (91)
- 11 **DC IN jack** (19)
- 12 **USB jack** (82)
- 13 **A/V OUT (MONO) jack** (38)
- 14 **Battery cover**
- 15 **OPEN button** (16)
- 16 **Wrist strap hook**

**Attaching the wrist strap**

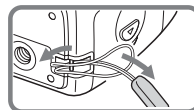

- 1 **Zoom buttons (during shooting)** (29)/**Index buttons (during playback)** (37)
- 2 **Control button** (Menu on) (▲/▼/◀/▶/●) (20)/ (Menu off) (⚡/🔊/📷/📹) (32/31/28/30)
- 3 **Mode selector** (21)
  - ▶: To view or edit images
  - 📷: To shoot still images
  - 📹: To shoot movies/Clip Motion images/Multi Burst mode images
  - SET UP: To set the SET UP items

- 4 **Finder** (34)
  - Self-timer/recording lamp (red) (31/27)
  - AE/AF lock lamp (green) (26)
  - ⚡ (Flash charge) lamp (orange) (32)

- 5 **LCD screen**
- 6 **Speaker**
- 7 **MENU button** (102)
- 8 **□ (LCD status/LCD on/off) button** (34)
- 9 **📷 / 🗑️ (Image Size/Delete) button** (24/40)

- 17 **Jack cover**

(DSC-P52)

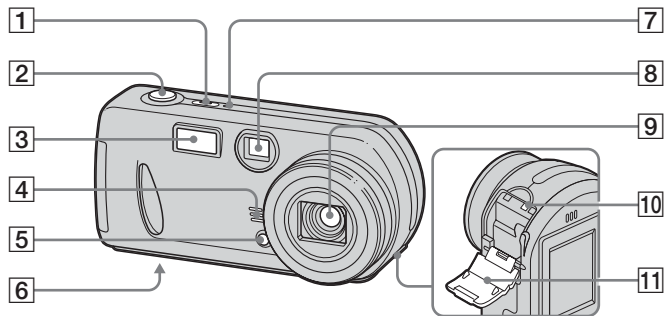

- 1 POWER button** (20)
- 2 Shutter button** (26)
- 3 Flash** (32)
- 4 Microphone**
- 5 Self-timer lamp** (31)/  
**AF illuminator** (33)
- 6 Tripod receptacle (bottom surface)**
- 7 POWER lamp** (20)
- 8 Finder window**
- 9 Lens**

- 10 Access lamp** (23)
- 11 "Memory Stick" cover** (23)

- "3.2MEGA PIXELS" shown on the surface of the camera is the number of effective pixels of the CCD. However, the maximum number of pixels recorded is 3.1 mega pixels. The indication of the number of effective pixels of the CCD is a recommendation of the JCIA (Japan Camera Industry Association).

- Use a tripod with a screw length of less than 5.5 mm (7/32 inch). You will be unable to firmly secure the camera to tripods having longer screws, and may damage the camera.

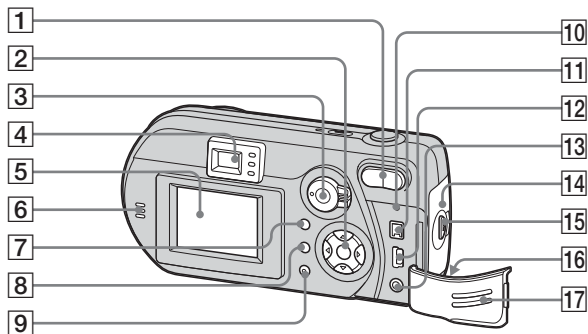

- 10 RESET button (91)
- 11 DC IN jack (19)
- 12 USB jack (82)
- 13 A/V OUT (MONO) jack (38)
- 14 Battery cover
- 15 OPEN button (16)
- 16 Wrist strap hook

**Attaching the wrist strap**

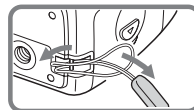

- 1 Zoom buttons (during shooting) (29)/Index buttons (during playback) (37)
- 2 Control button (Menu on) (▲/▼/◀/▶/●) (20)/ (Menu off) (⚡/🔊/📷/🗑️) (32/31/28/51)
- 3 Mode selector (21)
  - ▶: To view or edit images
  - 📷: To shoot still images
  - 🎥: To shoot movies/Clip Motion images/Multi Burst mode images
  - SET UP: To set the SET UP items

4 Finder (34)

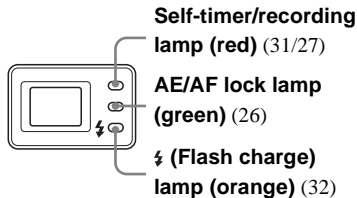

- 5 LCD screen
- 6 Speaker
- 7 MENU button (102)
- 8 [ ] (LCD status/LCD on/off) button (34)
- 9 📷 / 🗑️ (Image Size/Delete) button (24/40)

17 Jack cover

(DSC-P32)

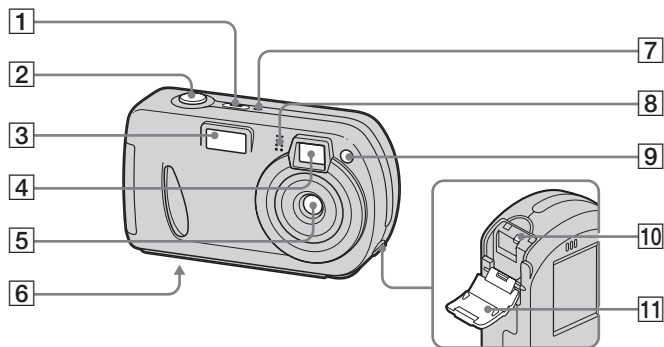

- 1 POWER button** (20)
- 2 Shutter button** (26)
- 3 Flash** (32)
- 4 Finder window**
- 5 Lens**
- 6 Tripod receptacle (bottom surface)**
- 7 POWER lamp** (20)
- 8 Microphone**
- 9 Self-timer lamp** (31)/  
**AF illuminator** (33)

- 10 Access lamp** (23)
- 11 "Memory Stick" cover** (23)

- "3.2MEGA PIXELS" shown on the surface of the camera is the number of effective pixels of the CCD. However, the maximum number of pixels recorded is 3.1 mega pixels. The indication of the number of effective pixels of the CCD is a recommendation of the JCIA (Japan Camera Industry Association).

- Use a tripod with a screw length of less than 5.5 mm (7/32 inch). You will be unable to firmly secure the camera to tripods having longer screws, and may damage the camera.

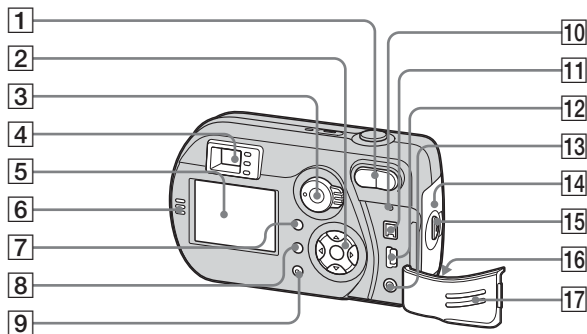

- 10 RESET button (91)
- 11 DC IN jack (19)
- 12 USB (USB) jack (82)
- 13 A/V OUT (MONO) jack (38)
- 14 Battery cover
- 15 OPEN button (16)
- 16 Wrist strap hook

**Attaching the wrist strap**

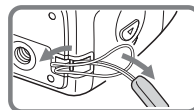

- 1 Zoom buttons (during shooting) (29)/Index buttons (during playback) (37)
- 2 Control button (Menu on) (▲/▼/◀/▶/●) (20)/ (Menu off) (⚡/🔊/📷/📺) (32/31/28/51)
- 3 Mode selector (21)
  - ▶: To view or edit images
  - 📷: To shoot still images
  - 📺: To shoot movies/Clip Motion images/Multi Burst mode images
  - SET UP: To set the SET UP items

- 4 Finder (34)

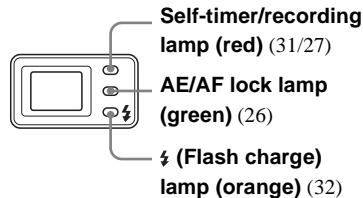

- 5 LCD screen
- 6 Speaker
- 7 MENU button (102)
- 8 [ ] (LCD status/LCD on/off) button (34)
- 9 [ ] / [ ] (Image Size/Delete) button (24/40)

- 17 Jack cover

## Preparing batteries

Use the following batteries in this camera.

### Acceptable batteries

HR 15/51:HR6 (size AA) Nickel-Metal Hydride batteries (2)

- NH-AA-DA (2) (supplied)
- NH-AA-2DA twin-pack (not supplied)

R6 (size AA) alkaline batteries (2)

### Batteries that cannot be used

Manganese batteries, lithium batteries, nickel-cadmium batteries

If you use the batteries described above, we cannot guarantee full performance of the camera by property of the batteries, such as brownout of the batteries.

The battery remaining indicator does not display the correct information.

- When alkaline batteries are used, take note of the following information.
  - There is a big difference in the performance of batteries of different types and of batteries made by different manufacturers. This is especially true in low temperatures, where some batteries are noticeably weaker. You may not be able to shoot in temperatures below 5°C (41°F).
  - The battery remaining indicator may not display the correct information.

## Charging the batteries

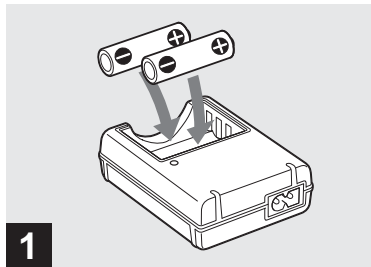

➔ **Insert Nickel-Metal Hydride batteries into the battery charger (supplied) with the correct polarity +/-.**

- You cannot charge alkaline batteries using the battery charger.
- Be sure to charge the Nickel-Metal Hydride batteries supplied with your camera before using them.
- Connect the battery charger to an easily accessible wall outlet (wall socket) close by.
- Even if the CHARGE lamp is not lit, the set is not disconnected from the AC power source (mains) as long as it is connected to the wall outlet (wall socket). If some trouble occurs while using the battery charger, immediately shut off the power by disconnecting the plug from the wall outlet (wall socket).

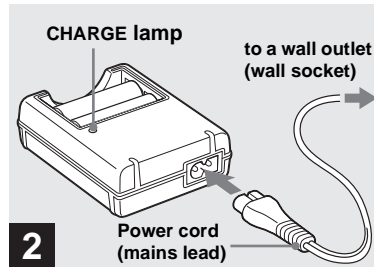

➔ **Connect the battery charger to a wall outlet (wall socket) using the power cord (mains lead).**

Charging starts, and the CHARGE lamp lights. When the CHARGE lamp goes out, charging is finished. For details on the battery charger, see page 111.

### To remove the batteries

Press the - end of the battery down in order to raise the + end, then remove the battery.

- When charging is finished, disconnect the power cord (mains lead) from the wall outlet (wall socket), and remove the Nickel-Metal Hydride batteries from the battery charger.

## Charging time

Nickel-Metal Hydride battery	Charging time
NH-AA-DA × 2 (supplied)	Approx. 6 hours

This represents the time required to charge fully depleted Nickel-Metal Hydride batteries using the supplied battery charger in an environment where the ambient temperature is 25°C (77°F).

- Charging is complete in approximately six hours. The CHARGE lamp may remain lit longer than six hours, but this is not a malfunction.
- If you use the BC-CSQ2 battery charger supplied with the STAMINA “Super Quick charge” kit (not supplied), the batteries will charge faster.

### Charging time

When charging two Nickel-Metal Hydride batteries: Approximately 2 hours 30 minutes

When charging four Nickel-Metal Hydride batteries: Approximately 5 hours

## Notes on the Nickel-Metal Hydride batteries

- If the poles of the Nickel-Metal Hydride batteries are dirty, the batteries may not charge properly. Occasionally clean the poles of the batteries and the terminals of the charger by wiping them with a dry cloth.
- When transporting the Nickel-Metal Hydride batteries, be sure to use the battery case (supplied). If the +/- metal terminals are shorted, there is a possibility of danger from excessive heat or fire.
- At the time of purchase, or when the Nickel-Metal Hydride batteries have not been used for a long time, they may not fully charge. This is typical of this type of battery, and is not a malfunction. If this happens, repeatedly using up the battery fully, and then recharging it, should correct the problem.
- Even when Nickel-Metal Hydride batteries are not being used they lose their charge naturally over time. It is recommended that you recharge the batteries just before using them.
- If you recharge Nickel-Metal Hydride batteries before fully using up the existing charge, the so-called memory effect\* can occur, and the low battery warning will be triggered sooner than expected. Charging the battery after fully depleting the existing charge should correct the problem.

\* The “memory effect” – the situation in which a battery temporarily accepts a less than full charge.

- To use up the batteries completely, put the camera in the slide show mode (page 63) and leave it that way until the batteries are used up.
- Do not peel off the external seals or damage the batteries. Never use batteries from which the seals have been partially or completely removed, or batteries that have been split in any way. These may cause leakage, explosion, or heat-up of the battery, and personal scald or injury may be caused. These may cause a malfunction of the battery charger.

## Inserting the batteries

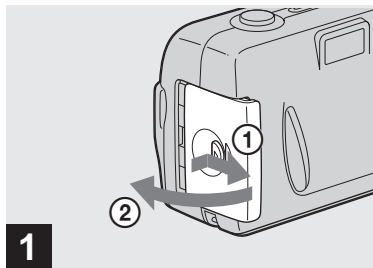

### → Open the battery cover.

Slide it in the direction of the arrow with the OPEN button pressed, and it opens out.

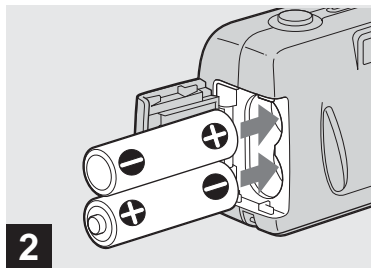

### → Insert the batteries.

Match the +/- poles of the batteries to the +/- marks inside the battery case.

- Occasionally clean the poles of the batteries and the terminals of the battery cover by wiping them with a dry cloth. If the poles of the batteries or the terminals become covered with a film of dirt or oil from the skin, the operating time of the camera can be greatly reduced.

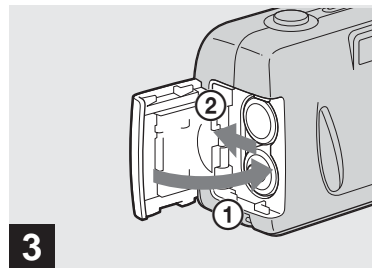

### → Close the battery cover.

Close the battery cover while holding the batteries in. The cover is closed when it clicks.

### To remove the batteries





Stand the camera on end, open the battery cover upward, then remove the batteries.

- Make sure you do not drop the batteries when opening or closing the battery cover.



## Battery remaining indicator (When using the Nickel-Metal Hydride batteries)

As the battery power decreases with use, the battery remaining indicator displays the amount of power remaining using the following symbols.

Battery remaining indicator	Battery remaining guidelines (A full charge is 100%)
	Sufficient power remaining
	Battery half full
	Battery low, recording/ playback will stop soon.
	Change the batteries for fully charged ones, or charge these batteries. (The warning indicator flashes.)

- If the LCD screen is off, press  to turn it on.
- Based on the conditions under which the camera is being used and the state of the charge, or on the environment, this information may not be correctly indicated.
- When the AC Adaptor (not supplied) is being used, the remaining battery information is not displayed.

## The Power Save function

When the Power Save function is set to On, you can shoot for a longer period of time. Turn the mode selector to SET UP, and set [Power Save] in Setup 1 to [On]. The factory setting of the camera is set to [On] (page 107).

We recommend that you set [Power Save] to [On] when using alkaline batteries.

### When the Power Save function is On

- In shooting still images, the focus only focuses when the shutter is pushed down halfway.
- While charging the flash, the  lamp flashes and the LCD screen is turned off. After the flash is completely charged, the LCD screen turns on.

## Battery life and the number of images that can be recorded/ played back

The tables show approximate guidelines for the length of time the camera can be used when you shoot in Normal mode in an environment where the ambient temperature is 25°C (77°F), and the batteries are fully charged. The guidelines for the number of images that can be recorded or played back allow for changing the supplied “Memory Stick” as necessary. Actual results may differ slightly from these, depending on the conditions of use.

### Shooting still images Under the average conditions<sup>1)</sup>

Image size	NH-AA-DA (2) (supplied)		
	LCD screen	No. of images	Battery life (min.)
DSC-P72			
3.1M	On	Approx. 300	Approx. 150
	Off	Approx. 500	Approx. 250
VGA	On	Approx. 300	Approx. 150
	Off	Approx. 500	Approx. 250
DSC-P52			
3.1M	On	Approx. 320	Approx. 160
	Off	Approx. 540	Approx. 270
VGA	On	Approx. 320	Approx. 160
	Off	Approx. 540	Approx. 270
DSC-P32			
3.1M	On	Approx. 320	Approx. 160
	Off	Approx. 540	Approx. 270
VGA	On	Approx. 320	Approx. 160
	Off	Approx. 540	Approx. 270

## Inserting the batteries (continued)

Image size	R6 (Size AA) alkaline battery (2) (not supplied)		
	LCD screen	No. of images	Battery life (min.)
DSC-P72			
3.1M	On	Approx. 70	Approx. 35
	Off	Approx. 130	Approx. 65
VGA	On	Approx. 70	Approx. 35
	Off	Approx. 130	Approx. 65
DSC-P52			
3.1M	On	Approx. 80	Approx. 40
	Off	Approx. 140	Approx. 70
VGA	On	Approx. 80	Approx. 40
	Off	Approx. 140	Approx. 70
DSC-P32			
3.1M	On	Approx. 80	Approx. 40
	Off	Approx. 140	Approx. 70
VGA	On	Approx. 80	Approx. 40
	Off	Approx. 140	Approx. 70

When using Sony alkaline batteries

<sup>1)</sup> Shooting under the following conditions:

- The image quality is set to [Fine].
- Shooting one image every 30 seconds.
- Alternatively pressing the zoom W and T buttons fully for each shot (DSC-P72/P52 only).
- Using the flash once in every two shots.
- Turning on and off once in every ten shots.

### Playing back<sup>2)</sup> still images

Image size	NH-AA-DA (2) (supplied)	
	No. of images	Battery life (min.)
DSC-P72		
3.1M	Approx. 5400	Approx. 270
VGA	Approx. 5400	Approx. 270
DSC-P52		
3.1M	Approx. 6000	Approx. 300
VGA	Approx. 6000	Approx. 300
DSC-P32		
3.1M	Approx. 6000	Approx. 300
VGA	Approx. 6000	Approx. 300

<sup>2)</sup> Showing single images in order, one approximately every three seconds

### Shooting<sup>3)</sup> movies

	NH-AA-DA (2) (supplied)	
	LCD screen On	LCD screen Off
DSC-P72	Approx. 160	Approx. 210
DSC-P52	Approx. 160	Approx. 210
DSC-P32	Approx. 160	Approx. 210

<sup>3)</sup> Continuous shooting with a picture size of 160 (Mail)

- The battery life and the number of images recordable decrease under the following conditions:
  - At low temperatures.
  - Using the flash.
  - Turning the camera on and off frequently.
  - Using the zoom heavily (DSC-P72/P52 only)
  - When [LCD Backlight] is set to [Bright].
  - When [Power Save] is set to [Off].
  - After using the batteries repeatedly over a long period of time or after often allowing it to self-discharge after charging (page 110).

## Using an external power source

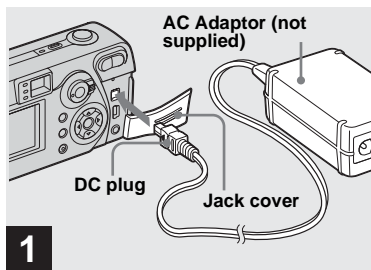

- ➔ **Open the jack cover, then connect the AC-LS5 AC Adaptor (not supplied) to the DC IN jack of the camera.**

Connect the plug with the ▲ mark facing toward the LCD screen.

- **Be sure to use the AC-LS5 AC Adaptor. Other AC adaptors cannot be used with this camera.**
- Connect the AC Adaptor to an easily accessible wall outlet (wall socket) close by. If some trouble occurs while using the adaptor, immediately shut off the power by disconnecting the plug from the wall outlet (wall socket).

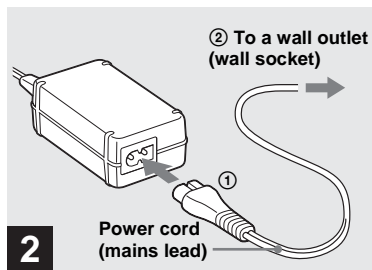

- ➔ **Connect the power cord (mains lead) to the AC Adaptor and to a wall outlet (wall socket).**

- When you have finished using the AC Adaptor, disconnect it from the DC IN jack of the camera.
- The set is not disconnected from the AC power source (mains) as long as it is connected to the wall outlet (wall socket), even if the unit itself has been turned off.

## Using your camera abroad

### Power sources

You can use your camera in any country or area with the supplied battery charger or AC Adaptor (not supplied) within 100 V to 240 V AC, 50/60 Hz. Use a commercially available AC plug adaptor [a], if necessary, depending on the design of the wall outlet (wall socket) [b].

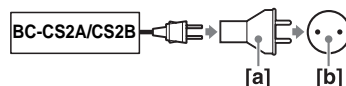

- Do not use an electrical transformer (travel converter), as this may cause a malfunction.

## Turning your camera on/off

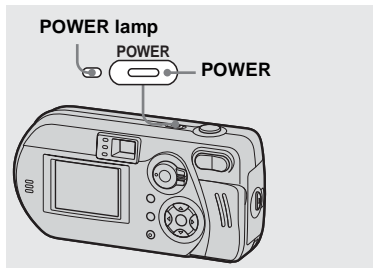

➔ **Press POWER to turn on the camera.**

The POWER lamp lights in green and the power is on. When you turn on the camera for the first time, the Clock Set screen appears (page 21).

### To turn off the power

Press POWER again, the POWER lamp goes out, and the camera turns off.

- **Do not remove the batteries or AC Adaptor with the lens portion pulled out. This may cause a malfunction (DSC-P72 only).**
- When you turn the power on with the mode selector set to or , the lens begins to move (DSC-P72 only). Please be careful not to touch the lens.

## The Auto Power Off function

If no tasks are performed for a while\* when shooting, viewing images, or setting up the camera while using the batteries, power is automatically shut off to preserve battery power.

However, in the following circumstances, even if the batteries are being used to power the camera, the Auto Power Off function will not work.

- Movies are being played back
- A slide show is being shown
- A cable is connected to the (USB) jack or the A/V OUT (MONO) jack

- \* When [Power Save] is set to [On]:  
approximately 90 seconds  
When [Power Save] is set to [Off]:  
approximately three minutes

## How to use the control button

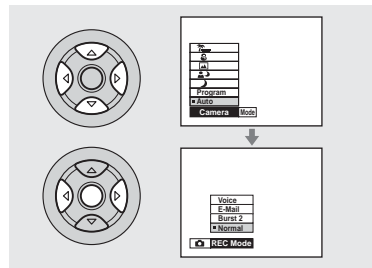



To change the current settings of the camera, bring up the menu or the SET UP screen (page 45), and use the control button to make the changes.

For each item, press /// to select the desired value, then press or to make the setting.

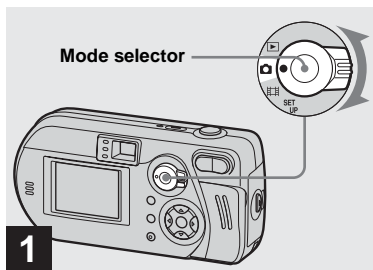
## Setting the date and time



➔ Set the mode selector to .

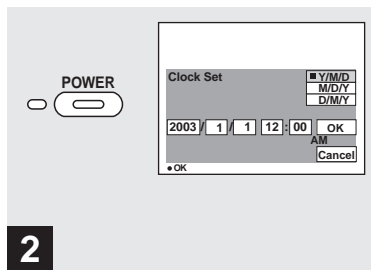

- You can carry out this operation even when the mode selector is set to  or .
- To set the time and the date again, set the mode selector to SET UP, select [Clock Set] in  (Setup 1) (pages 45, 107), then proceed from Step **3**.

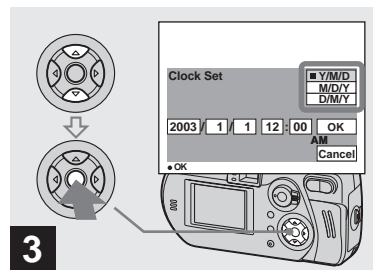

➔ Press **POWER** to turn on the camera.

The POWER lamp lights in green and the Clock Set screen appears on the LCD screen.



➔ Select the desired date format with / on the control button, then press .

You can select from [Y/M/D] (year/month/day), [M/D/Y], and [D/M/Y].

- If the rechargeable button battery, which provides the power for saving the time data, ever loses its charge (page 109), the Clock Set screen automatically reappears. If this happens, start from Step **3** to set up the date and time again.

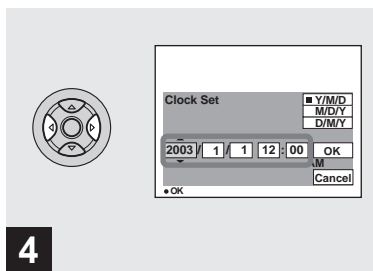

**4** → Select the year, month, day, hour, or minute item you want to set with ◀/▶ on the control button.

▲ is shown above and ▼ is shown below the selected item.

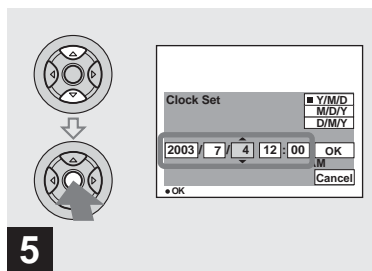

**5** → Set the desired numerical value with ▲/▼ on the control button, then press ●.

After setting the current numerical value, set the next item. Repeat the above process until all of the items have been set.

- If you select [D/M/Y] in Step **3**, set the time on a 24- hour cycle.

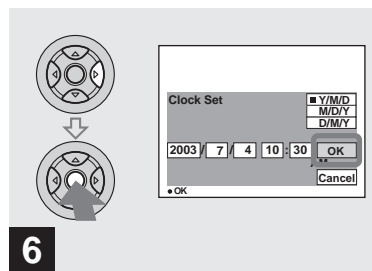

**6** → Select [OK] with ▶ on the control button, then press ●.

The date and time are set and the clock will start to keep time.

- To cancel the setting process, select [Cancel], then press ●.

## Inserting and removing a "Memory Stick"

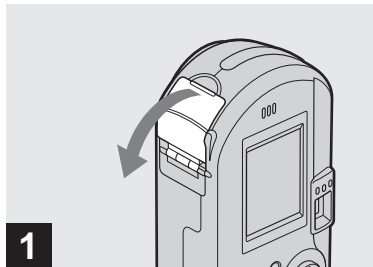

### ➔ Open the "Memory Stick" cover.

Slide the cover in the direction of the arrow.

- For more information about the "Memory Stick," see page 109.

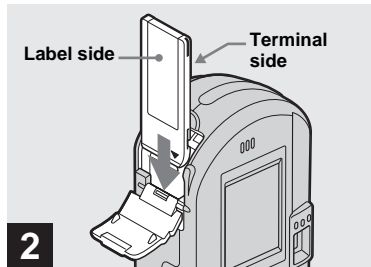

### ➔ Insert the "Memory Stick."

Insert the "Memory Stick" all the way in until it clicks as shown in the illustration.

- Whenever you insert a "Memory Stick," push it as far as it can go. If you do not insert it correctly, a proper recording or playback may not be carried out.

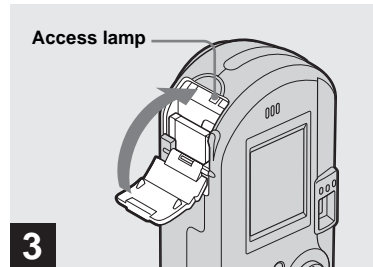

### ➔ Close the "Memory Stick" cover.

#### To remove the "Memory Stick"

Open the "Memory Stick" cover, then push the "Memory Stick" to pop it out.

- Whenever the access lamp is lit, the camera is recording or reading out an image. Never remove the "Memory Stick" or turn off the power at this time. The data may be corrupted.

## Setting the still image size

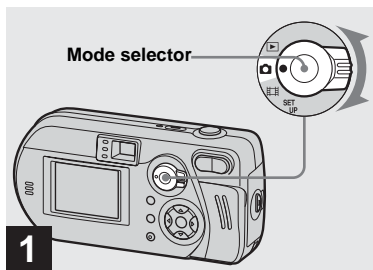

**1** → Set the mode selector to .

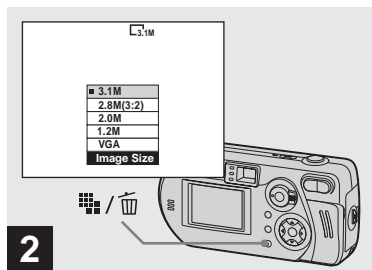



**2** → Turn on the camera, then press  /  (Image Size).

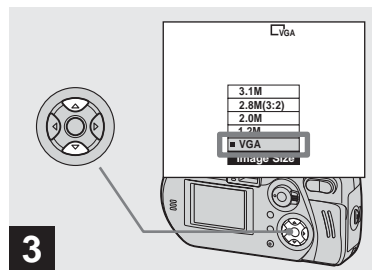

The Image Size setup item appears.

- For more information about the image size, see page 25.



**3** → Select the desired image size with  /  on the control button.

The image size is set.

After the setting is completed, press  /  (Image Size). The Image Size setup item disappears from the screen.

- The image size value selected here is preserved even when the camera is turned off.



## Image size and quality

You can choose image size (number of pixels) and image quality (compression ratio) based on the kind of images you want to shoot. The larger you make the image size and the higher you make the image quality, the better your image, but also the larger the amount of data needed to preserve your image. This means you can save fewer images in your “Memory Stick.”

Choose an image size and quality level appropriately for the kind of images you want to shoot.

You can resize the images later (Resize function, see page 69).

You can choose an image size from among the five options in the following tables. The image sizes shown below show minimum settings as examples. When you want to improve image quality, select a larger image size.

Image size	Examples	
3.1M	2048×1536	Printing A4 size images
2.8M (3:2)	2048(3:2)	3:2 prints <sup>1)</sup>
2.0M	1632×1224	Printing A5 size images
1.2M	1280×960	Printing postcard size images
VGA	640×480	Creating your home page

<sup>1)</sup>This option records images in a horizontal to vertical proportion of 3:2 to match the size of the print paper used.

### The number of images that can be saved in a “Memory Stick”<sup>2)</sup>

The number of images that can be saved in Fine (Standard)<sup>3)</sup> mode are shown below. (Units: number of images)

Capacity Image size	16MB	32MB	64MB	128MB	MSX-256	MSX-512	MSX-1G
3.1M	10 (18)	20 (37)	41 (74)	82 (149)	148 (264)	302 (537)	617 (1097)
2.8M (3:2)	10 (18)	20 (37)	41 (74)	82 (149)	148 (264)	302 (537)	617 (1097)
2.0M	16 (30)	33 (61)	66 (123)	133 (246)	238 (446)	484 (907)	988 (1852)
1.2M	24 (46)	50 (93)	101 (187)	202 (376)	357 (649)	726 (1320)	1482 (2694)
VGA	97 (243)	196 (491)	394 (985)	790 (1975)	1428 (3571)	2904 (7261)	5928 (14821)

<sup>2)</sup>When [REC Mode] is set to [Normal]

For the number of images that can be saved in other modes, see page 101.

<sup>3)</sup>For more information about the image quality mode, see page 46.

- “3.2MEGA PIXELS” shown on the surface of the camera is the number of effective pixels of the CCD. However, the maximum number of pixels recorded is 3.1 mega pixels.
- When the images recorded using other Sony devices are played back, the image size indication may be different from the actual image size.

- When the images are viewed on the LCD screen of the camera, they all look the same size.
- Number of shooting images can differ from these values according to shooting conditions.
- When the remaining number of images recordable is more than 9999, “>9999” is indicated.

## Basic still image shooting - using auto mode

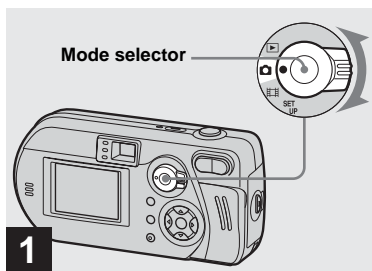

➔ **Set the mode selector to , and turn on the camera.**

The recording folder name is indicated on the LCD screen for about five seconds.

- The lens cover opens when the power is turned on.
- Do not touch the lens portion while it is operating, such as when you press POWER to turn on the power or when the zoom function is working (DSC-P72 only) (page 29).
- You can create a new folder in the “Memory Stick” and select the folder for storing images (page 46).

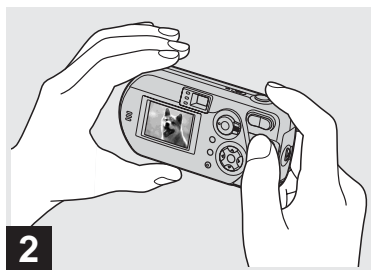

➔ **Hold the camera steadily with both hands and position a subject in the center of the focus frame.**

Do not cover the lens, flash, or microphone with your fingers.

- The minimum focal distance to a subject is as follows:  
DSC-P72: 50 cm (19 <sup>3</sup>/<sub>4</sub> inches)  
DSC-P52: 8 cm (3 <sup>1</sup>/<sub>4</sub> inches) (W)/40 cm (15 <sup>3</sup>/<sub>4</sub> inches) (T)  
DSC-P32: 10 cm (4 inches)  
To shoot subjects at distances closer than this, use the macro mode (DSC-P72 only) (page 30).



➔ **Press and hold the shutter button halfway down.**

The camera beeps. When the AE/AF lock indicator stops flashing and remains on, the camera is ready for shooting. (The screen may be frozen for a split second depending on the subject.)

- If you release your finger from the shutter button, shooting will be canceled.
- When the camera does not beep, the AF adjustment is not complete. You can continue to shoot, but the focus is not set properly.
- The frame indicated on the LCD screen shows the focus adjustment range. (AF range finder, see page 48.)





➔ **Press the shutter button fully down.**

The shutter clicks, the shooting is completed, and the still image is saved in the “Memory Stick.” When the recording lamp (pages 9, 11, 13) goes out, you can shoot the next image.

- When you are shooting with the batteries, if no tasks are performed for a while with the camera turned on, power is automatically shut off to preserve battery power (page 20).

## The position on the mode selector

When the mode selector is set to , the functions that can be selected change according to the  (Camera) setting in the menu settings as follows:

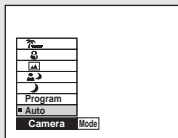

### Auto mode shooting [Auto]

You can shoot your subject easily since this mode automatically adjusts the focus, exposure, and white balance. In this mode, [Mode] is set to [Fine], the AF range finder is set to [Multi AF], and the metering mode is set to multi-pattern metering (pages 48, 51). The menu items you can display are limited to  (Camera) and [Mode] (REC Mode).

### Program mode shooting [Program]

You can set the shooting functions in the menu settings according to your shooting condition.

### Twilight mode []

See page 58.

### Twilight portrait mode [ ]

See page 58.

### Landscape mode []

See page 58.



### Snow mode []

See page 58.

### Beach mode []

See page 58.

## To change the camera mode

- 1 Set the mode selector to .
- 2 Press MENU.
- 3 Select  (Camera) with ◀ on the control button.
- 4 Select the desired camera mode with ▲/▼ on the control button.

## About Auto Focus

When you try to shoot a subject that is hard to focus on, the AE/AF lock indicator will change to flashing slowly.

The Auto Focus function may be difficult to use with in the following subjects. In such cases, release the shutter button, then try to recompose the shot and focus again.

- The subject is distant from the camera and dark
- The contrast between the subject and its background is poor
- The subject is seen through glass, such as a window
- A fast-moving subject
- The subject has a reflection, such as that from a mirror, or there is a luminous body and a lustrous subject
- A flashing subject.
- A backlit subject

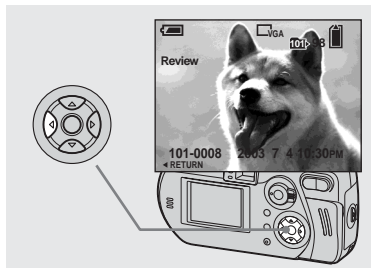

There are two methods for Auto Focus function: Multipoint AF and Center AF (page 48). When [CAMERA] (Camera) is set to [Auto] in the menu settings, the Multipoint AF is automatically selected.



➔ Press ◀ (◀) on the control button.

To return to shooting mode, press the shutter button lightly or press ◀ (◀) on the control button again.

**To delete the image displayed on the LCD screen**

- 1 Press  /  (Delete).
- 2 Select [Delete] with ▲ on the control button, then press ●.  
The image is deleted.

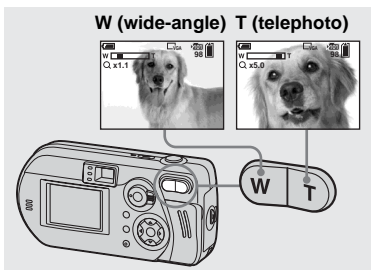

➔ Press the zoom buttons to choose the desired zoom position, and shoot your image.

### The minimum distance needed to focus on a subject

Approximately 50 cm (19 <sup>3</sup>/<sub>4</sub> inches) from the end of the lens (DSC-P72)

Approximately 8 cm (3 <sup>1</sup>/<sub>4</sub> inches) (W)/  
40 cm (15 <sup>3</sup>/<sub>4</sub> inches) (T) from the end of the lens (DSC-P52)

Approximately 10 cm (4 inches) from the end of the lens (DSC-P32)

- The lens moves when the zoom feature is being used (DSC-P72 only). Be very careful not to touch the lens.
- You cannot change the zoom scaling while shooting movies (page 72).

## Smart zoom

You can zoom in on the image using a digital zoom process with no deterioration in the image quality.

The maximum zoom scale depends on the image size.

	DSC-P72	DSC-P52	DSC-P32
2.0M	3.8×	2.5×	1.3×
1.2M	4.8×	3.2×	1.6×
VGA	9.6×	6.4×	3.2×

When the image size is [3.1M] or [2.8M (3:2)], the smart zoom does not work.

### DSC-P72/DSC-P52

When the zoom exceeds 3× (DSC-P72) or 2× (DSC-P52), enlargement is carried out using the smart zoom. When the smart zoom is not needed, set [Smart Zoom] to [Off] in the SET UP settings (page 106). Pressing the zoom buttons displays the zoom scaling indicator on the LCD screen.

### Zoom scaling indicator

The T side of this line shows the extent of smart zoom

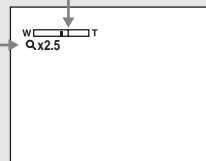

### DSC-P32

The DSC-P32 does not have an optical zoom. It has only the smart zoom.

- You cannot confirm the image using the finder when using the smart zoom function.
- When using the smart zoom, the image on the LCD screen may look rough. However, this phenomenon has no effect on the recorded image.
- AF range finder is not shown when using the smart zoom. When  $\text{AF}$  (Focus) is set to [Multi AF] or [Center AF],  $\text{AF}$  or  $\text{AF}$  flashes and the centrally-located subject has priority to focus on.

## Shooting close-ups – Macro (DSC-P72 only)



For close-ups of small subjects like flowers or insects, shoot using the macro feature. You can use this feature for close-ups of subjects up to the distances specified below.

**When the zoom is set all the way to the W side:** 10 cm (4 inches) from the end of the lens

**When the zoom is set all the way to the T side:** 50 cm (19 <sup>3</sup>/<sub>4</sub> inches) from the end of the lens

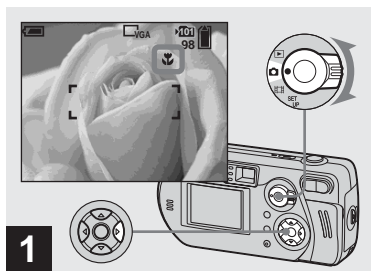

**1** → Set the mode selector to , and press  on the control button.

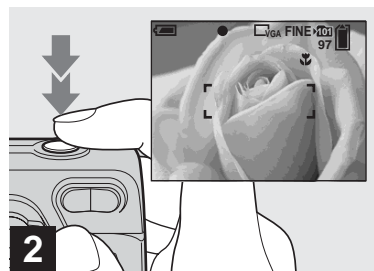

The  (Macro) indicator appears on the LCD screen.

- If the menu is currently displayed, press MENU first to make the menu disappear.
- You can carry out this operation even when the mode selector is set to .





**2** → Center the subject in the frame, and press the shutter button fully down.

### To return to normal shooting

Press  on the control button again. The  indicator disappears from the LCD screen.

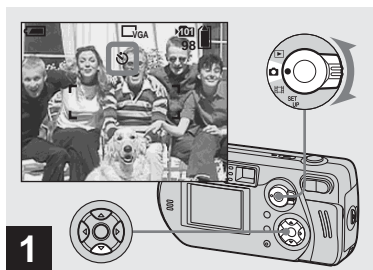
- Use the LCD screen to shoot when using the macro feature. If you use the finder, the limits of what you see and what you actually shoot may be different.



- ➔ **Set the mode selector to , and press  on the control button.**

The  (Self-timer) indicator appears on the LCD screen.

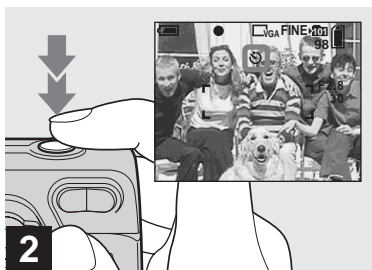

- If the menu is currently displayed, press MENU first to make the menu disappear.
- You can carry out this operation even when the mode selector is set to .



- ➔ **Center the subject in the frame, and press the shutter button fully down.**



The Self-timer lamp (pages 8, 10, 12) will flash in orange, and you will hear a beeping sound. The image will be shot after approximately 10 seconds.

### **To cancel the self-timer during the operation**

Press  on the control button again. The  indicator disappears from the LCD screen.

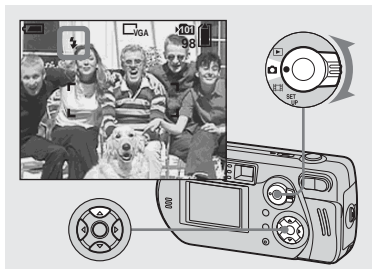
- If you stand in front of the camera and press the shutter button, the focus and the exposure may not be correctly set.





➔ **Set the mode selector to , and press  (⏏) on the control button repeatedly to select a flash mode.**





The flash mode has the following features.

**No indicator (Auto):** The camera decides to use the flash based on lighting conditions. The flash will be used when there is not enough light or when shooting a subject against a light source.

** (Forced flash):** The flash will be used regardless of the amount of ambient light.

** (Slow synchro):** The flash will be used regardless of the amount of ambient light. In this mode, the shutter speed is slower under dark conditions, so you can clearly shoot a background that is out of the flash-lit area.

** (No flash):** The flash will not be used.

- If the menu is currently displayed, press MENU first to make the menu disappear.
- You can carry out this operation even when the mode selector is set to  (Clip motion).
- The recommended distance using the flash is as follows (when [ISO] is set to [Auto]):
  - About 0.5 m to 3.8 m (19 <sup>3</sup>/<sub>4</sub> inches to 12 feet 5 <sup>19</sup>/<sub>32</sub> inches) (W)/0.5 m to 2.5 m (19 <sup>3</sup>/<sub>4</sub> inches to 8 feet 2 <sup>7</sup>/<sub>16</sub> inches) (T) (DSC-P72).
  - About 0.5 m to 3.3 m (19 <sup>3</sup>/<sub>4</sub> inches to 10 feet 9 <sup>29</sup>/<sub>32</sub> inches) (DSC-P52).
  - About 0.5 m to 3.8 m (19 <sup>3</sup>/<sub>4</sub> inches to 12 feet 5 <sup>19</sup>/<sub>32</sub> inches) (DSC-P32).
- You can change the brightness of the flash using [Flash Level] in the menu settings (page 103).
- Because the shutter speed is slower under dark conditions when  (Slow synchro) or  (No flash) is selected, it is recommended that you use a tripod.
- While the flash is being charged, the  lamp flashes. After charging is completed, the lamp goes out.
- The flash mode selected here is preserved even when the camera is turned off.

## When shooting against a light source

In Auto mode, shooting against a light source automatically flashes even when there is enough light around the subject. (Daylight synchro)

Before flashed



When flashed



- The best performance may not be given depending on shooting conditions.
- When you do not want to use the flash, set the flash mode to  (No flash).



## To reduce “red-eye” when shooting live subjects

The flash pre-strobes before shooting to reduce the red-eye phenomenon. Set [Red Eye Reduction] to [On] in the SET UP settings (page 106).  appears on the LCD screen.



- The amount of red-eye reduction possible varies according to the individual. In addition, the distance to the subject, and whether or not the subject has seen pre-strobe light begin to strobe may also reduce the effectiveness of the red-eye reduction process.

## Shooting with the AF illuminator

This is additional lighting provided to assist in focusing when shooting in dark places. Set [AF Illuminator] to [Auto] in the SET UP settings (page 106). If you try to shoot under insufficient lighting conditions,  appears on the LCD screen; the AF illuminator will emit a red light automatically during the time between when the shutter button is pressed halfway down and the focus locks.

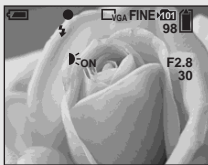







- Even when the AF illuminator flashes, but sufficient light does not reach the subject\*, or the subject has weak contrast, the camera may not focus properly.

\* The recommend distance for this feature is as follows:

DSC-P72: Up to approximately 3.8 m (12 feet 5 <sup>19</sup>/<sub>32</sub> inches) (W)/Up to approximately 2.5 m (8 feet 2 <sup>7</sup>/<sub>16</sub> inches) (T)

DSC-P52: Up to approximately 3.3 m (10 feet 9 <sup>29</sup>/<sub>32</sub> inches)

DSC-P32: Up to approximately 2.5 m (8 feet 2 <sup>7</sup>/<sub>16</sub> inches)

- If AF illuminator light misses the center of the image somewhat, the camera will focus properly as long as it reaches the subject.
- When the focus preset distance is set (page 49), the AF illuminator does not function.
- When  (Focus) is set to [Multi AF] or [Center AF], the AF range finder is not displayed.  or  flashes and the centrally-located subject has priority to focus on.
- When  (Camera) is set to one of the following items in the menu settings, the AF illuminator will not function (page 58).
  - When shooting in  Twilight mode
  - When shooting in  Landscape mode
- The AF illuminator is a bright light. There are no safety hazards, but when shooting at short distances, do not aim it directly at the subject's eyes.

## Shooting with the finder

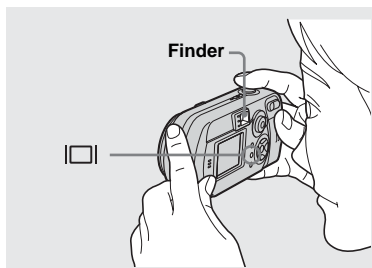

The finder is convenient when you want to save battery power, or when it is difficult to confirm the image using the LCD screen. Each time you press , the display changes in the following order.





**All of the indicators are turned off**



**The LCD screen is turned off.**

**All of the available indicators are turned on.**



- The image through the finder does not indicate the actual recordable range. To confirm the recordable range, use the LCD screen.
- For details on the items displayed, see page 113.
- Just as with the AE/AF lock indicator on the LCD screen, when the AE/AF lock lamp of the finder section stops flashing and remains on, you can start shooting (page 26).
- When the LCD screen is turned off, the smart zoom does not function (page 29).
- If you press  (Flash mode) /  (Self-timer) /  (Macro) (DSC-P72) or  (Spot meter) (DSC-P52/P32) with the LCD screen turned off, the image will be displayed on the screen for approximately two seconds so you can check or change the setting.

- This setting is maintained even when the power is turned off.

## Inserting the date and time on a still image

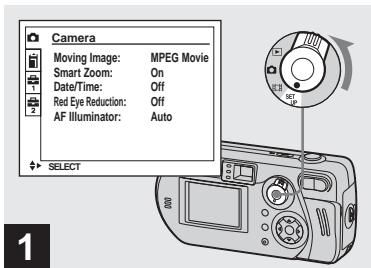

➔ Set the mode selector to SET UP.

The SET UP screen appears.

- When images are shot with the date and time inserted, the date and time cannot be removed later.
- When shooting images with the date and time inserted, the actual date and time are not displayed on the LCD screen, and **DATE** is displayed in the upper-left portion of the LCD screen instead. The actual date and time are indicated in red on the lower-right corner when the image is played back.

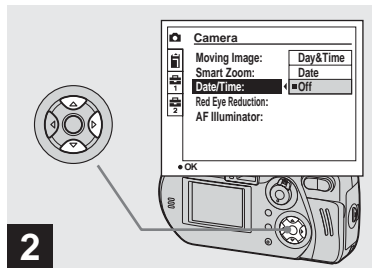

➔ Select (Camera) with ▲ on the control button, then press



Select [Date/Time] with ▲/▼, then press .

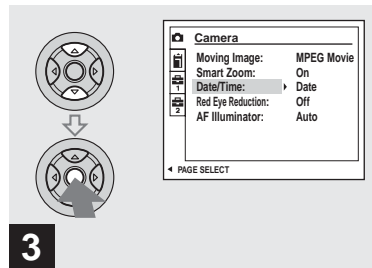

➔ Select the date and time setting with ▲/▼ on the control button, then press ●.

**Day&Time:** Inserts the date and the time of shooting into the image

**Date:** Inserts the year, the month and the date of shooting into the image

**Off:** Does not insert date/time data into the image

After the setting has been completed, set the mode selector to to shoot your image.

- When you chose [Date], the date will be inserted in the order set in “Setting the date and time” (page 21).
- This setting is maintained even when the power is turned off.

## Viewing images on the LCD screen of your camera

### Single (single-image) screen



You can view images shot with the camera almost immediately on the screen. You can select the following three methods for viewing images.

### Single (single-image) screen

You can view one image at a time, occupying the entire screen.

### Index (nine-image) screen

Nine images are displayed simultaneously in separate panels on the screen.

### Index (triple-image) screen

Three images are displayed simultaneously in separate panels on the screen. Various image information items are also displayed.

### Index (nine-image) screen

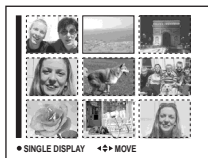

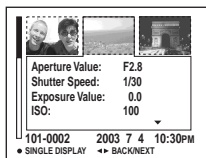

### Index (triple-image) screen

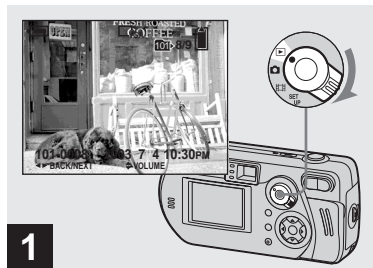

- For details on the movies, see page 73.
- For a detailed description of the screen indicators, see page 115.

## Viewing on the single-image screen



➔ **Set the mode selector to , and turn on the camera.**

The newest image in the selected recording folder (page 47) is displayed.

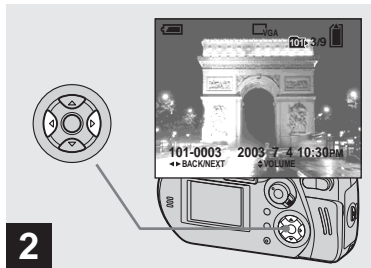

➔ Select the desired still image with ◀/▶ on the control button.

- ◀ : Displays the previous image.
- ▶ : Displays the next image.

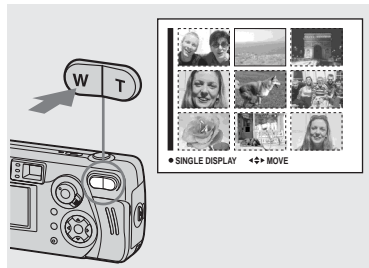

➔ Press the zoom W (index) button once.

The display switches to the **Index (nine-image) screen**.

**To display the next (previous) Index screen**

Press ▲/▼/◀/▶ on the control button to move the yellow frame up/down/left/right.

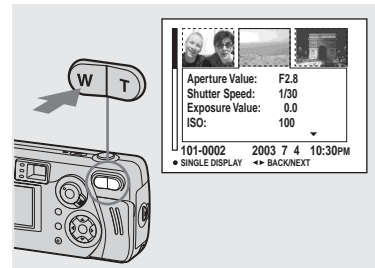

➔ Press the zoom W (index) button once more.

The display switches to the **Index (triple-image) screen**.

Pressing ▲/▼ on the control button shows the remaining image information.

**To display the next (previous) Index screen**

Press ◀/▶ on the control button.

**To return to the single-image screen**

Press the zoom T button repeatedly, or press ● on the control button.

## Viewing images on a TV screen

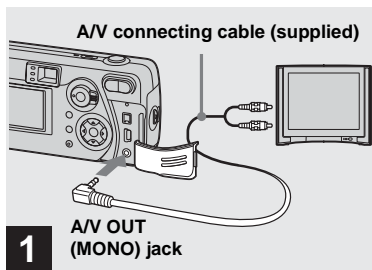

- ➔ **Connect the supplied A/V connecting cable to the A/V OUT (MONO) jack of the camera and the audio/video input jacks of the TV.**

If your TV has stereo type input jacks, connect the audio plug (black) of the A/V connecting cable to the Lch audio input jack.

- Turn off both the camera and the TV before connecting the camera and the TV with the A/V connecting cable.

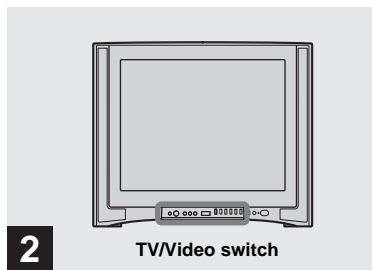

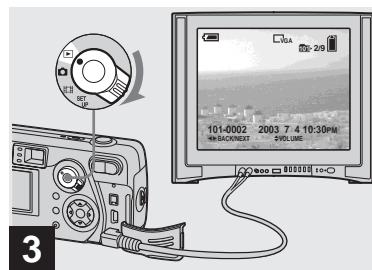

- ➔ **Turn on the TV, and set the TV/Video switch to “Video.”**

- The name and location of this switch may differ depending on your TV. For details, refer to the operating instructions supplied with the TV.



- ➔ **Set the mode selector to , and turn on the camera.**

Press   on the control button to select the desired image.

- When using the camera abroad, it may be necessary to switch the video output signal to match that of your TV system (page 107).

**Watching images on a TV screen**

If you want to view images on a TV, you need a TV having a video input jack and the A/V connecting cable (supplied).

The color system of the TV must match as that of your digital still camera. Check the following list:

**NTSC system**

Bahama Islands, Bolivia, Canada, Central America, Chile, Colombia, Ecuador, Jamaica, Japan, Korea, Mexico, Peru, Surinam, Taiwan, the Philippines, the U.S.A., Venezuela, etc.

**PAL system**

Australia, Austria, Belgium, China, Czech Republic, Denmark, Finland, Germany, Holland, Hong Kong, Italy, Kuwait, Malaysia, New Zealand, Norway, Portugal, Singapore, Slovak Republic, Spain, Sweden, Switzerland, Thailand, United Kingdom, etc.

**PAL-M system**

Brazil

**PAL-N system**



Argentina, Paraguay, Uruguay

**SECAM system**

Bulgaria, France, Guiana, Hungary, Iran, Iraq, Monaco, Poland, Russia, Ukraine, etc.

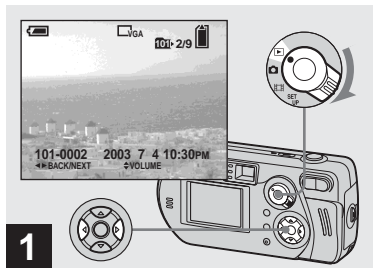
## Deleting images



- Set the mode selector to , and turn on the camera. Select the image you want to delete with / on the control button.

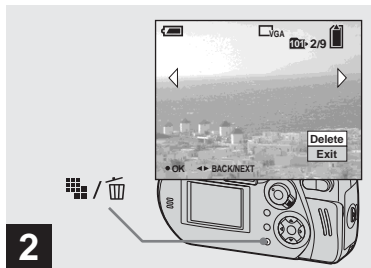

- Press  /  (Delete).

The image has not yet been deleted at this point.



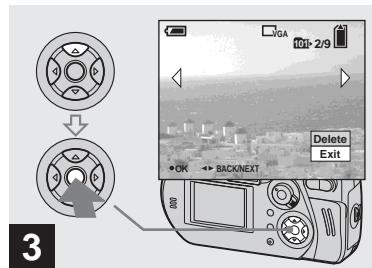

- You cannot delete protected images (page 67).





- Select [Delete] with  on the control button, then press .

“Memory Stick access” appears on the screen. When this message disappears, the image has been deleted.

### To delete other images continuously

Select the image you want to delete with / on the control button. Next, select [Delete] with  on the control button, then press .

### To cancel the deletion

Select [Exit] with  on the control button, then press .





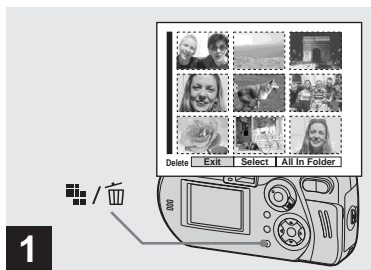

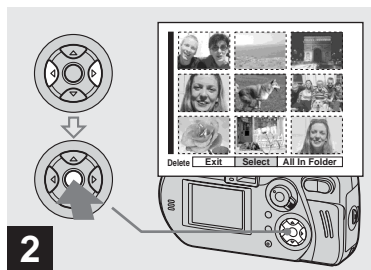

## Deleting on the Index (nine-image) screen





→ While an Index (nine-image) screen (page 37) is displayed, press  (Delete).





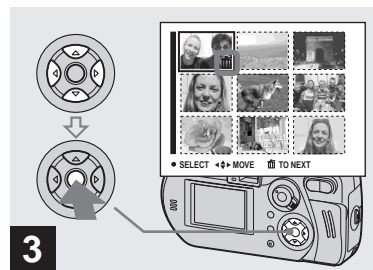

→ Select [Select] with  on the control button, then press .

To delete all the images in the folder Select [All In Folder] with  on the control button, then press . Next, select [OK], then press . All of the unprotected images in the folder are deleted. To cancel the deletion, select [Cancel], then press .







→ Select the image you want to delete with  on the control button, then press .

The  (Delete) mark is indicated on the selected image. The image has not yet been deleted at this point. Put the  mark on all of the images you want to delete.

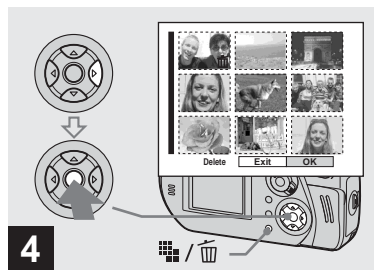
- To cancel your selection, select images you want to cancel and press  again. The  mark disappears.



## Deleting on the Index (nine-image) screen (continued)



- Press  /  (Delete).  
Select [OK] with  on the control button, then press .



“Memory Stick access” appears on the screen. When this message disappears, all of the images with  marks have been deleted.

### To cancel the deletion

Select [Exit] with  on the control button, then press .

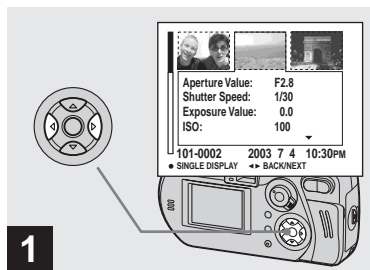
## Deleting on the Index (triple-image) screen



- While an Index (triple-image) screen (page 37) is displayed, move the image you want to delete to the center with  /  on the control button.

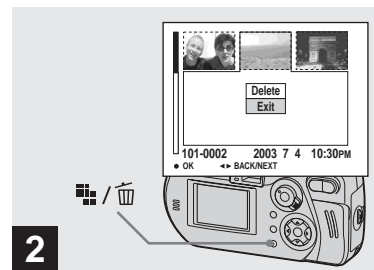

- Press  /  (Delete).

The image has not yet been deleted at this point.

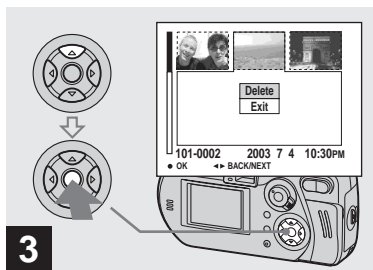

➔ **Select [Delete] with ▲ on the control button, then press ●.**

“Memory Stick access” appears on the screen. When this message disappears, the image has been deleted.

#### **To cancel the deletion**

Select [Exit] with ▼ on the control button, then press ●.

## Formatting a “Memory Stick”

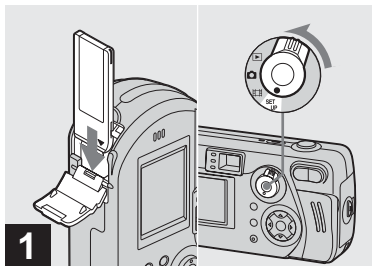

- 1** → Insert the “Memory Stick” you want to format into the camera. Set the mode selector to **SET UP**, and turn on the camera.

- The term “formatting” means preparing a “Memory Stick” to record images; this process is also called “initialization.” The supplied “Memory Stick” and those available commercially, are already formatted, and can be used immediately.
- **When you format a “Memory Stick,” be aware that all of the data in the “Memory Stick” will be permanently erased. Protected images are also erased.**

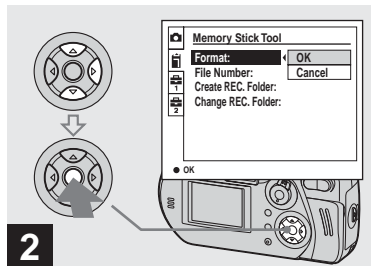

- 2** → Select **[Format]** with **▲/▼** on the control button. Select **[Format]** with **▶**, then, press **▶**. Select **[OK]** with **▲**, then press **●**.

### To cancel the formatting

Select **[Cancel]** with **▼** on the control button, then press **●**.

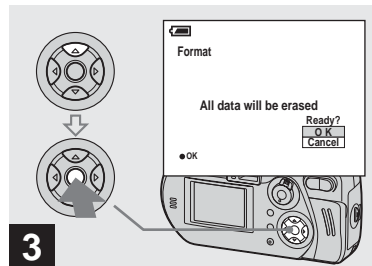

- 3** → Select **[OK]** with **▲** on the control button, then press **●**.

The “Formatting” message appears on the screen. When this message disappears, the format is complete.

## How to setup and operate your camera

This section describes the most frequently used menus and the SET UP screen.

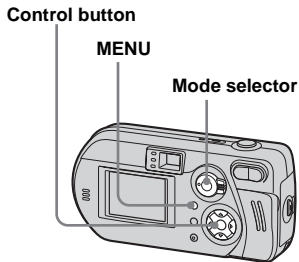

### Changing menu settings

#### 1 Press MENU.

The menu appears.

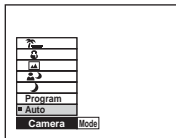

#### 2 Select the setting item you want to change with ◀/▶ on the control button.

The letters and symbols of the item you select turn yellow.

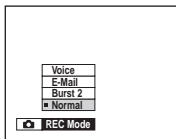

#### 3 Select the desired setting with ▲/▼ on the control button.

The frame of the selected setting turns yellow, and the setting is entered.

### To turn off the menu display

Press MENU.

### Changing items in the SET UP screen

#### 1 Set the mode selector to SET UP.

The SET UP screen appears.

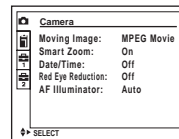

#### 2 Select the setting item you want to change with ▲/▼/◀/▶ on the control button.

The frame of the item you select turns yellow.

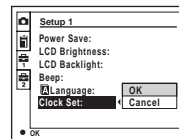

#### 3 Press ● on the control button to enter the setting.

### To turn off the SET UP screen display

Set the mode selector to any position other than SET UP.

## Deciding the still image quality

### Mode selector:

You can select the still image quality from [Fine] or [Standard].

### Before operation

Set  (Camera) to any mode other than [Auto] in the menu settings (page 27).

#### Control button

MENU



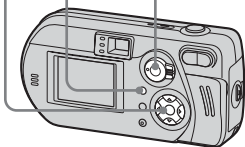

Mode selector





**1** Set the mode selector to .

**2** Press MENU.

The menu appears.

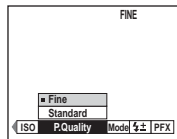
**3** Select  (P. Quality) with , then select the desired image quality with /.



- You can carry out this operation even when the mode selector is set to  (Multi Burst).
- The image quality value selected here is preserved even when the camera is turned off.

## Creating or selecting a folder

### Mode selector: SET UP

Your camera can create multiple folders within a “Memory Stick.” You can select the folder used to store images. When not creating a new folder, “101MSDCF” folder is selected as the recording folder. You can create folders up to “999MSDCF.”

#### Control button

MENU

Mode selector

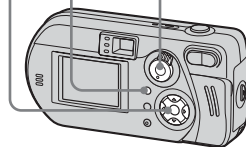

- Up to 4000 images can be stored in one folder. When the folder capacity is exceeded, a new folder is automatically created.

## Creating a new folder

- 1** Set the mode selector to SET UP.
- 2** Select  (Memory Stick Tool) with  $\blacktriangle/\nabla$ , [Create REC. Folder] with  $\blacktriangleright/\blacktriangleleft/\nabla$ , and [OK] with  $\blacktriangleright/\blacktriangleleft$ , then press  $\bullet$ .

The following screen appears.



- 3** Select [OK] with  $\blacktriangle$ , then press  $\bullet$ .

A new folder is created with a number one higher than the largest number in the “Memory Stick,” and the folder becomes the recording folder.

## To cancel folder creation

Select [Cancel] in step **2** or **3**.

- Once you create a new folder, you cannot delete the new folder with the camera.
- Recorded images are recorded in the newly created folder until a different folder is created or selected.

## Selecting the recording folder

- 1** Set the mode selector to SET UP.
- 2** Select  (Memory Stick Tool) with  $\blacktriangle/\nabla$ , [Change REC. Folder] with  $\blacktriangleright/\blacktriangleleft/\nabla$ , and [OK] with  $\blacktriangleright/\blacktriangleleft$ , then press  $\bullet$ .

The recording folder selection screen appears.

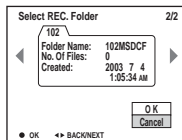

- 3** Select the desired folder with  $\blacktriangleleft/\blacktriangleright$ , and [OK] with  $\blacktriangle$ , then press  $\bullet$ .

## To cancel changing the recording folder

Select [Cancel] in step **2** or **3**.

- You cannot select the “100MSDCF” folder as a recording folder.
- The image is stored in the newly selected folder. You cannot move images to other folders using the camera.

## Choosing a focus method

Mode selector:  

### Multipoint AF

The camera calculates the distance in three areas to the left, and right and in the center of the image, letting you shoot using the auto focus function without worrying about the image composition. This is useful when it is difficult to focus on the subject because it is not in the center of the frame. The AF range finder that was used changes to green after the focus is achieved.

### Center AF



The AF range finder is only the center of the frame. You can shoot in desired image composition using the AF lock method.

### Before operation

When shooting still images, set  (Camera) to any mode other than [Auto] in the menu settings (page 27).

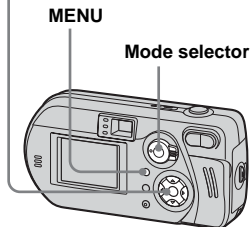



Control button



**1** Set the mode selector to  or .

**2** Press MENU.

The menu appears.

**3** Select  (Focus) with / , then select [Multi AF] or [Center AF] with / .

The focus is adjusted automatically.

The color of the AF range finder frame changes from white to green.

### Multipoint AF

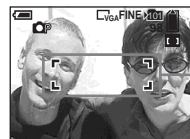



AF range finder

### Center AF



AF range finder

- When you are shooting movies (MPEG movie) and you choose Multipoint AF, the distance to the center of the screen is estimated as an average, so the AF works even with a certain amount of vibration. The Center AF automatically focuses only on the center of the image, so it is convenient when you want to focus only on what you aim at.
- When you use the smart zoom or AF illuminator, priority AF movement is given to subjects in or near the center of the frame. In this case,  or  flashes and the AF range finder is not displayed.



## Shooting techniques

Even if it is difficult to focus in AF shooting because the subject is not in the center of the frame, you can focus in this situation using Center AF. For example, when you are shooting two subjects, and there is a gap between them, the camera may focus on the background visible in the gap. In a case like this, use AF lock to ensure the subjects are in correct focus.

Compose the shot so that the subject is centered in the AF range finder, and press the shutter button halfway down.

When the AE/AF lock indicator stops flashing and remains on, return to the fully composed shot, and press the shutter button fully down.

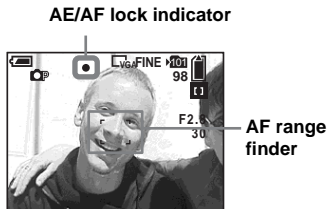

- When you are using AF lock, you can capture an image with the correct focus even if the subject is at the edge of the frame.
- You can carry out the AF lock adjustment process before you press the shutter button fully down.

## Setting the distance to the subject

### – Focus preset

**Mode selector:**

When shooting an image using a previously set distance to the subject, or when shooting a subject through a net or through window glass, it is difficult to get the proper focus in auto focus mode. In these cases, use of the Focus preset is convenient.

### Before operation

When shooting still images, set (Camera) to any mode other than [Auto] in the menu settings (page 27).

### Control button

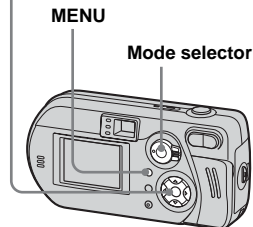

**1** Set the mode selector to or .

**2** Press MENU.

The menu appears.

**3** Select (Focus) with / , then select the distance to the subject with / .

You can select from the following distance settings.

0.5m, 1.0m, 3.0m, 7.0m, ∞ (unlimited distance)

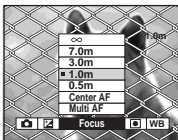

## To return to auto focus mode

In step **3**, select (Focus), then select [Multi AF] or [Center AF].

- (Metering Mode) is not displayed on the menu of the DSC-P52/P32.
- Focal point information may not show the exact distance. Use it as a guide.
- If you point the lens up or down, the error increases (DSC-P72 only).

## Adjusting the exposure

### – EV adjustment

**Mode selector:** /

Used when you want to change the automatic exposure to one of your own choice. The value can be set a range from +2.0EV to –2.0EV, in 1/3EV increments.

### Before operation

When shooting still images, set (Camera) to any mode other than [Auto] in the menu settings (page 27).

Control button

MENU

Mode selector

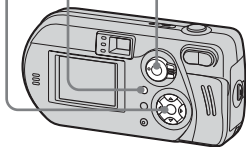

**1** Set the mode selector to or .

**2** Press MENU.

The menu appears.

**3** Select (EV) with / .

The value of the exposure adjustment is displayed.

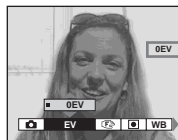

**4** Select the exposure adjustment value.

Select the exposure adjustment value with / .

Make your adjustment while confirming the brightness of the background of the subject on the LCD screen.

## To return to auto adjust mode

Return the exposure adjustment value to 0EV.

- (Metering Mode) is not displayed on the menu of the DSC-P52/P32.
- When the subject is extremely bright or extremely dark, or when you are using the flash, the adjustment may not work.

## Shooting techniques

In normal shooting, the camera makes automatic exposure adjustments. Check the image to be shot, if it looks like the image below, you should make manual adjustments.

If you are shooting a back-lit person or a snowy scene, make your adjustments in the + direction; if you are shooting a dark subject that fills the screen, making your adjustments in the - direction should give the best results.



**Underexposed**

→ Adjust in the + direction



**Appropriate exposure**



**Overexposed** → Adjust in the - direction

## Selecting a metering mode

**Mode selector:**  

This function enables you to select a metering mode to suit the shooting conditions and purpose.

### Multi-pattern metering

The image is divided into multiple regions and metering is performed for each region. The camera judges the subject position and background brightness, and determines a well-balanced exposure.

The camera is set to multi-pattern metering as the factory setting.

### Spot metering

Spot metering lets you adjust the exposure to the subject even when the subject is backlit or there is strong contrast between the subject and the background. Position the spot metering cross hair at the point you want to shoot.



**Spot metering cross hair**



## Before operation

When shooting still images, set  (Camera) to any mode other than [Auto] in the menu settings (page 27).

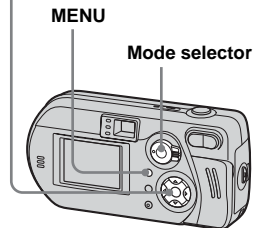



### Control button





## For the DSC-P72

- 1** Set the mode selector to  or .
- 2** Press **MENU**.  
The menu appears.
- 3** Select  (**Metering Mode**) with **◀/▶**, then select **[Multi]** or **[Spot]** with **▲/▼**.

For the DSC-P52/P32

- 1 Set the mode dial to  or .
- 2 Press  (  ) on the control button to turn spot metering on.  
The spot metering cross hair appears.

### To cancel spot metering

Press  (  ) again to turn spot metering off. The spot metering cross hair disappears, and the camera returns to multi-pattern metering.

## Adjusting color tones

### – White Balance

**Mode selector:** / 

When the white balance is set to Auto, the white balance is set automatically in response to the condition of the subject, and the overall color balance is adjusted accordingly. When you want to fix the conditions under which the image is captured, or when shooting under special lighting conditions, you can select the settings manually.

#### (Incandescent)

- Used when shooting, for example, at a party, where the lighting conditions change often.
- Used in a studio, or under video lights.

#### (Fluorescent)

Used when shooting under fluorescent lights.

#### (Cloudy)

Used when shooting under a cloudy sky.

#### (Daylight)

Used when shooting outdoors, and for shooting at night, under neon lights, for fireworks, sunrise, and twilight gloom.

### Auto (No indicator)

The white balance is adjusted automatically.

### Before operation





When shooting still images, set  (Camera) to any mode other than [Auto] in the menu settings (page 27).

Control button

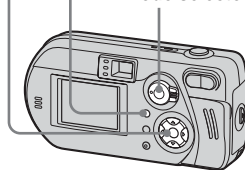
MENU

Mode selector



- 1 Set the mode selector to  or .
- 2 Press MENU.  
The menu appears.
- 3 Select [WB] (White Bal) with , then select the desired setting with / .

### To return to automatic settings

In Step **3**, select [Auto].

- Under fluorescent lights that flicker, even if you choose , the white balance may not be properly adjusted.
- When the flash is triggered, the manual setting of white balance is cancelled, and the shooting of the image is done in Auto mode.

### Shooting techniques

The color of the subject that you see will be captured according to the lighting conditions. Under the bright summer sun, everything will appear bluish, under a light sources like a light bulb, white objects will appear reddish. The human eye has an excellent ability to adjust. Even when lighting conditions change, the eye can adjust and recognize the correct color almost instantly. However, digital still cameras are greatly influenced by light. Normally, this camera adjusts automatically, but if you notice that the color of the entire image seems to be a bit unnatural when replaying an image on the LCD screen, it is recommended that you adjust the white balance.

## Adjusting the flash level

### – Flash level

#### Mode selector:

You can adjust the amount of flash light.

#### Before operation

Set  (Camera) to any mode other than [Auto] in the menu settings (page 27).

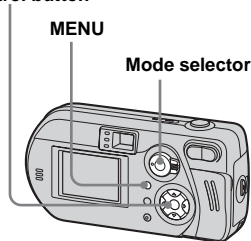

#### Control button



**1** Set the mode selector to .

**2** Press MENU.

The menu appears.

**3** Select [ $\frac{1}{2}$  ±] (Flash Level) with , then select the desired setting with .

**High:** Makes the flash level higher than normal.

**Normal:** Normal setting.

**Low:** Makes the flash level lower than normal.

- You can carry out this operation even when the mode selector is set to  (Clip Motion only).

## Shooting multiple frames

### – Clip Motion

#### Mode selector:

You can shoot a number of still images consecutively (GIF animation). Because the file size is small, these images are ideal for use on a home page, or for attaching to an e-mail message.

- Clip Motion images are restricted to color levels of 256 colors and below. This is a characteristic of GIF format recording. For this reason, the image quality of some images may deteriorate.

#### Normal (160×120)

The maximum number of frames you can shoot in one Clip Motion shot is 10. This is suitable for use on a home page.

#### Mobile (120×108)

Two frames is the maximum number that can be shot in Clip Motion in this mode. This is suitable for use with portable data terminals.

- Mobile mode has strict file size limits, so picture quality falls accordingly.

### Before operation

Set [Moving Image] to [Clip Motion] in the SET UP settings (pages 45, 106).

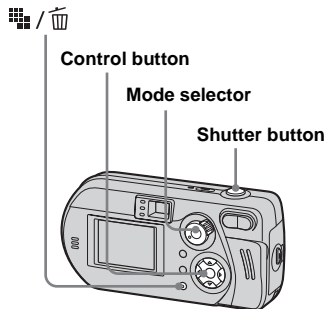

#### 1 Set the mode selector to .

#### 2 Press / (Image Size).

The Image Size setup item appears.

#### 3 Select the desired mode with / .

You can select from [Normal] or [Mobile].

#### 4 Shoot one frame.

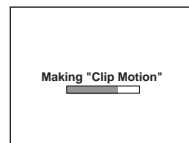





#### 5 Shoot the next frame.

Press the shutter button once to shoot the next frame, then repeat this operation until you have shot the desired number of frames.

#### 6 Press .

All of the frames will be saved in the "Memory Stick."

### To delete shot images in the midst of shooting

- 1 In Steps **4** or **5**, press  (⊖). Shot images will be played back in order, playback stops when the last image is reached.
- 2 Press  /  (Delete), and select either [Delete Last] or [Delete All], then press .
- 3 Select [Delete], then press . If you chose [Delete Last] in Step 2, repeat Steps 1 to 3 to delete the images in order, from the latest one shot.

- If you do not complete Step **6**, all the images will not be saved in the “Memory Stick.”
- In Clip Motion, the date and time cannot be inserted.
- When you view Clip Motion images using the Index screen, the images may appear different from the actual image recorded.
- GIF files made on other cameras may not be displayed correctly on this camera.
- For the number of images you can record using Clip Motion, see page 101.

## Shooting in Multi Burst mode

### – Multi Burst

**Mode selector:** 

Pressing the shutter button once records 16 frames in a row. This is convenient for checking your form in sports, for example.



### Before operation

Set [Moving Image] to [Multi Burst] in the SET UP settings (pages 45, 106).



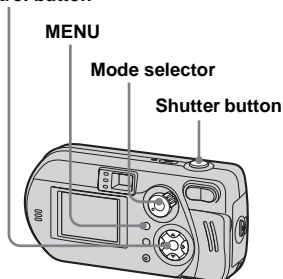

#### Control button



**1** Set the mode selector to .

**2** Press MENU.

The menu appears.

**3** Select  (Interval) with , then select the desired between-frame interval with / .

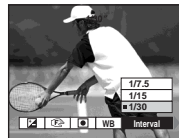

You can choose the frame interval from the menu settings (page 104).

**4** Shoot your image.

16 frames will be recorded as one image (image size: 1.2M).

-  (Metering Mode) is not displayed on the menu of the DSC-P52/P32.
- When you play back images recorded in Multi Burst mode on the camera, see page 65.
- For the number of images that can be recorded, see page 101.
- The flash cannot be used.
- In Multi Burst, the date and time cannot be inserted.

## Shooting two images in succession

### – Burst 2

**Mode selector:** 

You can shoot two images in succession while pressing the shutter button only once.

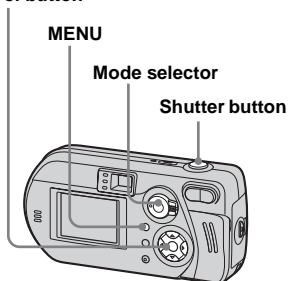

**Control button**



**1** Set the mode selector to .

**2** Press MENU.

The menu appears.

**3** Select [Mode] (REC Mode) with , then select [Burst 2] with /▼.

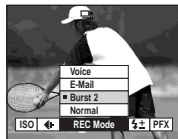

**4** Shoot your image.

You can do the next shooting after “Recording” disappears from the LCD screen.

**To return to normal mode**

In Step **3**, select [Normal].

- The flash cannot be used.
- The image is not displayed during shooting. Compose the picture before pressing the shutter button.
- The interval needed for recording is about 0.5 second.

## Shooting still images for e-mail

### – E-Mail

**Mode selector:** 

You can shoot images and save them in a file that is small enough (320×240) to attach to an e-mail message. The normal mode image that was selected using the Image Size setup item (page 24) is also recorded.

**Control button**

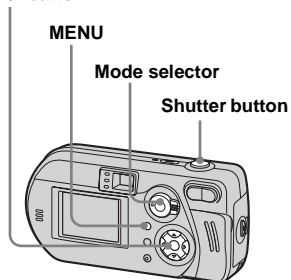

**1** Set the mode selector to .

**2** Press MENU.

The menu appears.



- 3 Select [Mode] (REC Mode) with ◀/▶, then select [E-Mail] with ▲/▼.

- 4 Shoot your image.

You can do the next shooting after “Recording” disappears from the LCD screen.

### To return to normal mode

In Step 3, select [Normal].

- For instructions on how to attach your images to an e-mail message, refer to the Help files of the e-mail software you are using.
- For the number of images that can be recorded, see page 101.

---

## Shooting still images with audio files

### – Voice

#### Mode selector:

You can record still images with audio files.

#### Control button

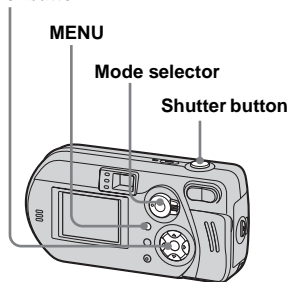

- 1 Set the mode selector to .

- 2 Press MENU.

The menu appears.

- 3 Select [Mode] (REC Mode) with ◀/▶, then select [Voice] with ▲.

- 4 Shoot your image.

If you press and release the shutter button, sound is recorded for five seconds.

If you hold down the shutter button, sound is recorded until you release the shutter button for up to 40 seconds.

### To return to normal mode

In Step 3, select [Normal].

- To view images recorded in Voice mode, carry out the same procedure described in “Viewing movies on the LCD screen” (page 73).
- For the number of images that can be recorded, see page 101.

## Shooting according to scene conditions

### Mode selector:

When shooting night scenes, shooting people at night, shooting landscapes, or shooting a waterfront or a snowscape, use the modes listed below to increase the quality of your images.

### Twilight mode

Under dark lighting conditions, you can shoot a distant night view. However, because the shutter speed is slower under these conditions, we recommend you use a tripod.



- You cannot shoot in Macro mode.
- The flash cannot be used.

### Twilight portrait mode

Use this mode when shooting people in the foreground at night. This mode allows you to shoot images of people in the foreground with distinct outlines without losing the feeling that you are shooting at night. Because the shutter speed is slow, it is recommended that you use a tripod.





- The flash forcibly strobes.

### Landscape mode

Focuses on images far away, so is convenient for shooting landscapes at a distance.





- You cannot shoot in Macro mode.
- The flash is set to  (Forced flash) or  (No flash).

### Snow mode

When the whole of the screen turns white, such as when you are shooting a snowscape, use this mode. This mode prevents the image from losing color and brightens each color.





- The flash is set to  (Forced flash) or  (No flash).

### Beach mode

When shooting at the seaside or the lakeside, the blue of the sea is clearly recorded.



- The flash is set to  (Forced flash) or  (No flash).

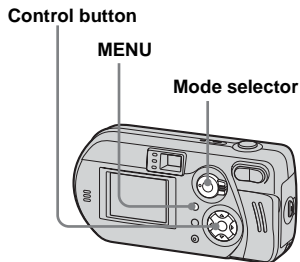

**1** Set the mode selector to

**2** Press MENU.

The menu appears.

**3** Select (Camera) with **◀**, then select the desired mode with **▲/▼**.

### To return to the normal shooting

In Step **3**, select [Auto] or [Program].

- The setting is maintained even when the power is turned off.
- Even when you select Twilight or Twilight portrait mode in Burst 2 mode, the shutter speed setting of the Burst 2 mode has priority. So, the image may not be recorded exactly as you intended.

### NR slow shutter

The NR slow shutter mode removes noise from recorded images, providing clear images. When the shutter speed is slow, the camera automatically works the NR slow shutter mode and “NR” is indicated next to the shutter speed indicator.



Press the shutter button fully down.

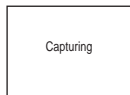

Then the screen turns black.



Finally, when “Processing” disappears, the image has been recorded.

- To eliminate the effects of vibration, use of a tripod is recommended.

## Adding special effects

### – Picture Effect

**Mode selector:**  

You can add special effects to bring out the contrast in your images.

**Solarize**



Like an illustration with clearly delineated bright and dark portions

**B&W**



In black and white

**Sepia**



Colored to look like an old photograph

**Neg.Art**



Made to look like a negative image

### Before operation



When shooting still images, set  (Camera) to any mode other than [Auto] in the menu settings (page 27).

Control button

MENU

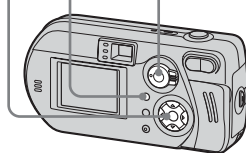



Mode selector



**1** Set the mode selector to  or .

**2** Press MENU.

The menu appears.

**3** Select [PFX] (P.Effect) with  , then select the desired mode with /.

### To cancel Picture Effect

In Step **3**, select [Off].

## Selecting the folder and playing back images

### – Folder

#### Mode selector:

Select the folder that images you want to play back are stored.

#### Control button

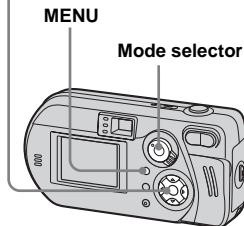

#### 1 Set the mode selector to .

#### 2 Press MENU.

The menu appears.

#### 3 Select [Folder] with , then press .

#### 4 Select the desired folder with .

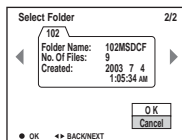

#### 5 Select [OK] with , then press .

### To cancel the selection

In step 5, select [Cancel].

### When multiple folders are created in the “Memory Stick”

When the first or last image in the folder is displayed, the following icons are indicated on the screen.

 : Moves to the previous folder.

 : Moves to the next folder.

 : Moves to both the previous and next folders.

#### On the single screen



#### On the Index (nine-image) screen



#### On the Index (triple-image) screen

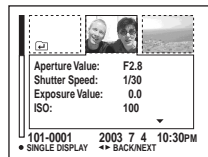

- When no images are stored in the folder, “No file in this folder” appears.
- You can play back images from a last-shot one without selecting the folder.

## Enlarging a portion of a still image

### Mode selector:



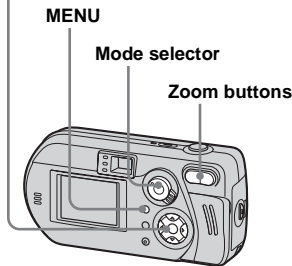

You can enlarge an image up to five times the size of the original image. You can also record the enlarged image as a new file.

#### Control button



## Enlarging an image

– Playback zoom

- 1** Set the mode selector to .
- 2** Display the image you want to enlarge.
- 3** Press the zoom T button to enlarge the image.
- 4** Select a portion of the image to enlarge with .

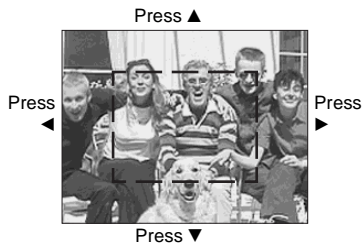

- ▲: To view a portion of the top of the image
- ▼: To view a portion of the bottom of the image
- ◀: To view a portion of the left side of the image
- ▶: To view a portion of the right side of the image

- 5** Adjust the zoom with the zoom W/T buttons.



## To cancel enlarged viewing

Press .

- You cannot use Playback zoom with movies (MPEG movie), or images recorded in Clip Motion/Multi Burst modes.
- If you press the zoom W button when you are viewing images that have not been enlarged, the Index screen will appear (page 37).
- The images displayed in Quick Review (page 28) can be enlarged using the procedures outlined in Steps **3** to **5**.

## Recording an enlarged image – Trimming

- 1** After you have viewed an image using playback zoom, press **MENU**.

The menu appears.

- 2** Select [Trimming] with **▶**, then press **●**.

- 3** Select the image size with **▲/▼**, then press **●**.

The image is recorded, and the screen image returns to the size it was before enlargement.

- The trimmed image is recorded in the recording folder as the newest file, and the original image is retained.
- The trimmed image may suffer some deterioration in image quality.
- You cannot trim to 3:2-sized image.

## Playing back successive images

### – Slide show

**Mode selector:** **▶**

You can play back recorded images in succession, one after another. This is useful for checking your images, or for giving a presentation.

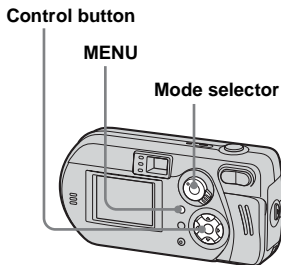

- 1** Set the mode selector to **▶**.

- 2** Press **MENU**.

The menu appears.

- 3** Select [Slide] with **◀/▶**, then press **●**.

Set the following items with **▲/▼/◀/▶**.

Interval settings

3 sec/5 sec/10 sec/30 sec/1 min

Image

Folder: Plays back all the images in the selected folder.

All: Plays back all the images in the "Memory Stick."

Repeat

On: Plays the images back repeatedly.

Off: Plays through the images one time and then stops.

- 4** Select [Start] with **▼/▶**, then press **●**.

The slide show begins.

### To cancel the slide show setting

In Step **3**, select [Cancel].

### To stop slide show playback

Press **●**, select [Exit] with **▶**, then press **●**.

## To skip to the next/previous image during slide show

Press ► (next), or ◀ (previous).

- The interval settings are just guidelines. The actual intervals differ, based on factors like the size of the image.

## Rotating still images

### – Rotate

**Mode selector:** ►

Images shot when holding the camera vertically can be rotated and displayed horizontally.

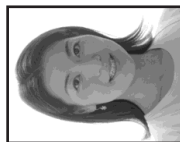

**Control button**

**MENU**

**Mode selector**

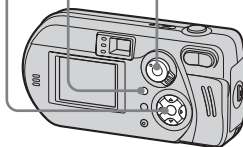

**1** Set the mode selector to ►, and display the image you want to rotate.

**2** Press MENU.

The menu appears.

**3** Select [Rotate] with ◀/►, then press ●.

**4** Select ↶ ↷ with ▲, and rotate the image with ◀/►.

**5** Select [OK] with ▲/▼, then press ●.

### To cancel the rotation

In Step **4** or **5**, select [Cancel].

- Protected images, movies (MPEG movie), or images recorded in Clip Motion/Multi Burst modes cannot be rotated.
- You may not be able to rotate images shot with other cameras.
- Also, when viewing images on a computer, the image rotation information may not be reflected depending on the application software.



## Playing back images shot in Multi Burst mode

### Mode selector:

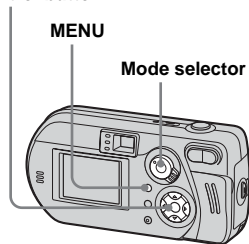

You can play back Multi Burst images continuously or play them back frame by frame. This function is used for checking the images.

#### Control button



- When the images are played back on a computer, the 16 frames you shot will all be displayed at the same time as part of one image.
- When Multi Burst images are played back on a camera without the Multi Burst feature, the 16 frames will all be displayed at the same time, as part of one image, just as they are on a computer.



## Playing back continuously

- 1** Set the mode selector to .
- 2** Select the Multi Burst image with /▶.



The selected Multi Burst image is played back continuously.



### To pause

Press . To resume playback, press  again. The playback starts from the frame displayed on the LCD screen.

## Playing back frame by frame – Jog playback

- 1** Set the mode selector to .
- 2** Select the Multi Burst image with /▶.
- 3** Press  when the desired frame is displayed.

“Step” appears.



- 4** Advance the frame with /▶.

▶: The next frame is displayed. When you press and hold ▶, the frame advances.



◀: The previous frame is displayed. When you press and hold ◀, the frame advances in the reverse direction.

### To return to normal playback

In Step **4**, press . The playback starts from the frame displayed on the LCD screen.

## To delete shot images

When using this mode, you cannot delete only certain frames. When you delete images, all 16 of the frames are deleted at the same time.

- 1 Display the Multi Burst image you want to delete.
- 2 Press  /  (Delete).
- 3 Select [Delete], then press .  
All of the frames are deleted.

## Protecting images

### – Protect





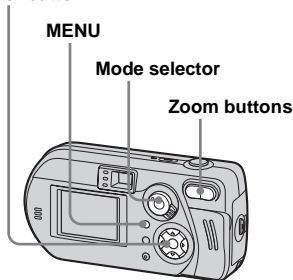

#### Mode selector:

To prevent accidental erasure of an important image, you can protect it.

#### Control button





### On the single screen

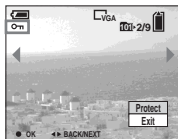

- 1** Set the mode selector to .
- 2** Display the image you want to protect with / .
- 3** Press MENU.  
The menu appears.
- 4** Select [Protect] with / , then press .

The image currently being displayed is now protected, and the  (Protect) mark is indicated on the screen.















- 5** To protect other images, display the image you want to protect with / , then press .

### To cancel the protection

In Step **4** or **5**, press  again. The  mark disappears.

### On the Index (nine-image) screen

- 1** Set the mode selector to , press the zoom W (index) button once to switch to the Index (nine-image) screen.
- 2** Press MENU.  
The menu appears.
- 3** Select [Protect] with / , then press .
- 4** Select [Select] with / , then press .
- 5** Select the image you want to protect with / / / , then press .

The green  (Protect) mark is indicated on the selected image.



- 6** To protect other images, repeat Step **5**.
- 7** Press MENU.

- 8** Select [OK] with **▶**, then press **●**.

The **Ⓚ** mark turns white and the selected image is protected.

### To cancel the protection

In Step **4**, select [Cancel], or in Step **8**, select [Exit].

### To release protection

In Step **5**, select an image for which you want to release protection with **▲/▼/◀/▶** and press **●**. The **Ⓚ** mark turns gray and repeat this operation for all the images for which you want to release protection. Then, press MENU, select [OK], and press **●**.

### To protect all the images in folder

In Step **4**, select [All In Folder], then press **●**. Next, select [On], then press **●**.

### To release protection of all the images in the folder

In Step **4**, select [All In Folder], and press **●**. Then select [Off], and press **●**.

### *On the Index (triple-image) screen*

- 1** Set the mode selector to **▶**, press the zoom **W** (index) button twice to switch to the Index (triple-image) screen.
- 2** Move the image you want to protect to the center with **◀/▶**.

- 3** Press MENU.

The menu appears.

- 4** Select [Protect] with **▲/▼**, then press **●**.

The center image is protected, and the **Ⓚ** (Protect) mark is indicated on that image.

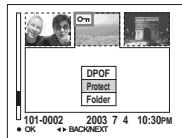

- 5** To protect other images, move the image you want to protect to the center with **◀/▶**, and repeat Step **4**.

### To release protection

In Step **4**, select the image from which you want to release protection, and press **●**. To release protection from all of your images, repeat this process for each of them.

## Changing image size

### – Resize

**Mode selector:** 

You can change the image size of a recorded image, and save it as a new file. You can resize to the following sizes: 3.1M, 2.0M, 1.2M, and VGA. The original image is retained even after resizing.

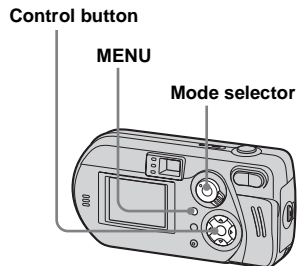

- 1** Set the mode selector to .
- 2** Display the image you want to resize with / .
- 3** Press MENU.  
The menu appears.

**4** Select [Resize] with / , then press .

**5** Select the new size with / , then press .

The resized image is recorded in the recording folder as the newest file.

### To cancel the resizing

In Step **5**, select [Cancel].

- Movies (MPEG movie), or images recorded in Clip Motion/Multi Burst modes cannot be resized.
- When images are resized from a smaller to a larger size, the image quality will deteriorate.
- You cannot resize to 3:2-sized image.
- If you try to resize a 3:2-sized image, black bands will appear at the top and bottom of the image.

## Choosing images to print

### – Print (DPOF) mark

#### Mode selector:

You can designate certain images to be printed.

This mark is convenient when you want to print images at a shop that conforms with the DPOF (Digital Print Order Format) standard.

#### Control button

MENU





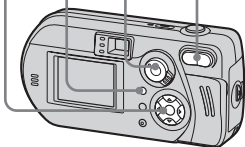

Mode selector

Zoom buttons





- You cannot mark movies (MPEG movie) or images recorded in Clip Motion mode.
- In E-Mail mode, the print (DPOF) mark is marked on the normal size image that was recorded at the same time.
- When you mark images shot in Multi Burst mode, all the images are printed on one sheet divided into 16 panels.

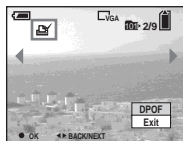

### On the single screen

- 1** Set the mode selector to .
  - 2** Display the image you want to print with / .
  - 3** Press MENU.  
The menu appears.
  - 4** Select [DPOF] with / , then press .
- The  mark is indicated on this image.













- 5** To mark other images, display the image you want to mark with / , then press .

### To delete the mark

In Step **4** or **5**, press  again. The  mark disappears.

### On the Index (nine-image) screen

- 1** Set the mode selector to  and press the zoom W (index) button once to switch to the Index (nine-image) screen.
  - 2** Press MENU.  
The menu appears.
  - 3** Select [DPOF] with , then press .
  - 4** Select [Select] with / , then press .
- You cannot mark using the [All In Folder] option.
- 5** Select the images you want to print with / / , then press .
- The green  mark is indicated on the selected image.



- 6** To mark other images, repeat Step **5** for each of them.

**7** Press **MENU**.

**8** Select **[OK]** with **▶**, then press **●**.

The  mark turns white and the setting is completed.

### To delete the mark

In Step **5**, select the image you want to delete the  mark with **▲/▼/◀/▶**, and press **●**.

### To delete all the marks from the images in the folder

In Step **4**, select **[All In Folder]**, then press **●**. Next, select **[Off]**, then press **●**.

### To cancel the marking

In Step **4**, select **[Cancel]**, or in Step **8**, select **[Exit]**.

*On the Index (triple-image) screen*

**1** Set the mode selector to , press the zoom **W (index)** button twice to switch to the Index (triple-images) screen.

**2** Move the image you want to print to the center with **◀/▶**.

**3** Press **MENU**.

The menu appears.

**4** Select **[DPOF]** with **▲**, then press **●**.

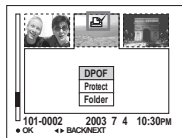

The  mark is indicated on the center image.



**5** To mark other images, move the image you want to print to the center with **◀/▶**, and repeat Step **4**.

### To delete the mark

In Step **4**, press **●** again.

The  mark disappears. To delete the  marks from all of your images, repeat this process for each of them.

## Shooting movies

### Mode selector:

You can shoot movies (MPEG movies).

### Before operation

Set [Moving Image] to [MPEG Movie] in the SET UP settings (pages 45, 106).

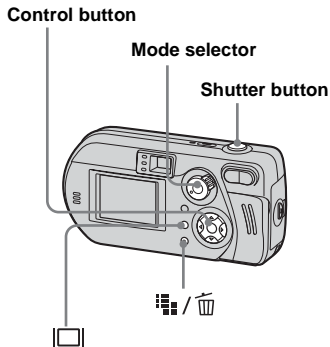

**1** Set the mode selector to .

**2** Press  /  (Image Size).

The Image Size setup item appears.

**3** Select the desired mode with  / .

You can choose from 640 (VGA) or 160 (Mail).

See page 101 for the recording time allowed for each image size.

**4** Press the shutter button fully down.

“REC” appears on the screen and the camera starts recording the image and sound.



• When the capacity of the “Memory Stick” is used up, recording stops.

**5** Press the shutter button fully down again to stop recording.

### Indicators on the screen while you are shooting movies

These indicators are not recorded.

Each time you press , the status of the LCD screen changes as follows: Indicators off → LCD off → Indicators on. See page 114 for a detailed description of the indicated items.

### To shoot close-ups (Macro) (DSC-P72 only)

Set the mode selector to  and follow the procedure on page 30.

### To shoot with a self-timer

Set the mode selector to  and follow the procedure on page 31.

- Be careful not to touch the microphone (pages 8, 10, 12) during shooting.
- The flash cannot be used.
- In MPEG movie, the date and time cannot be inserted.
- You cannot change the zoom scaling while shooting movies.



## Viewing movies on the LCD screen

**Mode selector:** 

You can view movies on the LCD screen of the camera and hear sounds from the speaker of the camera.

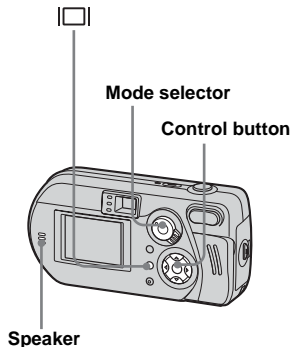

**1** Set the mode selector to .

**2** Select the desired movie with  .

Movies with the image size [160 (Mail)] are displayed a size smaller than still images.

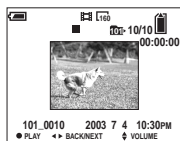

Movies with the image size [640 (VGA)] are displayed on the full screen.

**3** Press .

The movie images and sound are played back.  
 (playback) appears on the LCD screen while a movie is playing back.

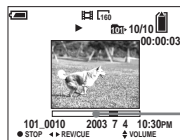

Playback bar



**To stop playback**

Press .

**To adjust the volume**

Press  .

**To fast-forward / rewind**

Press  (next) or  (previous) while playing back a movie.

To return to normal playback, press .

**Indicators on the screen while you are viewing movies**

Each time you press , the status of the LCD screen changes as follows: Indicators off → LCD off → Indicators on. See page 115 for a detailed description of the indicated items.

- The procedure for viewing movies on a TV is the same as that for viewing still images (page 38).
- A movie recorded using other Sony devices is displayed a size smaller than still images.

## Deleting movies

**Mode selector:** 

You can delete unwanted movies.

Control button

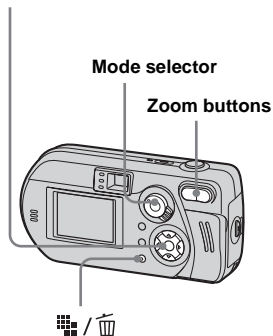

*On the single screen*

**1** Set the mode selector to .



**2** Select the movie you want to delete with / .

**3** Press  /  (Delete).

The movie has not yet been deleted at this point.

**4** Select [Delete] with , then press .

“Memory Stick access” appears on the screen. When this message disappears, the image has been deleted.

**5** To delete other movies, display the movie you want to delete with / , then repeat Step **4**.



**To cancel the deletion**

In Step **4** or **5**, select [Exit].

*On the Index (nine-image) screen*

**1** Set the mode selector to  and press the zoom W (index) button once to display an Index (nine-image) screen.

**2** Press  /  (Delete).

**3** Select [Select] with / , then press .

**4** Select the movies you want to delete with / / , then press .

The  (Delete) mark is indicated on the selected movie.

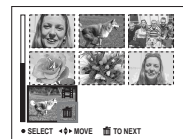

The movie has not yet been deleted at this point.

**5** Repeat Step **4** to delete other movies.

**6** Press  /  (Delete).

- 7** Select [OK] with **▶**, then press **●**.

“Memory Stick access” message appears on the screen. When this message disappears, the movie has been deleted.

### To cancel the deletion

In Step **3** or **7**, select [Exit].

### To delete all the images in the folder

In Step **3**, select [All In Folder], then press **●**. Next, select [OK], then press **●**. To cancel the deletion, select [Cancel] with **◀**, then press **●**.

*On the Index (triple-image) screen*

- 1** Set the mode selector to **▶** and press the zoom **W** (index) button twice to switch to the Index (triple-image) screen.
- 2** Move the movie you want to delete to the center with **◀/▶**.
- 3** Press **⏏** / **🗑** (Delete).

The menu appears.

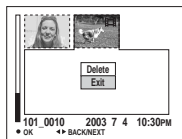

The movie has not yet been deleted at this point.

- 4** Select [Delete] with **▲**, then press **●**.  
“Memory Stick access” message appears on the screen. When this message disappears, the movie has been deleted.

### To cancel the deletion

In Step **4**, select [Exit].

## Editing movies

### Mode selector:

You can cut movies, or delete unnecessary portions of movies. This is the recommended mode to use when the “Memory Stick” capacity is insufficient, or when you attach movies to your e-mail messages.

### The file numbers assigned when movies are cut

The cut movies are assigned new numbers and recorded as the newest files in the recording folder. The original movie is deleted and its file number is skipped.

#### <Example> Cutting the movie numbered 101\_0002

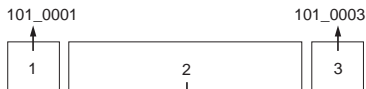

#### 1. Cutting scene A.

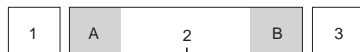

Divide point 101\_0002

#### 2. Cutting scene B.

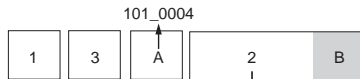

Divide point

#### 3. Deleting scenes A and B if they are unnecessary.

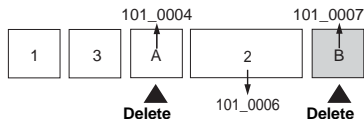

#### 4. Only the desired scenes remain.

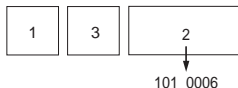

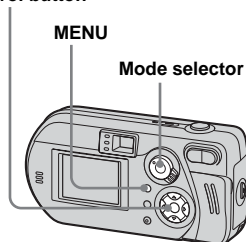

## Cutting movies

### Control button







**1** Set the mode selector to .

**2** Select the movie you want to cut with / .

**3** Press MENU.

The menu appears.

**4** Select [Divide] with , then press . Next, select [OK] with , then press .

The playback of the movie starts.

## 5 Decide on a cutting point.

Press ● at the desired cutting point.

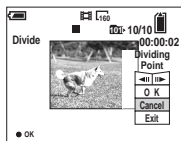

When you want to adjust the cutting point, select [◀||/||▶] (frame forward/rewind) and adjust the cutting point with ◀/▶. If you want to change the cutting point, select [Cancel]. The playback of the movie starts again.

## 6 When you have decided on a cutting point, select [OK] with ▲/▼, and press ●.

## 7 Select [OK] with ▲, then press ●.

The movie is cut.

### To cancel cutting

In Step 5 or 7, select [Exit]. The movie appears on the screen again.

- You cannot cut the following images.
  - Clip Motion
  - Multi Burst
  - Still image
  - Movies not long enough to cut
  - Protected movie
- You cannot restore movies once you cut them.
- The original movie is deleted when you cut it.
- The cut movie is recorded in the selected recording folder as a newest file.

### *Deleting unnecessary portions of movies*

## 1 Cut an unnecessary portion of a movie (page 76).

## 2 Display the portion of the movie you want to delete.

## 3 Press [Delete].

The movie has not yet been deleted at this point.

## 4 Select [Delete] with ▲, then press ●.

The movie currently displayed on the screen is deleted.

---

## *Copying images to your computer*

### *– For Windows users*

#### **Recommended computer environment**

**OS:** Microsoft Windows 98, Windows 98SE, Windows 2000 Professional, Windows Millennium Edition, Windows XP Home Edition, or Windows XP Professional

The above OS must be installed at the factory. Operation is not assured in an environment upgraded to the operating systems described above or in a multi-boot environment.

**CPU:** MMX Pentium 200 MHz or faster

**USB connector:** Provided as standard

**Display:** 800 × 600 dots or more High Color (16-bit color, 65 000 colors) or more

- If you connect two or more USB equipment to a single computer at the same time, some equipment, including your camera, may not operate depending on the type of USB equipment.
- Operations are not guaranteed when using a USB hub.
- Operations are not guaranteed for all the recommended computer environments mentioned above.

#### **USB mode**

There are two modes for a USB connection, [Normal] and [PTP]\* modes. The factory setting is the [Normal] mode.

\* Compatible only with Windows XP. When connected to a computer, only the data in the folder selected by the camera is copied to the computer. To select the folder, follow the procedure on page 61.

#### **Communication with your computer**

When your computer resumes from the suspend or sleep mode, communication between your camera and your computer may not recover at the same time.

#### **When a USB connector is not provided on your computer**

When neither a USB connector nor a “Memory Stick” slot is provided, you can copy images using an additional device. See the Sony Website for details.

<http://www.sony.net/>

#### **Contents of the CD-ROM**

##### **■ USB Driver**

This driver is needed in order to connect the camera to a computer.

When using Windows XP, you need not install the USB driver.

##### **■ Image Transfer**

This application is used to easily transfer images from the camera to a computer.

##### **■ ImageMixer**

This application is used to display and edit images that are stored in a computer.

- This section describes the procedures using Windows Me as an example. The required operations may differ depending on your OS.
- **Close down all applications running on the computer before installing the USB driver and application.**
- When using Windows XP or Windows 2000, log on as Administrators.
- The display settings should be 800 × 600 dots or more and High Color (16-bit color, 65 000 colors) or more. When set to less than 800 × 600 dots or 256 colors or less, the install title screen does not appear.

## Installing the USB driver

When using Windows XP, you need not install the USB driver.

Once the USB driver is installed, you need not install the USB driver.

- 1 Turn on your computer, and insert the supplied CD-ROM into the CD-ROM drive.

**Do not connect your camera to your computer at this time.**

The model selection screen appears. If it does not appear, double-click  (My Computer) → [ImageMixer] in that order.

- 2 Click [Cyber-shot] on the model selection screen.



The installation menu screen appears.

- 3 Click [USB Driver] on the title screen.



The “InstallShield wizard” screen appears.

- 4 Click [Next]. When the “Information” screen appears, click [Next].



The USB driver installation starts. When the installation is completed, the screen informs you of completion.

- 5 Click [Yes, I want to restart my computer now], then click [Finish].

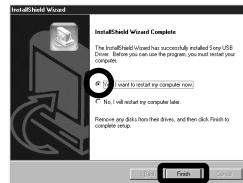

Your computer restarts. Then, you can establish USB connection.

## Installing “Image Transfer”

You can use the “Image Transfer” software to copy images to your computer automatically when you connect the camera to your computer.

- 1 Click [Cyber-shot] on the model selection screen.



The installation menu screen appears.

- 2 Click [Image Transfer] on the installation menu screen. Select the desired language, then click [OK].

The “Welcome to the InstallShield Wizard” screen appears.



- 3 Click [Next]. When “License Agreement” screen appears, click [Yes].

Read the agreement carefully. If you accept the terms of the agreement, proceed with the installation. The “Information” screen appears.



- 4 Click [Next].



- 5 Select the folder to be installed, then click [Next]. Select the program folder, then click [Next].

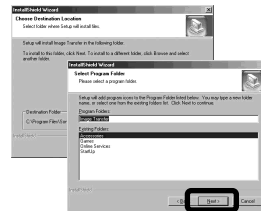

- 6 Confirm if the checkbox is checked on the “Image Transfer Settings” screen, then click [Next].



When the installation is completed, the screen informs you of completion.



## 7 Click [Finish].



The “InstallShield Wizard” screen closes.

If you wish to continue with the installation of “ImageMixer,” click [ImageMixer] on the title screen and then follow the procedure.

- The USB driver is needed in order to use “Image Transfer.” If the necessary driver is not already installed on your computer, a screen that asks if you want to install the driver will appear. Follow the instructions that appear on the screen.

## Installing “ImageMixer”

You can use the “ImageMixer Ver. 1.5 for Sony” software to copy, view and edit images. For details, see the software’s help files.

- 1 Click [ImageMixer] on the installation menu screen. Select the desired language, then click [OK].

The “Welcome to the InstallShield Wizard” screen appears.



- This section describes the English screen.

- 2 Follow instructions on each succeeding screen.

Install “ImageMixer” according to the screen.

- When you use Windows 2000 or Windows XP, install “WinASPI.”

- If DirectX8.0a or a later version is not installed in your computer, the “Information” screen appears. Follow the procedure on the screen.

- 3 Restart your computer according to the screen.

- 4 Remove the CD-ROM.

## Connecting the camera to your computer

- 1** Insert the “Memory Stick” with the images you want to copy into the camera.

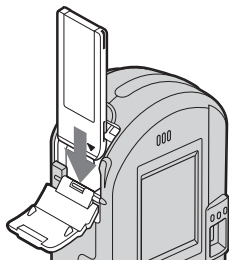

- Be sure to use fully charged nickel-metal hydride batteries or the AC Adaptor (not supplied). When you copy images to your computer using weak batteries, copying may fail or the data may be corrupted if the camera shuts off due to weak batteries.
- For further details on the AC Adaptor, see page 19.
- For further details on the “Memory Stick,” see page 23.

- 2** Turn on your computer and the camera.

- 3** Connect the supplied USB cable to the  (USB) jack of the camera.

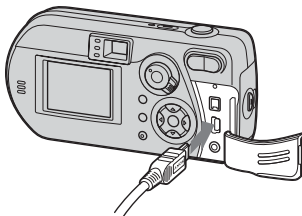

- 4** Connect the USB cable to your computer.

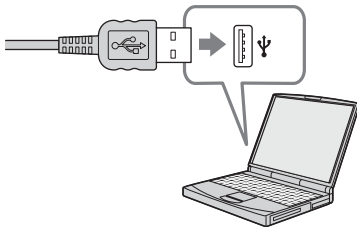

- When using a desktop computer, connect the USB cable to the USB connector on the rear panel.

- When using Windows XP, the AutoPlay wizard automatically appears on the desktop. Proceed to page 85.

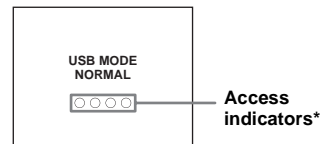



“USB MODE NORMAL” appears on the LCD screen of the camera. When a USB connection is established for the first time, your computer automatically runs the used program to recognize the camera. Wait for a while.

- \* During communication, the access indicators turn red.
- If “USB MODE NORMAL” does not appear, confirm that [USB Connect] is set to [Normal] in the SET UP settings (page 107).

## ❑ Removing the USB cable, removing the “Memory Stick,” or turning off the camera during a USB connection

For Windows 2000, Me, or XP users

- 1 Double-click  on the task tray.
- 2 Click , then click [Stop].
- 3 Confirm the device on the confirmation window, then click [OK].
- 4 Click [OK].  
Step 4 is unnecessary for Windows XP users.
- 5 Disconnect the USB cable, remove the “Memory Stick,” or turn off the camera.

## For Windows 98 or 98SE users

Confirm that the access indicators (page 82) on the LCD screen are turned white and carry out only Step 5 above.

## Copying images using “Image Transfer”

### – Windows 98/98SE/2000/Me

Connect the camera and your computer with the USB cable.

“Image Transfer” launches and the images are automatically copied to the computer. When copying is complete, “ImageMixer” automatically launches and images appear.

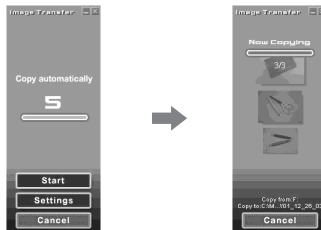

- Normally “Image Transfer” and “Date” folders are created inside the “My Documents” folder, and all of the image files recorded with the camera are copied into these folders.
- You can change the “Image Transfer” settings (page 84).

### – Windows XP

Connect the camera and your computer with the USB cable.

“Image Transfer” starts up automatically and the images are automatically copied to the computer.

Windows XP is set so that the OS AutoPlay Wizard activates.

If you want to cancel the setting, follow the procedure below.

- 1 Click [Start], then click [My Computer].
- 2 Right-click [Sony MemoryStick], then click [Properties].
- 3 Cancel the setting.
  - ① Click [AutoPlay].
  - ② Set [Content type] to [Pictures].
  - ③ Check [Select an action to perform] under [Actions], select [Take no action], then click [Apply].
  - ④ Set [Content type] to [Video files] and proceed step ③. Set [Content type] to [Mixed content] and proceed step ③.
  - ⑤ Click [OK].

The [Properties] screen closes. The OS AutoPlay Wizard does not start up automatically even if the USB connection is made next time.

## Changing “Image Transfer” settings

You can change “Image Transfer” settings. Right-click the “Image Transfer” icon on the task tray, select [Open Settings]. The settings you can set are as follows: [Basic], [Copy], and [Delete].

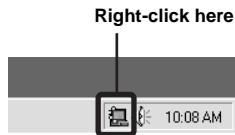

When the “Image Transfer” starts, the below window appears.



When you select [Settings] from the above window, you can only change the [Basic] setting.

## Copying images without using “Image Transfer”

### – Windows 98/98SE/2000/Me

If you do not set to launch “Image Transfer” automatically, you can copy images as following procedure.

#### 1 Double-click [My Computer], then double-click [Removable Disk].

The contents of the “Memory Stick” inserted in your camera appear.

- This section describes an example of copying images to the “My Documents” folder.
- When the “Removable Disk” icon is not shown, see the right column.
- When using Windows XP, see page 85.

#### 2 Double-click [DCIM], then double-click the folder that the image files you want to copy are stored.

The folder opens.

#### 3 Drag and drop the image files into the “My Documents” folder.

The image files are copied to the “My Documents” folder.

- When you try to copy an image to a folder in which an image with the same file name is stored, the overwrite confirmation message appears. When you overwrite the existing image with the new one, the original file is deleted.

## When a removable disk icon is not shown

- 1 Right-click [My Computer], then click [Properties].  
The “System Properties” screen appears.
  - For Windows 2000 users, click the [Hardware] tab on the “System Properties” screen.
- 2 Confirm if other devices are already installed.
  - ① Click [Device Manager].
  - ② Double-click [Other Devices].
  - ③ Confirm if there is a “Sony DSC” with a mark.
- 3 If you find either of the devices above, follow the steps below to delete them.
  - ① Click [Sony DSC]. (In case of Windows 2000, right-click [Sony DSC].)
  - ② Click [Remove]. (In case of Windows 2000, click [Uninstall].) The “Confirm Device Removal” screen appears.
  - ③ Click [OK].  
The device is deleted.

Try the USB driver installation again using the supplied CD-ROM (page 79).

## – Windows XP

### Copying images using the Windows XP AutoPlay wizard

- 1 Make a USB connection (page 82). Click [Copy pictures to a folder on my computer using Microsoft Scanner and Camera Wizard], then click [OK].**

The “Scanner and Camera Wizard” screen appears.

- 2 Click [Next].**

The images stored on the “Memory Stick” are displayed.

- 3 Click the checkbox of images that you do not want to copy to your computer to remove the checkmark, then click [Next].**

The “Picture Name and Destination” screen appears.

- 4 Select a name and destination for your pictures, then click [Next].**

Image copying starts. When the copying is completed, the “Other Options” screen appears.

- 5 Select [Nothing. I’m finished working with these pictures], then click [Next].**

The “Completing the Scanner and Camera Wizard” screen appears.

- 6 Click [Finish].**

The wizard closes.

- To continue copying other images, follow the procedure given under **1** on page 83 to disconnect the USB cable and reconnect it. Then, perform the procedure from step **1** again.

### Viewing the images on your computer

- 1 Double-click [My Documents] on the desktop.**

The “My Documents” folder contents are displayed.

- This section describes the procedure for viewing images in the “My Documents” folder.
- When using Windows XP, double-click [Start] → [My Documents] in that order.
- You can use the “ImageMixer Ver. 1.5 for Sony” software to view and edit images on your computer. For details, see the software’s help files.

- 2 Double-click the desired folder and image file.**

The image is displayed.

## Image file storage destinations and file names

The image files recorded with your camera are grouped as folders in the “Memory Stick.”

### Example: when viewing folders on Windows Me

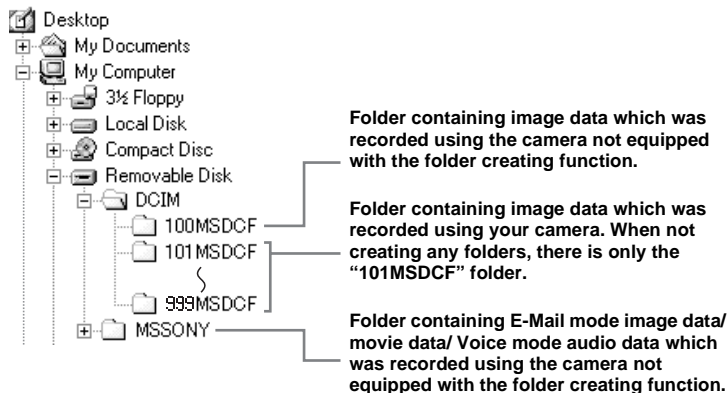

- You cannot record any images to “100MSDCF” or “MSSONY” folders. The images in these folders are available only for viewing.
- For more information about the folder, see pages 46, 61.

Folder	File name	File meaning
101MSDCF to 999MSDCF	DSC0□□□□.JPG	<ul style="list-style-type: none"> <li>• Still image files shot normally               <ul style="list-style-type: none"> <li>– Normal mode (page 26)</li> <li>– Burst 2 mode (page 56)</li> </ul> </li> <li>• Multi Burst mode files (page 55)</li> <li>• Still image files shot in               <ul style="list-style-type: none"> <li>– E-Mail mode (page 56)</li> <li>– Voice mode (page 57)</li> </ul> </li> </ul>
	DSC0□□□□.JPE	• Small-size image files shot in E-Mail mode
	DSC0□□□□.MPG	• Audio files shot in Voice mode
	CLP0□□□□.GIF	• Clip Motion files shot in Normal mode (page 54)
	CLP0□□□□.THM	• Index image files of Clip Motion files shot in Normal mode
	MBL0□□□□.GIF	• Clip Motion files shot in Mobile mode (page 54)
	MBL0□□□□.THM	• Index image files of Clip Motion files shot in Mobile mode
	MOV0□□□□.MPG	• Movie files shot in MPEG Movie mode (page 72)

- □□□□ stands for any number within the range from 0001 to 9999.
- The numerical portions of the following files are the same.
  - A small-size image file shot in E-Mail mode and its corresponding image file
  - An audio file shot in Voice mode and its corresponding image file
  - An image file shot with Clip Motion and its corresponding index image file

## Copying images to your computer

– For Macintosh users

### Recommended computer environment

**OS:** Mac OS 8.5.1, 8.6, 9.0, 9.1, 9.2, or Mac OS X (v10.0/v10.1/v10.2)

The above OS must be installed at the factory. For the following models, update your OS to Mac OS 9.0 or 9.1.

- iMac with Mac OS 8.6 installed at the factory, and a slot loading type CD-ROM drive
- iBook or Power Mac G4 with the Mac OS 8.6 installed at the factory

**USB connector:** Provided as standard

**Display:** 800 × 600 dots or more  
32 000-color mode or more

- If you connect two or more USB equipment to a single computer at the same time, some equipment, including your camera, may not operate depending on the type of USB equipment.
- Operations are not guaranteed when using a USB hub.
- Operations are not guaranteed for all the recommended computer environments mentioned above.

### USB mode

There are two modes for a USB connection, [Normal] and [PTP]\* modes. The factory setting is the [Normal] mode.

\* Compatible only with Mac OS X. When connected to a computer, only the data in the folder selected by the camera is copied to the computer.

### Communication with your computer

When your computer resumes from the suspend or sleep mode, communication between your camera and your computer may not recover at the same time.

### When a USB connector is not provided on your computer

When neither a USB connector nor a “Memory Stick” slot is provided, you can copy images using an additional device. See the Sony Website for details.

<http://www.sony.net/>

### Steps your OS requires

Follow the steps below, according to your OS.

OS	Steps
Mac OS 8.5.1/8.6/9.0	Steps <b>1</b> to <b>4</b>
Mac OS 9.1/9.2/Mac OS X (v 10.0/v 10.1/v10.2)	Steps <b>2</b> to <b>4</b>

## 1 Installing the USB driver

- 1 Turn on your computer, and set the supplied CD-ROM into the CD-ROM drive.  
The model selection screen appears.
- 2 Click [Cyber-shot] on the model selection screen.  
The installation menu appears.
- 3 Click  [USB Driver].  
The “USB Driver” screen appears.
- 4 Double-click the icon of the hard disk containing the OS to open the screen.
- 5 Drag and drop the following two files from the screen opened in step 3 into the System Folder icon in the screen opened in step 4.
  - Sony USB Driver
  - Sony USB Shim
- 6 When the message for confirmation is shown, click “OK.”
- 7 Restart the computer and remove the CD-ROM from the CD-ROM drive.

## 2 Connecting your camera to your computer

For details, see page 82.



### Removing the USB cable, removing the “Memory Stick,” or turning off the camera during a USB connection

Drag and drop the drive icon or the icon of the “Memory Stick” to the “Trash” icon, then remove the USB cable, remove the “Memory Stick,” or turn off the camera

- If you are using Mac OS X v10.0, remove the USB cable etc., after you have turned your computer off.

### 3 Copying images

- 1 Double-click the newly recognized icon on the desktop.  
The contents of the “Memory Stick” inserted in your camera appear.
- 2 Double-click “DCIM.”
- 3 Double-click the folder that the images you want to copy are stored.
- 4 Drag and drop the image files to the hard disk icon.  
The image files are copied to your hard disk.  
For details on the storage location of the images and file names, see page 86.

### 4 Viewing the images on your computer

- 1 Double-click the hard disk icon.
- 2 Double-click the desired image file in the folder containing the copied files.  
The image file opens.

- **Close down all applications running on the computer before installing the USB driver and application.**
- You can use the “ImageMixer Ver. 1.5 for Sony” software to copy images to your computer and to view images on your computer. For details on installing, see operating instructions supplied with the CD-ROM. For details on operation, see the software’s help files.
- “ImageMixer Ver. 1.5 for Sony” cannot be used with Mac OS X.
- “Image Transfer” cannot be used with Macintosh.

### For Mac OS X users

When you click an E-MAIL mode image file, “There is no application available to open the document “DSC0□□□□.JPE”.” may be shown. In this case, carry out the following setup. The screen may differ depending on your OS version.

- 1 Click [Choose Application...] on the screen “There is no application available to open the document “DSC0□□□□.JPE”.”
- 2 Change [Recommended Applications] to [All Applications].
- 3 Select [QuickTime Player] from the application list, then click [Open].

## Creating a Video CD

You can create a Video CD using your computer. The created Video CD can be played back on a Video CD-compatible DVD player. When playing back on a computer, use application software used to play back a Video CD.

### 1 Start “ImageMixer.”

### 2 Click .

The video CD creating mode turns on.

### 3 Drag & drop the desired file or album to the menu screen.

The selected image is added to the menu screen.



### 4 Click .



You can preview the image.

### 5 Click .

The disc creation dialogue appears.

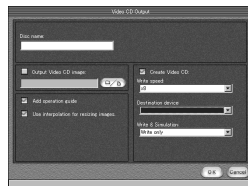

### 6 Insert a blank CD-R into the CD-R drive and click the [OK] button.

The disc creation process starts.

- You cannot use CD-RW discs.
- A CD-R drive is required to create a Video CD.

### For the Macintosh edition

- “Toast” by Roxio (not supplied) is required to create a Video CD.
- The playback time of a movie file on the preview screen may be shorter.

## Troubleshooting

If you have trouble with your camera, try the following solutions.

- 1 Check the items on pages 91 to 97. **If the screen shows “C:□□:□□,” the self-diagnosis function is working. Please see page 100.**

- 2 Press the RESET button located inside the jack cover, then turn on the camera again. (This will clear the date and time settings, etc.)

- 3 Consult your Sony dealer or local authorized Sony service facility.

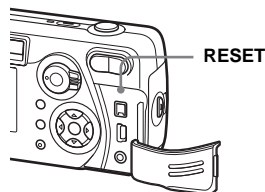





















### Battery and power

Symptom	Cause	Solution
<b>The battery remaining indicator is incorrect. Or the sufficient battery remaining indicator is displayed but the power soon runs out.</b>	<ul style="list-style-type: none"><li>• You have used the camera in an extremely cold location.</li><li>• The batteries are discharged.</li><li>• The battery contacts or the terminals on the battery cover are dirty.</li><li>• The nickel-metal hydride batteries are exhibiting the “memory effect” (page 15).</li><li>• A mismatch has occurred in the remaining battery time information.</li><li>• The batteries are dead (page 110).</li></ul>	<p>—</p> <ul style="list-style-type: none"><li>→ Install charged batteries (page 14).</li><li>→ Wipe any dirt off from them with a dry cloth (page 16).</li><li>→ To restore the batteries to their original condition, use them until they are drained before recharging them.</li><li>→ Fully charge the batteries (page 14).</li><li>→ Replace the batteries with new ones.</li></ul>
<b>The battery runs down too quickly.</b>	<ul style="list-style-type: none"><li>• You are recording/playing back images in an extremely cold location.</li><li>• The batteries are not charged enough.</li><li>• The batteries are dead (page 110).</li></ul>	<p>—</p> <ul style="list-style-type: none"><li>→ Fully charge the batteries (page 14).</li><li>→ Replace the batteries with new ones.</li></ul>
<b>The power cannot be turned on.</b>	<ul style="list-style-type: none"><li>• The batteries are not installed properly.</li><li>• The AC Adaptor (not supplied) is disconnected.</li><li>• The batteries are discharged.</li><li>• The batteries are dead (page 110).</li></ul>	<ul style="list-style-type: none"><li>→ Properly install the batteries (page 16).</li><li>→ Connect it securely to your camera (page 19).</li><li>→ Install charged batteries (page 14).</li><li>→ Replace the batteries with new ones.</li></ul>

Symptom	Cause	Solution
<b>The power turns off suddenly.</b>	<ul style="list-style-type: none"> <li>If you do not operate the camera for about 90 seconds while the power is on, the camera turns off automatically to prevent wearing down the battery (when [Power Save] is [Off], after three minutes.) (page 17).</li> <li>The batteries are discharged.</li> </ul>	<p>→ Turn on the camera again (page 20).</p> <p>→ Install charged batteries (page 14).</p>

## Shooting still images / movies



Symptom	Cause	Solution
<b>The LCD screen is not turned on even when the power is turned on.</b>	<ul style="list-style-type: none"> <li>The power was turned off with the LCD screen turned off the last time you used the camera.</li> </ul>	→ Turn on the LCD screen (page 34).
<b>The subject is not visible on the LCD screen.</b>	<ul style="list-style-type: none"> <li>The mode selector is not set to  or .</li> </ul>	→ Set the mode selector to  or  (pages 26, 72).
<b>The image is out of focus.</b>	<ul style="list-style-type: none"> <li>The subject is too close.</li> <li>While shooting still images,  (Camera) is set to  or .</li> <li>You set the focus preset distance.</li> </ul>	<p>→ Set the macro recording mode (DSC-P72 only). Make sure to place the lens farther away from the subject than the shortest shooting distance when shooting (page 30).</p> <p>→ Cancel the mode (page 58).</p> <p>→ Set to the auto focus mode (page 49).</p>
<b>Unable to zoom (DSC-P52/P72 only).</b>	<ul style="list-style-type: none"> <li>You cannot zoom while shooting a movie (MPEG movie).</li> </ul>	—
<b>Smart zoom does not function.</b>	<ul style="list-style-type: none"> <li>You cannot use smart zoom while shooting a movie (MPEG movie).</li> <li>The LCD screen is turned off.</li> <li>The image size is set to [3.1M] or [2.8M (3:2)].</li> <li>[Smart Zoom] is set to [Off] in the SET UP settings (DSC-P52/P72 only).</li> </ul>	<p>—</p> <p>→ Turn on the LCD screen (page 34).</p> <p>→ Set image size to other settings except [3.1M] and [2.8M (3:2)] (page 29).</p> <p>→ Set [Smart Zoom] to [On] (page 106).</p>
<b>The image is too dark.</b>	<ul style="list-style-type: none"> <li>You are shooting a subject with a light source behind the subject.</li> <li>The brightness of the LCD screen is too low.</li> </ul>	<p>→ Adjust the exposure (page 50).</p> <p>→ Adjust the brightness of the LCD screen (page 107).</p>

Symptom	Cause	Solution
The image is too bright.	<ul style="list-style-type: none"> <li>You are shooting a spot lighted subject in a dark location such as on a stage.</li> <li>The brightness of the LCD screen is too high.</li> </ul>	<ul style="list-style-type: none"> <li>→ Adjust the exposure (page 50).</li> <li>→ Adjust the brightness of the LCD screen (page 107).</li> </ul>
The image is monochrome (black and white).	<ul style="list-style-type: none"> <li>[PFX] (P. Effect) is set to [B&amp;W].</li> </ul>	<ul style="list-style-type: none"> <li>→ Cancel the mode (page 60).</li> </ul>
Vertical streaks appear when you are shooting a very bright subject.	<ul style="list-style-type: none"> <li>The smear phenomenon is occurring.</li> </ul>	<ul style="list-style-type: none"> <li>→ This is not a malfunction.</li> </ul>
When looking at the LCD screen in a dark place, some noise may show up on the screen.	<ul style="list-style-type: none"> <li>The camera temporarily brightens the LCD screen to allow you to check the image being displayed while you are using the camera in a dark place.</li> </ul>	<ul style="list-style-type: none"> <li>→ This will have no effect on the image you shoot.</li> </ul>
You cannot shoot images.	<ul style="list-style-type: none"> <li>No “Memory Stick” is inserted.</li> <li>The capacity of the “Memory Stick” is insufficient.</li> <li>The write-protect switch on the “Memory Stick” is set to the LOCK position.</li> <li>You cannot shoot while the flash is charging.</li> <li>The mode selector is not set to  when you want to shoot a still image.</li> <li>The mode selector is not set to  when you want to shoot a movie.</li> </ul>	<ul style="list-style-type: none"> <li>→ Insert a “Memory Stick” (page 23).</li> <li>→ Delete the images saved in the “Memory Stick,” or format it.</li> <li>→ Change the “Memory Stick.”</li> <li>→ Set it to the recording position (page 109).</li> <li>—</li> <li>→ Set the mode selector to  (page 26).</li> <li>→ Set the mode selector to  (page 72).</li> </ul>
The macro mode does not function (DSC-P72 only).	<ul style="list-style-type: none"> <li>When shooting still images,  (Camera) is set to  or .</li> </ul>	<ul style="list-style-type: none"> <li>→ Cancel the mode (page 58).</li> </ul>
Cannot shoot images with the flash.	<ul style="list-style-type: none"> <li>The mode selector is set to  or SET UP.</li> <li>The flash is set to  (No flash).</li> <li>When shooting still images,  (Camera) is set to .</li> <li>[Moving Image] is not set to [Clip Motion] in the SET UP settings.</li> </ul>	<ul style="list-style-type: none"> <li>→ Set it to a setting other than , or SET UP (page 32).</li> <li>→ Set the flash to “Auto” (No indicator),  (Forced flash), or  (Slow synchro) (page 32).</li> <li>→ Cancel the mode (page 58).</li> <li>→ Set it to [Clip Motion] (page 106).</li> </ul>
The eyes of the subject come out red.	—	<ul style="list-style-type: none"> <li>→ Set [Red Eye Reduction] to [On] (page 33).</li> </ul>



Symptom	Cause	Solution
The date and time are recorded incorrectly.	<ul style="list-style-type: none"> <li>The date and time are not set correctly.</li> </ul>	→ Set the correct date and time (page 21).

## Viewing images

Symptom	Cause	Solution
The image cannot be played back.	<ul style="list-style-type: none"> <li>The mode selector is not set to .</li> <li>You cannot play back the image on the camera, if it is modified on a computer or its folder/file name is changed.</li> <li>The camera is in USB mode.</li> </ul>	→ Set the mode selector to  (page 36). — → Cancel USB communication (page 83).
The image is coarse right after being played back.	—	→ This is not a malfunction.
The images cannot be played back on a TV.	<ul style="list-style-type: none"> <li>The [Video Out] setting for the camera in SET UP is incorrect.</li> <li>The connection is not correct.</li> </ul>	→ Set [Video Out] to [NTSC] or [PAL] (page 107). → Check the connection (page 38).
The images cannot be played back on a computer.	—	→ See page 95.
Unknown beeps are heard from the camera while viewing a movie.	<ul style="list-style-type: none"> <li>These beeps are heard when the auto focus is working.</li> </ul>	→ This is not a malfunction. Shoot in focus preset mode (page 49).

## Deleting/editing an image

Symptom	Cause	Solution
Your camera cannot delete an image.	<ul style="list-style-type: none"> <li>The image is protected.</li> <li>The write-protect switch on the “Memory Stick” is set to the LOCK position.</li> </ul>	→ Cancel the protection (page 67). → Set it to the recording position (page 109).
You have deleted the image by mistake.	<ul style="list-style-type: none"> <li>Once you have deleted an image, you cannot restore it.</li> </ul>	→ Protecting the image can prevent accidental erasure (page 67). → The write-protect switch on the “Memory Stick” will prevent you from deleting images by mistake (page 109).

Symptom	Cause	Solution
<b>The resizing function does not work.</b>	<ul style="list-style-type: none"> <li>• Movie (MPEG movie)/Clip Motion/Multi Burst files cannot be resized.</li> </ul>	—
<b>You cannot attach a print (DPOF) mark.</b>	<ul style="list-style-type: none"> <li>• Print (DPOF) marks cannot be attached to movie (MPEG movie)/Clip Motion files.</li> </ul>	—
<b>You cannot cut a movie.</b>	<ul style="list-style-type: none"> <li>• The movie is not long enough to cut.</li> <li>• Protected movie (MPEG movie), Clip Motion, Multi Burst files and still images cannot be cut.</li> </ul>	— —

## Computers

Symptom	Cause	Solution
<b>You do not know whether or not your OS can be used with the camera.</b>	—	→ Check “Recommended computer environment” (pages 78, 88).
<b>You cannot install the USB driver.</b>	—	→ In Windows 2000, log on as Administrator (authorized Administrators).
<b>Your computer does not recognize your camera.</b>	<ul style="list-style-type: none"> <li>• The camera is turned off.</li> <li>• The battery level is too low.</li> <li>• You are not using the supplied USB cable.</li> <li>• The USB cable is not connected securely.</li> </ul> <ul style="list-style-type: none"> <li>• [USB Connect] is set to [PTP] in the SET UP settings.</li> <li>• The USB connectors on your computer are connected to other equipment besides the keyboard, the mouse.</li> <li>• The camera is not directly connected to your computer.</li> <li>• The USB driver is not installed.</li> <li>• Your computer does not properly recognize the device because you connected the camera and your computer with the USB cable before you installed the “USB Driver” from the supplied CD-ROM.</li> </ul>	<ul style="list-style-type: none"> <li>→ Turn on the camera (page 20).</li> <li>→ Use the AC Adaptor (not supplied) (page 19).</li> <li>→ Use the supplied USB cable (page 82).</li> <li>→ Disconnect the USB cable, and securely connect it again. Make sure that “USB MODE” is displayed on the LCD screen (page 82).</li> <li>→ Set it to [Normal] (page 107).</li> </ul> <ul style="list-style-type: none"> <li>→ Disconnect the USB cables except for those connected to the keyboard and the mouse.</li> </ul> <ul style="list-style-type: none"> <li>→ Directly connect the camera and your computer without using a USB hub.</li> <li>→ Install the USB driver (page 79).</li> <li>→ Delete the erroneously recognized device from your computer, then install the USB driver (pages 79, 84).</li> </ul>

Symptom	Cause	Solution
<b>You cannot copy images.</b>	<ul style="list-style-type: none"> <li>• The camera is not correctly connected to your computer.</li> <li>• The copy procedure differs depending on your OS.</li> </ul>	<ul style="list-style-type: none"> <li>→ Connect the camera and your computer correctly (page 82).</li> <li>→ Follow the copy procedure for your OS (pages 83, 84, 88).</li> <li>→ If you are using the “ImageMixer Ver. 1.5 for Sony” software, click on HELP.</li> <li>→ If you are using the “Image Transfer” software, see page 83.</li> </ul>
<b>After making a USB connection, “Image Transfer” does not automatically start.</b>	—	<ul style="list-style-type: none"> <li>→ Select [Launch Image Transfer automatically when the camera, etc., is connected.] at [Basic] setting (page 84).</li> <li>→ Make a USB connection when the computer is turned on (page 82).</li> </ul>
<b>The image cannot be played back on a computer.</b>	—	<ul style="list-style-type: none"> <li>→ If you are using the “ImageMixer Ver. 1.5 for Sony” software, click on HELP.</li> <li>→ Consult the computer or software manufacturer.</li> </ul>
<b>The image and sound are affected by noise when you play back a movie on a computer.</b>	<ul style="list-style-type: none"> <li>• You are playing back the movie directly from the “Memory Stick.”</li> </ul>	<ul style="list-style-type: none"> <li>→ Copy the movie to the hard disk of the computer and then play the movie file back from the hard disk (page 88).</li> </ul>
<b>You cannot print an image.</b>	—	<ul style="list-style-type: none"> <li>→ Check the printer settings.</li> <li>→ If you are using the “ImageMixer Ver. 1.5 for Sony” software, click on HELP.</li> </ul>
<b>The error message appears when loading the supplied CD-ROM.</b>	—	<ul style="list-style-type: none"> <li>→ Set the display mode of your computer as follows: For Windows, 800 × 600 dots or more, high color (16-bit color, 65 000 colors) or more. For Macintosh, 800 × 600 dots or more, 32 000 colors or more.</li> </ul>

### “Memory Stick”

Symptom	Cause	Solution
<b>You cannot insert a “Memory Stick.”</b>	<ul style="list-style-type: none"> <li>• You are inserting it backwards.</li> </ul>	<ul style="list-style-type: none"> <li>→ Insert it from the right side (page 23).</li> </ul>
<b>You cannot record on a “Memory Stick.”</b>	<ul style="list-style-type: none"> <li>• The write-protect switch on the “Memory Stick” is set to the LOCK position.</li> <li>• The “Memory Stick” is full.</li> </ul>	<ul style="list-style-type: none"> <li>→ Set it to the recording position (page 109).</li> <li>→ Delete unnecessary images (pages 40, 74).</li> </ul>



Symptom	Cause	Solution
<b>You cannot format a “Memory Stick.”</b>	<ul style="list-style-type: none"> <li>The write-protect switch on the “Memory Stick” is set to the LOCK position.</li> </ul>	→ Set it to the recording position (page 109).
<b>You have formatted a “Memory Stick” by mistake.</b>	<ul style="list-style-type: none"> <li>All the data on the “Memory Stick” are erased by formatting.</li> </ul>	→ We recommend that you set the “Memory Stick” write-protect switch to the LOCK position to protect accidental erasure (page 109).

## Others

Symptom	Cause	Solution
<b>The camera does not work, no operations can be performed.</b>	<ul style="list-style-type: none"> <li>The battery level is low or zero (The  indicator appears.).</li> <li>The AC Adaptor (not supplied) is not connected securely.</li> </ul>	<p>→ Charge the batteries (page 14).</p> <p>→ Connect it securely to the DC IN jack of the camera and to a wall outlet (wall socket) (page 19).</p>
<b>The power is on, but the camera does not work.</b>	<ul style="list-style-type: none"> <li>The internal system is not working properly.</li> </ul>	→ Disconnect, and then, after one minute, reconnect all power sources and turn on the camera. If this does not work, press the RESET button located inside the jack cover with a pointed object, then turn the power on again. (This will clear the date and time settings, etc.)
<b>You cannot identify the indicator on the LCD screen.</b>	—	→ Check the indicator (pages 113 to 115).
<b>The lens gets fogged.</b>	<ul style="list-style-type: none"> <li>Condensation is occurring.</li> </ul>	→ Turn off the camera, leave the camera for about an hour and then try to use it again (page 108).
<b>The camera gets hot if you use it for a long time.</b>	—	→ This is not a malfunction.
<b>The lens does not move when you turn off the camera. (DSC-P72 only)</b>	<ul style="list-style-type: none"> <li>The batteries are discharged.</li> </ul>	→ Replace them with charged batteries or use the AC Adaptor (not supplied) (pages 14, 16, 19).

## Warnings and messages

The following messages appear on the LCD screen.

Message	Meaning/ Corrective Action
<b>No Memory Stick</b>	<ul style="list-style-type: none"><li>• Insert a “Memory Stick” (page 23).</li></ul>
<b>System error</b>	<ul style="list-style-type: none"><li>• Turn the power off and on again (page 20).</li></ul>
<b>Memory Stick error</b>	<ul style="list-style-type: none"><li>• The inserted “Memory Stick” cannot be used with your camera (page 109).</li><li>• Insert the “Memory Stick” correctly (page 23).</li><li>• The “Memory Stick” is damaged, or the terminal section of the “Memory Stick” is dirty.</li></ul>
<b>Memory Stick type error</b>	<ul style="list-style-type: none"><li>• The inserted “Memory Stick” cannot be used with your camera (page 109).</li></ul>
<b>Format error</b>	<ul style="list-style-type: none"><li>• The “Memory Stick” format failed. Format the “Memory Stick” again (page 44).</li></ul>
<b>Memory Stick locked</b>	<ul style="list-style-type: none"><li>• The write-protect switch on the “Memory Stick” is set to the LOCK position. Set it to the recording position (page 109).</li></ul>
<b>No memory space</b>	<ul style="list-style-type: none"><li>• The capacity of the “Memory Stick” is insufficient. You cannot record images. Delete unnecessary images (pages 40, 74).</li></ul>
<b>No file in this folder</b>	<ul style="list-style-type: none"><li>• No images have been recorded in this folder.</li></ul>
<b>Folder error</b>	<ul style="list-style-type: none"><li>• A folder with the same first three digits number already exists in the “Memory Stick.” (For example: 123MSDCF and 123ABCDE) Select other folders, or create a new folder.</li></ul>
<b>Cannot create more folders</b>	<ul style="list-style-type: none"><li>• The folder whose first three digits of the name is “999” exists in the “Memory Stick.” You cannot create any folders.</li></ul>
<b>Cannot record</b>	<ul style="list-style-type: none"><li>• You attempt to select the folder that is available only for viewing with your camera. Select other folders (page 47).</li></ul>
<b>File error</b>	<ul style="list-style-type: none"><li>• An error occurred while playing back the image.</li></ul>
<b>File protect</b>	<ul style="list-style-type: none"><li>• The image is protected against erasure. Release the protection (page 67).</li></ul>
<b>Image size over</b>	<ul style="list-style-type: none"><li>• You are playing back an image of a size that cannot be played back on your camera.</li></ul>
<b>Can not divide</b>	<ul style="list-style-type: none"><li>• The movie is not long enough to be divided.</li><li>• The file is not a movie (MPEG movie).</li></ul>
<b>Invalid operation</b>	<ul style="list-style-type: none"><li>• You are playing back a file that was created on equipment other than your camera.</li></ul>
	<ul style="list-style-type: none"><li>• The battery level is low or zero. Charge the battery (page 14). Depending on the conditions of use or the type of battery, the indicator may flash even though there are still 5 to 10 minutes of remaining battery time left.</li></ul>

Message	Meaning/ Corrective Action
	<ul style="list-style-type: none"><li>• Camera shake may occur due to insufficient light. Use the flash, mount the camera on a tripod, or otherwise secure the camera in place.</li></ul>
<b>Turn the power off and on again</b>	<ul style="list-style-type: none"><li>• A problem with the lens caused an error.</li></ul>

## Self-diagnosis display

### – If a code starting with an alphabet letter appears

Your camera has a self-diagnosis display. This function displays the condition of the camera on the LCD screen using a combination of a letter and four numerical digits. If this occurs, check the following code chart and take the corresponding countermeasure. The last two digits (indicated by □□) will differ depending on the state of the camera.

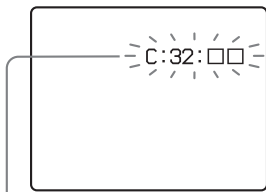

Self-diagnosis display

Code	Cause	Countermeasure
<b>C:32:</b> □□	There is trouble with your camera's hardware.	Turn the power off and on again (page 20).
<b>C:13:</b> □□	The camera cannot read or write data on the "Memory Stick."	Re-insert the "Memory Stick" several times.
	An unformatted "Memory Stick" is inserted.	Format the "Memory Stick" (page 44).
	The inserted "Memory Stick" cannot be used with your camera, or the data is damaged.	Insert a new "Memory Stick" (page 23).
<b>E:61:</b> □□ <b>E:91:</b> □□ <b>E:92:</b> □□	A camera malfunction that you cannot reverse has occurred.	Press the RESET button (page 91) located inside the jack cover, then turn on the camera again.

If your camera is not still functioning well after trying the countermeasure a couple of times, the camera may be repaired. Contact your Sony dealer or local authorized Sony service facility and inform them of the 5-digit code.

Example: E:61:10

## The number of images that can be saved/shooting time

The number of images that can be saved and the shooting time are different, depending on the capacity of the “Memory Stick,” the image size, and the image quality. Refer to the following charts when you choose a “Memory Stick.”

- The number of images is listed in Fine (Standard) order.
- The values for the number of images that can be saved and the shooting time may vary, depending on the shooting conditions.
- For normal shooting times and numbers of images that can be saved, see page 25.
- When the remaining number of images recordable is more than 9999, “>9999” is indicated.

### E-mail

(Units: images)

	16MB	32MB	64MB	128MB	MSX-256	MSX-512	MSX-1G
3.1M	10 (18)	20 (36)	40 (73)	81 (146)	145 (255)	296 (518)	604 (1058)
2.8M (3:2)	10 (18)	20 (36)	40 (73)	81 (146)	145 (255)	296 (518)	604 (1058)
2.0M	16 (29)	32 (59)	65 (119)	131 (239)	230 (420)	468 (854)	956 (1743)
1.2M	24 (44)	49 (89)	98 (179)	197 (359)	340 (595)	691 (1210)	1411 (2470)
VGA	88 (194)	178 (392)	358 (788)	718 (1580)	1190 (2381)	2420 (4841)	4940 (9881)

### Voice

(Units: images)

	16MB	32MB	64MB	128MB	MSX-256	MSX-512	MSX-1G
3.1M	9 (17)	19 (34)	39 (69)	79 (138)	142 (246)	290 (500)	592 (1022)
2.8M (3:2)	9 (17)	19 (34)	39 (69)	79 (138)	142 (246)	290 (500)	592 (1022)
2.0M	15 (26)	31 (54)	62 (109)	125 (219)	223 (396)	453 (806)	926 (1646)
1.2M	22 (38)	45 (78)	91 (157)	183 (316)	324 (549)	660 (1117)	1347 (2280)
VGA	69 (121)	140 (245)	281 (492)	564 (987)	1020 (1785)	2074 (3630)	4234 (7410)

### Clip Motion

(Units: images)

	16MB	32MB	64MB	128MB	MSX-256	MSX-512	MSX-1G
Normal	88	178	358	718	1190	2420	4940
Mobile	486	982	1971	3951	3571	7261	14821

Normal: When 10 frames are shot  
 Mobile: When two frames are shot

### MPEG movie

(Units: seconds)

	16MB	32MB	64MB	128MB	MSX-256	MSX-512	MSX-1G
640 (VGA)	42	87	176	354	641	1304	2663
160 (Mail)	673	1363	2740	5494	9935	20203	41239

### Multi Burst

















(Units: images)

	16MB	32MB	64MB	128MB	MSX-256	MSX-512	MSX-1G
1.2M	24 (46)	50 (93)	101(187)	202 (376)	357 (649)	726 (1320)	1482 (2694)

## Menu items

Menu items that can be changed differ depending on the position of the mode selector. The LCD screen shows only the items you can operate based on the current position of the mode selector. Factory settings are indicated with ■.







### When the mode selector is set to

Item	Setting	Description
 (Camera)	 /  /  /  /  /  / Program/ ■ Auto	Selects the camera mode (pages 27, 58).
 (EV)*	+2.0EV / +1.7EV / +1.3EV / +1.0EV / +0.7EV / +0.3EV / ■0EV / -0.3EV / -0.7EV / -1.0EV / -1.3EV / -1.7EV / -2.0EV	Adjusts the exposure (page 50).
 (Focus)*	∞ / 7.0m / 3.0m / 1.0m / 0.5m / Center AF / ■ Multi AF	Chooses the auto focus method (page 48), or sets the focus preset distance (page 49).
 (Metering Mode)* (DSC-P72 only)	Spot / ■ Multi	Selects the metering mode to suit the shooting conditions and purpose. (page 51).
WB (White Bal)*	 /  /  /  / ■Auto	Sets the white balance (page 52).
ISO*	400 / 200 / 100 / ■Auto	Selects the ISO sensitivity. When shooting under dark conditions or shooting a fast-moving subject, use a high-number setting. When recording high-quality images, use a low-number setting. (When the  (Camera) is not set to [Auto] or [Program], this setting cannot be carried out.)
 (P.Quality)*	■ Fine / Standard	Records images with fine image quality mode. / Records images in the standard image quality mode (page 46).











Item	Setting	Description
<b>Mode (REC Mode)</b>	Voice E-Mail  Burst 2 ■Normal	<ul style="list-style-type: none"> <li>– Records an audio file (with a still image) in addition to the JPEG file (page 57).</li> <li>– Records a small-size (320×240) JPEG file in addition to the selected image size (page 56).</li> <li>– Records two images continuously (page 56).</li> <li>– Records an image using the normal recording mode.</li> </ul>
<b>± (Flash Level)*</b>	High / ■Normal / Low	Selects the amount of flash light (page 53).
<b>PFX (P.Effect)*</b>	Solarize / B&W / Sepia /Neg.Art / ■Off	Sets the special effects for the image (page 60).

\* When  (Camera) is set to [Auto], these items are not displayed.











### When the mode selector is set to (when [Moving Image] is set to [MPEG Movie] in the SET UP settings)

Item	Setting	Description
 (EV)	+2.0EV / +1.7EV / +1.3EV / +1.0EV / +0.7EV / +0.3EV / ■0EV / -0.3EV / -0.7EV / -1.0EV / -1.3EV / -1.7EV / -2.0EV	Adjusts the exposure (page 50).
 (Focus)	∞ / 7.0m / 3.0m / 1.0m / 0.5m / Center AF / ■ Multi AF	Chooses the auto focus method (page 48), or sets the focus preset distance (page 49).
 (Metering Mode) (DSC-P72 only)	Spot / ■ Multi	Selects the metering mode to suit the shooting conditions and purpose. (page 51).
<b>WB (White Bal)</b>	 /  /  /  / ■Auto	Sets the white balance (page 52).
<b>PFX (P.Effect)</b>	Solarize / B&W / Sepia /Neg.Art / ■Off	Sets the special effects for the image (page 60).

### When the mode selector is set to (when [Moving Image] is set to [Clip Motion] in the SET UP settings)

Item	Setting	Description
 (EV)	+2.0EV / +1.7EV / +1.3EV / +1.0EV / +0.7EV / +0.3EV /  0EV / -0.3EV / -0.7EV / -1.0EV / -1.3EV / -1.7EV / -2.0EV	Adjusts the exposure (page 50).
 (Focus)	$\infty$ / 7.0m / 3.0m / 1.0m / 0.5m / Center AF /  Multi AF	Chooses the auto focus method (page 48) or sets the focus preset distance (page 49).
 (Metering Mode) (DSC-P72 only)	Spot /  Multi	Selects the metering mode to suit the shooting conditions and purpose. (page 51).
WB (White Bal)	 /  Auto	Sets the white balance (page 52).
 $\pm$ (Flash Level)	High /  Normal / Low	Selects the amount of flash light (page 53).
PFX (P.Effect)	Solarize / B&W / Sepia / Neg.Art /  Off	Selects the special effects for the image (page 60).



### When the mode selector is set to (when [Moving Image] is set to [Multi Burst] in the SET UP settings)

Item	Setting	Description
 (EV)	+2.0EV / +1.7EV / +1.3EV / +1.0EV / +0.7EV / +0.3EV /  0EV / -0.3EV / -0.7EV / -1.0EV / -1.3EV / -1.7EV / -2.0EV	Adjusts the exposure (page 50).
 (Focus)	$\infty$ / 7.0m / 3.0m / 1.0m / 0.5m / Center AF /  Multi AF	Chooses the auto focus method (page 48) or sets the focus preset distance (page 49).
 (Metering Mode) (DSC-P72 only)	Spot /  Multi	Selects the metering mode to suit the shooting conditions and purpose. (page 51).
WB (White Bal)	 /  Auto	Sets the white balance (page 52).
 (Interval)	1/7.5 / 1/15 /  1/30 (NTSC) 1/6.3 / 1/12.5 /  1/25 (PAL)	<ul style="list-style-type: none"> <li>- In NTSC mode, choose the Multi Burst between-frame shutter interval.</li> <li>- In PAL mode, choose the Multi Burst between-frame shutter interval. <ul style="list-style-type: none"> <li>• The choices of between-frame shutter interval differ depending on the setting of the [Video Out] item in the SET UP setting (page 107).</li> </ul> </li> </ul>



Item	Setting	Description
 (P.Quality)	■Fine / Standard	Records images with fine image quality mode. / Records images in the standard image quality mode (page 46).
PFX (P.Effect)	Solarize / B&W / Sepia /Neg.Art / ■Off	Sets the special effects for the image (page 60).

### When the mode selector is set to

Item	Setting	Description
Folder	OK/Cancel	Select the folder that contains the images you want to play back (page 61).
Protect	—	Protects images against accidental erasure (page 67).
DPOF	—	Selects still images you want to attach/cancel the print (DPOF) mark (page 70).
Slide	Interval Image Repeat Start Cancel	<ul style="list-style-type: none"> <li>– Sets the slide show interval. (For single-image screen only.) ■3 sec/ 5 sec/ 10 sec/ 30 sec/ 1 min</li> <li>– Selects images from either folder or “Memory Stick.” ■Folder/All</li> <li>– Repeats the slide show. ■On/Off</li> <li>– Starts the slide show.</li> <li>– Cancels the settings and execution of the slide show.</li> </ul>
Resize	3.1M / 2.0M / 1.2M / VGA / Cancel	Changes the recorded image size (page 69). (For single-image screen only.)
Rotate	 (counter-clockwise) /  (clockwise) / OK / Cancel	Rotates the still image (page 64). (For single-image screen only.)
Divide	OK / Cancel	Divides a movie (page 76). (For single-image screen only.)

## SET UP items

Set the mode selector to SET UP. The SET UP screen appears.

Factory settings are indicated with ■.

### (Camera)

Item	Setting	Description
<b>Moving Image</b>	■MPEG Movie / Clip Motion / Multi Burst	Selects the shooting mode (pages 54, 55, 72).
<b>Smart Zoom (DSC-P52/P72 only)</b>	■On / Off	Selects whether to use the smart zoom (page 29).
<b>Date/Time</b>	Day&Time / Date / ■Off	Selects whether to insert the date and time into the image (page 35). When shooting movies, or images recorded in Clip Motion/Multi Burst modes, the date and time cannot be inserted in the image. Also, the date and time will not be displayed when shooting. The date and time will be displayed when the image is played back.
<b>Red Eye Reduction</b>	On / ■Off	Reduces the red-eye phenomenon when using a flash (page 33).
<b>AF Illuminator</b>	■Auto / Off	Selects whether to emit an AF assist light in the dark. Helps when it is hard to focus on the subject under dark lighting (page 33).

### (Memory Stick Tool)

Item	Setting	Description
<b>Format</b>	OK / Cancel	Formats the “Memory Stick.” Note that formatting erases all data on a “Memory Stick,” including even protected images (page 44).
<b>File Number</b>	■ Series Reset	<ul style="list-style-type: none"><li>– Assigns numbers to files in sequence even if the “Memory Stick” is changed or the recording folder is changed.</li><li>– Resets the file numbering and starts from 0001 each time the folder is changed. (When the recording folder contains a file, a number one higher than the largest number is assigned.)</li></ul>

Item	Setting	Description
<b>Create REC. Folder</b>	OK / Cancel	Creates a folder for recording images (page 46).
<b>Change REC. Folder</b>	OK / Cancel	Changes a folder for recording images (page 46).

### (Setup 1)

Item	Setting	Description
<b>Power Save</b>	■ On / Off	Selects whether to use the Power Save mode (page 17). Displayed only when you are using the camera with the batteries.
<b>LCD Brightness</b>	Bright/ ■Normal/ ■Dark	Selects the LCD brightness. This has no effect on the recorded images.
<b>LCD Backlight</b>	Bright/Normal/ ■Dark	Selects the brightness of the LCD backlight. Selecting [Bright] makes the screen bright and easy to see when using the camera outdoors or in other bright locations, but also uses up the battery charge faster. Displayed only when you are using the camera with the batteries.
<b>Beep</b>	Shutter ■ On Off	<ul style="list-style-type: none"> <li>– Turns on the shutter sound when you press the shutter button.</li> <li>– Turns on the beep/shutter sound when you press the control button/ press the shutter button.</li> <li>– Turns off the beep/shutter sound.</li> </ul>
 <b>Language</b>	—	Displays the menu items, warnings and messages in selected language.
<b>Clock Set</b>	OK / Cancel	Sets the date and time (pages 21, 45).

### (Setup 2)

Item	Setting	Description
<b>USB Connect</b>	PTP/■Normal	Switches the USB mode (page 78).
<b>Video Out</b>	NTSC PAL	<ul style="list-style-type: none"> <li>– Sets the video output signal to NTSC mode (e.g., Japan, USA).</li> <li>– Sets the video output signal to PAL mode (e.g., Europe).</li> </ul>

---

## Precautions

### Do not leave the camera in the following places

- In extremely hot place, such as in a car parked in the sun. The camera body may become deformed or this may cause a malfunction.
- Under direct sunlight or near a heater. The camera body may become deformed or this may cause a malfunction.
- On rocking vibration
- Near strong magnetic place
- On sandy or in dusty place  
Do not let sand get into the camera. Sand or dust may cause the camera to malfunction and sometimes this malfunction cannot be repaired.

### Cleaning

#### Cleaning the LCD screen

Clean the screen surface with an LCD cleaning kit (not supplied) to remove fingerprints, dust, etc.

#### Cleaning the lens

Wipe the lens with a soft cloth to remove fingerprints, dust, etc.

### Cleaning the camera surface

Clean the camera surface with a soft cloth slightly moistened with water, then wipe the surface with a dry cloth. Do not use the following as this may damage the finish or the casing.

- Thinner
- Benzine
- Alcohol
- Disposable cloth
- Volatile insecticide
- Contact with rubber or vinyl for a long time

### Note on operating temperature

The camera is designed for use within a temperature range of 0°C to 40°C (32°F to 104°F). Shooting in extremely cold or hot locations that exceed this range is not recommended.

### On moisture condensation

If the camera is brought directly from a cold to a warm location, or is placed in a very damp room, moisture may condense inside or outside the camera. This moisture condensation may cause a malfunction of the camera.

### Moisture condensation occurs easily when:

- The camera is brought from a cold location such as a ski slope into a warmly heated room.
- The camera is taken from an air-conditioned room or car interior to the hot outdoors, etc.

### To prevent moisture condensation

When bringing the camera from a cold place to a warm place, seal the camera in a plastic bag and leave it in the new location for about an hour. Remove the plastic bag when the camera has adapted to the new temperature.

### If moisture condensation occurs

Turn off the camera and wait about an hour for the moisture to evaporate. Note that if you attempt to shoot with moisture remaining inside the lens, you will be unable to record clear images.

## The internal rechargeable button battery

This camera has an internal rechargeable button battery for maintaining the date and time and other settings regardless of whether the power is on or off.

This rechargeable button battery is continually charged as long as you are using the camera. However, if you use the camera for only short periods it discharges gradually, and if you do not use the camera at all for about one month it becomes completely discharged. In this case, be sure to charge this rechargeable button battery before using the camera.

Note that even if this rechargeable button battery is not charged, you can still use the camera as long as you do not record the date and time.

## How to charge

Connect the camera to a wall outlet (wall socket) using the AC Adaptor (not supplied), or install charged batteries, and leave the camera for 24 hours or more with the power turned off.

## The “Memory Stick”

“Memory Stick” is a new compact, portable and versatile IC recording medium with a data capacity that exceeds the capacity of a floppy disk.

You can use the “Memory Stick” as an external recording media that can be attached or removed as well as exchanging data between the units.

There are two types of “Memory Stick”: an ordinary “Memory Stick” and a “MagicGate Memory Stick” that are equipped with the MagicGate copyright protection technology. You can use both types of “Memory Stick” with your camera. However, because your camera does not support the MagicGate standards, data recorded with your camera is not subject to MagicGate\* copyright protection.

You can also use the “Memory Stick Duo” and “Memory Stick PRO” with the camera.

- \* MagicGate is copyright protection technology that uses encryption technology.
- The “Memory Stick” formatted with a computer is not guaranteed to operate with this camera.

“Memory Stick”	Recording/Playback
Memory Stick (Memory Stick Duo)	○
MagicGate Memory Stick (MagicGate Memory Stick Duo)	○**
Memory Stick PRO	○**

- \*\* The camera cannot record or play back the data needed by the MagicGate function. We cannot ensure all of the functions of each “Memory Stick.”

## Notes on use of the “Memory Stick” (supplied)

- You cannot record, edit, or delete images when the write-protect switch is set to LOCK. The position or the shape of the write-protect switch may differ depending on the “Memory Stick” you use.

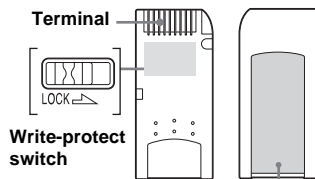

- Data may be damaged in the following cases:
  - Removing the “Memory Stick” or turning off the camera while reading or writing data.
  - Using the camera in a location subject to the effects of static electricity or noise.
- We recommend you back up any important data.
- Do not attach any other material than the supplied label on the labeling position.
- When you attach the supplied label, be sure to attach it to the labeling position. Be careful that the label does not stick out.
- When you carry or store the “Memory Stick,” put it in the case supplied with it.
- Do not touch the terminals of a “Memory Stick” with your hand or a metal object.

- Do not strike, bend or drop a “Memory Stick.”
- Do not disassemble or modify a “Memory Stick.”
- Do not expose the “Memory Stick” to water.
- Avoid using or storing the “Memory Stick” in the following places:
  - In a car parked in the sun, or at a high temperature.
  - Under direct sunlight.
  - In a humid place or near corrosive material.

### Notes on use of the “Memory Stick Duo” (not supplied)

- Be sure to insert the “Memory Stick Duo” into the “Memory Stick Duo” Adaptor when using the “Memory Stick Duo” with the camera.
- Verify that you are inserting the “Memory Stick Duo” in the proper direction when inserting it into the “Memory Stick Duo” Adaptor.
- Verify that you are inserting the “Memory Stick Duo” Adaptor in the proper direction when inserting it into the camera. Inserting it in the wrong direction may cause a malfunction.
- Do not insert a “Memory Stick Duo” that is not inserted into a “Memory Stick Duo” Adaptor into a “Memory Stick”-compatible unit. This may cause a malfunction of the unit.

### Note on use of the “Memory Stick PRO” (not supplied)

“Memory Stick PRO” with a capacity of up to 1 GB is verified for this camera.

---

## *The nickel-metal hydride batteries*

### Effective use of the battery

- Battery performance decreases in low-temperature surroundings, and the battery life is shortened under such circumstances. To use the battery longer, we recommend you keep the battery stored in the supplied battery case, in a pocket close to your body to warm it, and insert it in your camera just before you start shooting.
- If you shoot a lot using the zoom and flash, the battery power will be used up faster.
- We recommend having spare batteries handy for two or three times the expected shooting time, and try test shooting before the actually using the camera.
- Do not expose the battery to water. The battery is not water-resistant.

### Battery life

- The battery life is limited. Battery capacity decreases little by little as you use it more and more, and as time passes. When the battery operating time seems to have been considerably shortened, a probable cause is that the battery has reached the end of its life.
- The battery life varies depending on storage, operating conditions, and environment, and is different for each battery.

## The battery charger

- Do not charge any other batteries except the Sony nickel hydride battery using the supplied battery charger. If you charge other types of battery (manganese, alkaline, lithium, ni-cd batteries, etc.), this may cause leakage, explosion, or overheating of the battery, and personal scald or injury may be caused.
- Do not recharge a fully charged nickel hydride battery. This may cause leakage, explosion, or overheating of the battery.
- When charging a high capacity battery other than the supplied battery using the supplied battery charger, the full capacity of the battery may not be available.
- When the CHARGE lamp flashes, the battery may cause a malfunction if an unspecified battery was inserted. First, verify that the battery is specified for use with the charger. If the battery is specified for use with the charger, remove all the batteries from the battery charger, insert other batteries, such as new ones, and check that the battery charger works properly. When the battery charger works properly, the batteries may be the cause of the malfunction.

## Specifications

### ■ Camera

#### [System]

Image device 6.67 mm (1/2.7 type) color  
CCD  
Primary color filter

Total pixels number of camera  
Approx. 3 340 000 pixels

Effective pixels number of camera  
Approx. 3 210 000 pixels

Lens **DSC-P72**  
3× zoom lens  
f=6.0 to 18.0 mm  
(35 mm camera conversion: 39 to  
117mm (1 <sup>9</sup>/<sub>16</sub> to 4 <sup>5</sup>/<sub>8</sub> inches))

F2.8-5.6  
**DSC-P52**  
2× zoom lens  
f=6.3 to 12.6 mm  
(35 mm camera conversion: 41 to  
82 mm (1 <sup>5</sup>/<sub>8</sub> to 3 <sup>1</sup>/<sub>4</sub> inches))

F3.8  
**DSC-P32**  
Single focal lens  
f=5.0 mm  
(35 mm camera conversion: 33 mm  
(1 <sup>5</sup>/<sub>16</sub> inches))  
F2.8

Exposure control  
Automatic, Program, Twilight,  
Twilight portrait, Landscape, Snow,  
Beach

White balance  
Automatic, Daylight, Cloudy,  
Fluorescent, Incandescent

File format (DCF compliant)

Still images: Exif Ver. 2.2, JPEG  
compliant, GIF (for Clip Motion),  
DPOF compatible  
Audio with still image: MPEG1  
compliant (Monaural)  
Movies: MPEG1 compliant  
(Monaural)

Recording media

“Memory Stick”

Flash

Recommended distance

**DSC-P72**  
0.5 to 3.8 m (19 <sup>3</sup>/<sub>4</sub> inches to  
12 feet 5 <sup>19</sup>/<sub>32</sub> inches) (W)/  
0.5 to 2.5 m (19 <sup>3</sup>/<sub>4</sub> inches to  
8 feet 2 <sup>7</sup>/<sub>16</sub> inches) (T)

**DSC-P52**  
0.5 to 3.3 m (19 <sup>3</sup>/<sub>4</sub> inches to  
10 feet 9 <sup>29</sup>/<sub>32</sub> inches)

**DSC-P32**  
0.5 to 3.8 m (19 <sup>3</sup>/<sub>4</sub> inches to  
12 feet 5 <sup>19</sup>/<sub>32</sub> inches)  
(when ISO sensitivity is set to Auto)

### [Output connectors]

A/V OUT (MONO) jack (Monaural)

Minijack  
Video: 1 V<sub>p-p</sub>, 75 Ω, unbalanced,  
sync negative  
Audio: 327 mV (at a 47 kΩ load)  
Output impedance 2.2 kΩ

USB jack mini-B

### [LCD screen]

LCD panel used

**DSC-P72**  
3.8 cm (1.5 type) TFT drive  
**DSC-P52**  
4.0 cm (1.6 type) TFT drive

**DSC-P32**

4.0 cm (1.6 type) TFT drive

Total number of dots

**DSC-P72**

123 200 (560×220) dots

**DSC-P52**

61 600 (280×220) dots

**DSC-P32**

61 600 (280×220) dots

**[Power, general]**

Power AA nickel hydride batteries (2)  
2.4 V  
AC-LS5 AC Adaptor  
(not supplied), 4.2 V

Power consumption (when recording)

**DSC-P72**

1.7W

**DSC-P52**

1.6W

**DSC-P32**

1.7W

Operating temperature range

0° to +40°C (32° to +104°F)

Storage temperature range

-20° to +60°C (-4° to +140°F)

Dimensions

**DSC-P72**

119.5 × 57.7 × 32.6 mm

(4 <sup>3</sup>/<sub>4</sub> × 2 <sup>3</sup>/<sub>8</sub> × 1 <sup>5</sup>/<sub>16</sub> inches)**DSC-P52**

123.2 × 57.7 × 52 mm

(4 <sup>7</sup>/<sub>8</sub> × 2 <sup>3</sup>/<sub>8</sub> × 2 <sup>1</sup>/<sub>8</sub> inches)**DSC-P32**

101.3 × 57.7 × 32.6 mm

(4 × 2 <sup>3</sup>/<sub>8</sub> × 1 <sup>5</sup>/<sub>16</sub> inches)

(W/H/D, protruding portions not included)

Mass

**DSC-P72**

Approx. 259 g (9.1 oz) (two batteries, "Memory Stick" and wrist strap included)

**DSC-P52**

Approx. 280 g (9.9 oz) (two batteries, "Memory Stick" and wrist strap included)

**DSC-P32**

Approx. 217 g (7.7 oz) (two batteries, "Memory Stick" and wrist strap included)

Microphone Electret condenser microphone

Speaker Dynamic speaker

- Exif print Compatible
- PRINT image matching II Compatible

**■ BC-CS2A/CS2B Ni-MH battery charger**

Power requirements

AC 100 to 240V 50/60Hz

3 W

Output voltage

AA : DC 1.4 V 400 mA × 2

AAA : DC 1.4 V 160 mA × 2

Operating temperature range

0° to +40°C (32° to +104°F)

Dimensions

71 × 30 × 91 mm

(2 <sup>7</sup>/<sub>8</sub> × 1 <sup>3</sup>/<sub>16</sub> × 3 <sup>5</sup>/<sub>8</sub> inches) (W/H/D)

Mass

Approx. 90 g (3 oz)

**■ AC-LS5 AC Adaptor (not supplied)**

Power requirements

AC 100 to 240 V, 50/60 Hz

11 W 0.16 to 0.09 A

Rated output voltage

DC 4.2 V, 1.5 A

Operating temperature range

0° to +40°C (32° to +104°F)

Storage temperature range

-20° to +60°C (-4° to +140°F)

Maximum dimensions

Approx. 48 × 29 × 81 mm (1 <sup>15</sup>/<sub>16</sub> × 1 <sup>3</sup>/<sub>16</sub> × 3 <sup>1</sup>/<sub>4</sub> inches) (W/H/D)

Mass

Approx. 130 g (5 oz)

**Accessories**

- HR6 (size AA) Ni-MH batteries (2)
- Battery case
- BC-CS2A/CS2B Ni-MH Battery charger (1)
- Power cord (mains lead) (1)
- USB cable (1)
- A/V connecting cable (1)
- Wrist strap (1)
- "Memory Stick" (16MB) (1)
- CD-ROM (USB driver: SPVD-010) (1)
- Operating Instructions (1)

Design and specifications are subject to change without notice.



## The LCD screen

### For shooting still images

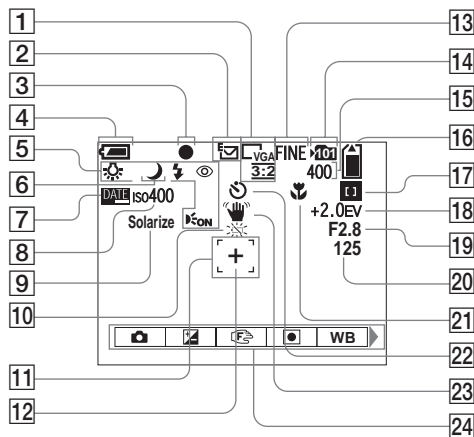

1 Image size indicator (24, 25)

2 Recording mode indicator (54–57)

3 AE/AF lock indicator (26, 49)

4 Battery remaining indicator (17)

5 Flash mode (32)/

Red-eye reduction (33)/

White balance indicator (52)/

AF illuminator indicator (33)

6 Camera mode indicator (27, 58)

7 Date/time indicator (35)

8 ISO sensitivity (102)

9 Picture effect indicator (60)

10 Low battery warning (98)

11 AF range finder (48)

12 Spot metering cross hair (51)

13 Image quality indicator (25, 46)

14 Recording folder indicator (46)

15 Remaining number of recordable images indicator (25)/

Self-diagnosis display (100)

16 Remaining "Memory Stick" capacity indicator

17 Center AF [L]/Multi AF [R] indicator (48)/

Focus preset value (49)

18 EV adjustment indicator (50)

19 Iris value indicator

20 Shutter speed indicator

21 Macro (DSC-P72) (30)

22 Self-timer indicator (31)

23 Vibration warning indicator (99)

24 Menu/Guide menu (45)

- Pressing the MENU button switches the menu/guide menu on/off.
-  (Metering Mode) is not displayed on the menu of the DSC-P52/P32.

The page numbers in parentheses indicate the location of additional important information.

## For shooting movies

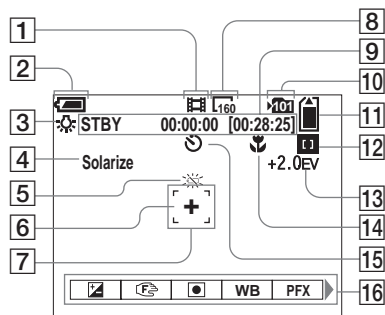

- 1 Recording mode indicator (72)
- 2 Battery remaining indicator (17)
- 3 White balance indicator (52)
- 4 Picture effect indicator (60)
- 5 Low battery warning (98)
- 6 Spot metering cross hair (51)
- 7 AF range finder (48)
- 8 Image size indicator (72)
- 9 Recording time (Maximum recordable time) indicator (101)/ Self-diagnosis display (100)
- 10 Recording folder indicator (46)
- 11 Remaining “Memory Stick” capacity indicator

- 12 Center AF [ ]/Multi AF [ ] indicator (48)/ Focus preset value (49)
- 13 EV adjustment indicator (50)
- 14 Macro (DSC-P72) (30)
- 15 Self-timer indicator (31)
- 16 Menu/Guide menu (45)

- Pressing the MENU button switches the menu/guide menu on/off.
-  (Metering Mode) is not displayed on the menu of the DSC-P52/P32.

## For still image playback

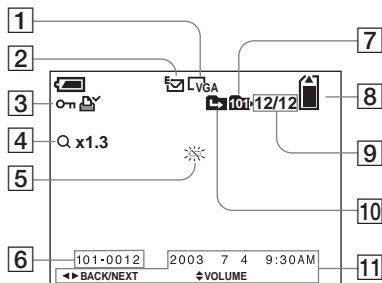

- 1 **Image size indicator** (24, 25)
- 2 **Recording mode indicator** (54–57)
- 3 **Volume indicator** (57)/**Protect mark indicator** (67)/**Print (DPOF) mark indicator** (70)
- 4 **Zoom indicator** (62)/**Jog playback indicator** (65)
- 5 **Low battery warning** (98)
- 6 **Folder-file number** (87)
- 7 **Playback folder indicator** (61)
- 8 **Remaining “Memory Stick” capacity indicator**
- 9 **Number of images recorded in the playback folder/Image number**
- 10 **Change folder indicator** (61)
- 11 **Recording date/time of the image** (21)/**Menu/Guide menu** (45)

## For movie playback

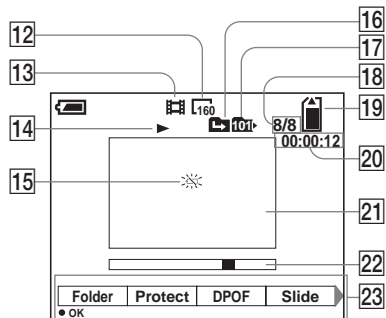

- 12 **Image size indicator** (73)
- 13 **Recording mode indicator** (73)
- 14 **Playback indicator** (73)/**Volume indicator** (73)
- 15 **Low battery warning** (98)
- 16 **Change folder indicator** (61)
- 17 **Playback folder indicator** (61)
- 18 **Image number/Number of images recorded in the playback folder**
- 19 **Remaining “Memory Stick” capacity indicator**
- 20 **Counter** (73)
- 21 **Playback screen** (73)
- 22 **Playback bar** (73)
- 23 **Menu/Guide menu** (45)

The page numbers in parentheses indicate the location of additional important information.

# Index

## A

A/V connecting cable .....	38
Access lamp .....	23
AE/AF lock .....	26, 49
AE/AF lock lamp .....	9, 11, 13
AF illuminator .....	8, 10, 12, 33
AF lock .....	26, 49
Auto focus mode .....	28, 48
Auto Power Off feature .....	20

## B

Battery	
Battery life .....	17
Charging the battery .....	14
Charging time .....	15
Remaining indicator .....	17
Beep/shutter sound .....	107

## C

Changing the recording folder .....	47
Charging	
Charging the battery .....	14
Charging time .....	15
Cleaning .....	108
Computer	
Copying images to your computer .....	78, 88
USB cable .....	82
USB driver .....	79, 88
Control button .....	20
Creating a new folder .....	47

## D

Date and time .....	21, 35
DC plug .....	19
Deleting images .....	40, 74
Divide .....	76

## E

Editing still images	
Print (DPOF) mark .....	70
Protect .....	67
Resize .....	69
E-Mail .....	56
EV adjustment .....	50
Exposure	
EV adjustment .....	50

## F

File	
File names .....	87
Image file storage destinations .....	86
Finder .....	34
Flash	
Daylight synchro .....	32
Flash Level .....	53
Red Eye Reduction .....	33
Selecting a flash mode .....	32

## Focus

AE/AF lock lamp .....	9, 11, 13
AF lock .....	26, 49
Focus preset .....	49
Folder	
Folder for playback .....	61
Recording folder .....	47
Format .....	44

## G

GIF .....	54, 87
-----------	--------

## I

Image	
Copying images to your computer .....	78, 88
File names .....	87
Image file storage destinations .....	86
Image quality .....	25, 46
Image size .....	24, 25, 101
Image Transfer .....	80, 83
ImageMixer .....	81
Index screen .....	36
Installation .....	79, 88
ISO .....	102

## J

JPG .....	87
-----------	----

## L

LCD	
LCD brightness .....	107
LCD screen display .....	113, 114, 115
LCD status/LCD on/off .....	34

## M

Memory Stick	
Formatting a Memory Stick .....	44
Inserting a Memory Stick .....	23
Number of shooting images .....	25
The number of images that can be saved/ shooting time .....	25, 101

Menu		Smart zoom	29
Changing menu	45	Spot metering	51
Metering mode	51	The number of images that can be saved/ shooting time	17, 25, 101
Mode selector	9, 11, 13	Using auto mode	26
Moisture condensation	108	Using the self-timer	31
Movie		White balance	52
Continuous shooting	18		
Cutting movies	76		
Deleting movies	74		
Shooting movies	72		
Viewing	73		
MPG	87		
<b>N</b>			
NR slow shutter	59		
NTSC	107		
<b>P</b>			
PAL	107		
Picture effect	60		
Power			
An external power source	19		
Battery	14		
Inserting battery	16		
On/Off	20		
Precautions	108		
<b>R</b>			
Red Eye Reduction	33		
RESET button	91		
<b>S</b>			
Self-diagnosis display	100		
Self-timer	31		
Setting			
Changing menu	45		
Date and time	21		
Image size	24		
SET UP	45		
Shooting close-ups (Macro)	30		
Shooting mode			
Clip Motion	54		
E-Mail	56		
MPEG Movie	72		
Shooting (using auto mode)	26		
Shooting according to scene conditions	58		
Shooting in Multi Burst mode	55		
Voice	57		
Shooting with the date and time inserted	35		
Still image playback			
Index (nine or triple-image) screen	36		
Playback zoom	62		
Quick Review	28		
Rotate	64		
Slide show	63		
Viewing images on a TV screen	38		
Viewing on the single-image screen	36		
Viewing the images on your computer	85, 89		
Still image shooting			
Auto focus mode	28, 48		
EV adjustment	50		
Image size	24, 25, 101		
Inserting the date and time	35		
Number of shooting images	25		
Picture effect	60		
Selecting a flash mode	32		
Shooting close-ups (Macro)	30		
		<b>T</b>	
		Trimming	63
		<b>U</b>	
		USB	
		Cancel the USB connection	83, 89
		Installing the USB driver	79, 88
		USB connection	82, 88
		Using your camera abroad	19
		<b>V</b>	
		Viewing on the single-image screen	36
		Voice	57
		<b>W</b>	
		Warnings and messages	98
		White balance	52
		<b>Z</b>	
		Zoom	
		Playback zoom	62
		Using the zoom feature	29







Printed on 100% recycled paper  
using VOC (Volatile Organic  
Compound)-free vegetable oil  
based ink.

<http://www.sony.net/>

Sony Corporation Printed in Japan

Additional information on this product and answers to frequent  
asked questions can be found at our Customer Support Website.